

Mark For: _____
 Date: _____
 Dealer Acct #: _____
 Dealer: _____
 Dealer Contact: _____
 Dealer Address: _____
 Dealer City: _____ Prov: _____ PC: _____
 Dealer Phone: () _____ Fax: () _____
 Confirmation Email: _____
 Confirm Via: Fax Email

Submitting for: Quote Order
 PO#: _____
ADDITIONAL SHIPPING INFORMATION
 Ship To: _____
 Attention: _____
 Address: _____
 Address: _____
 Ship To City: _____ Prov: _____ PC: _____
 Ship To Phone: () _____ Fax: () _____

JAY J3 Posterior (PA) Back



BACKREST WIDTH	12"	14"	16"	18"	20"
BACKCANE WIDTHS	12"- 14"	14"- 16"	16"- 18"	18"- 20"	20"- 22"
MAX. USER TRUNK WIDTH	11"	13"	15"	17"	19"

Backrest Height	Backrest Style	Backrest Width									
		12"	14"	16"	18"	20"	12"	14"	16"	18"	20"
Lower Thoracic (LT)											
6.5" (S)	J3PALTSxxSH	<input type="checkbox"/>	<input type="checkbox"/>	<input type="checkbox"/>	<input type="checkbox"/>	<input type="checkbox"/>	<input type="checkbox"/>	<input type="checkbox"/>	<input type="checkbox"/>	<input type="checkbox"/>	<input type="checkbox"/>
	J3PALTSxxRH	<input type="checkbox"/>	<input type="checkbox"/>	<input type="checkbox"/>	<input type="checkbox"/>	<input type="checkbox"/>	<input type="checkbox"/>	<input type="checkbox"/>	<input type="checkbox"/>	<input type="checkbox"/>	
	J3PALTSxxRHF	<input type="checkbox"/>	<input type="checkbox"/>	<input type="checkbox"/>	<input type="checkbox"/>	<input type="checkbox"/>	<input type="checkbox"/>	<input type="checkbox"/>	<input type="checkbox"/>	<input type="checkbox"/>	
	J3PALTMxxSH	<input type="checkbox"/>	<input type="checkbox"/>	<input type="checkbox"/>	<input type="checkbox"/>	<input type="checkbox"/>	<input type="checkbox"/>	<input type="checkbox"/>	<input type="checkbox"/>	<input type="checkbox"/>	
	J3PALTMxxRH	<input type="checkbox"/>	<input type="checkbox"/>	<input type="checkbox"/>	<input type="checkbox"/>	<input type="checkbox"/>	<input type="checkbox"/>	<input type="checkbox"/>	<input type="checkbox"/>	<input type="checkbox"/>	
	J3PALTMxxRHF	<input type="checkbox"/>	<input type="checkbox"/>	<input type="checkbox"/>	<input type="checkbox"/>	<input type="checkbox"/>	<input type="checkbox"/>	<input type="checkbox"/>	<input type="checkbox"/>	<input type="checkbox"/>	
	J3PALTTxxSH	<input type="checkbox"/>	<input type="checkbox"/>	<input type="checkbox"/>	<input type="checkbox"/>	<input type="checkbox"/>	<input type="checkbox"/>	<input type="checkbox"/>	<input type="checkbox"/>	<input type="checkbox"/>	
	J3PALTTxxRH	<input type="checkbox"/>	<input type="checkbox"/>	<input type="checkbox"/>	<input type="checkbox"/>	<input type="checkbox"/>	<input type="checkbox"/>	<input type="checkbox"/>	<input type="checkbox"/>	<input type="checkbox"/>	
	J3PALTTxxRHF	<input type="checkbox"/>	<input type="checkbox"/>	<input type="checkbox"/>	<input type="checkbox"/>	<input type="checkbox"/>	<input type="checkbox"/>	<input type="checkbox"/>	<input type="checkbox"/>	<input type="checkbox"/>	
Mid Thoracic (MT)											
12.0" (S)	J3PAMTSxxSH	<input type="checkbox"/>	<input type="checkbox"/>	<input type="checkbox"/>	<input type="checkbox"/>	<input type="checkbox"/>	<input type="checkbox"/>	<input type="checkbox"/>	<input type="checkbox"/>	<input type="checkbox"/>	
	J3PAMTSxxFS	<input type="checkbox"/>	<input type="checkbox"/>	<input type="checkbox"/>	<input type="checkbox"/>	<input type="checkbox"/>	<input type="checkbox"/>	<input type="checkbox"/>	<input type="checkbox"/>	<input type="checkbox"/>	
	J3PAMTSxxTH	<input type="checkbox"/>	<input type="checkbox"/>	<input type="checkbox"/>	<input type="checkbox"/>	<input type="checkbox"/>	<input type="checkbox"/>	<input type="checkbox"/>	<input type="checkbox"/>	<input type="checkbox"/>	
	J3PAMTMxxSH	<input type="checkbox"/>	<input type="checkbox"/>	<input type="checkbox"/>	<input type="checkbox"/>	<input type="checkbox"/>	<input type="checkbox"/>	<input type="checkbox"/>	<input type="checkbox"/>	<input type="checkbox"/>	
	J3PAMTMxxFS	<input type="checkbox"/>	<input type="checkbox"/>	<input type="checkbox"/>	<input type="checkbox"/>	<input type="checkbox"/>	<input type="checkbox"/>	<input type="checkbox"/>	<input type="checkbox"/>	<input type="checkbox"/>	
	J3PAMTMxxTH	<input type="checkbox"/>	<input type="checkbox"/>	<input type="checkbox"/>	<input type="checkbox"/>	<input type="checkbox"/>	<input type="checkbox"/>	<input type="checkbox"/>	<input type="checkbox"/>	<input type="checkbox"/>	
	J3PAMTTxxSH	<input type="checkbox"/>	<input type="checkbox"/>	<input type="checkbox"/>	<input type="checkbox"/>	<input type="checkbox"/>	<input type="checkbox"/>	<input type="checkbox"/>	<input type="checkbox"/>	<input type="checkbox"/>	
	J3PAMTTxxFS	<input type="checkbox"/>	<input type="checkbox"/>	<input type="checkbox"/>	<input type="checkbox"/>	<input type="checkbox"/>	<input type="checkbox"/>	<input type="checkbox"/>	<input type="checkbox"/>	<input type="checkbox"/>	
	J3PAMTTxxTH	<input type="checkbox"/>	<input type="checkbox"/>	<input type="checkbox"/>	<input type="checkbox"/>	<input type="checkbox"/>	<input type="checkbox"/>	<input type="checkbox"/>	<input type="checkbox"/>	<input type="checkbox"/>	
Upper Thoracic (UT)											
16.5" (S)	J3PAUTSxxSH	<input type="checkbox"/>	<input type="checkbox"/>	<input type="checkbox"/>	<input type="checkbox"/>	<input type="checkbox"/>	<input type="checkbox"/>	<input type="checkbox"/>	<input type="checkbox"/>	<input type="checkbox"/>	
	J3PAUTSxxFS	<input type="checkbox"/>	<input type="checkbox"/>	<input type="checkbox"/>	<input type="checkbox"/>	<input type="checkbox"/>	<input type="checkbox"/>	<input type="checkbox"/>	<input type="checkbox"/>	<input type="checkbox"/>	
	J3PAUTSxxTH	<input type="checkbox"/>	<input type="checkbox"/>	<input type="checkbox"/>	<input type="checkbox"/>	<input type="checkbox"/>	<input type="checkbox"/>	<input type="checkbox"/>	<input type="checkbox"/>	<input type="checkbox"/>	
	J3PAUTMxxSH	<input type="checkbox"/>	<input type="checkbox"/>	<input type="checkbox"/>	<input type="checkbox"/>	<input type="checkbox"/>	<input type="checkbox"/>	<input type="checkbox"/>	<input type="checkbox"/>	<input type="checkbox"/>	
	J3PAUTMxxFS	<input type="checkbox"/>	<input type="checkbox"/>	<input type="checkbox"/>	<input type="checkbox"/>	<input type="checkbox"/>	<input type="checkbox"/>	<input type="checkbox"/>	<input type="checkbox"/>	<input type="checkbox"/>	
	J3PAUTMxxTH	<input type="checkbox"/>	<input type="checkbox"/>	<input type="checkbox"/>	<input type="checkbox"/>	<input type="checkbox"/>	<input type="checkbox"/>	<input type="checkbox"/>	<input type="checkbox"/>	<input type="checkbox"/>	
	J3PAUTTxxSH	<input type="checkbox"/>	<input type="checkbox"/>	<input type="checkbox"/>	<input type="checkbox"/>	<input type="checkbox"/>	<input type="checkbox"/>	<input type="checkbox"/>	<input type="checkbox"/>	<input type="checkbox"/>	
	J3PAUTTxxFS	<input type="checkbox"/>	<input type="checkbox"/>	<input type="checkbox"/>	<input type="checkbox"/>	<input type="checkbox"/>	<input type="checkbox"/>	<input type="checkbox"/>	<input type="checkbox"/>	<input type="checkbox"/>	
	J3PAUTTxxTH	<input type="checkbox"/>	<input type="checkbox"/>	<input type="checkbox"/>	<input type="checkbox"/>	<input type="checkbox"/>	<input type="checkbox"/>	<input type="checkbox"/>	<input type="checkbox"/>	<input type="checkbox"/>	
Shoulder Height (SH)											
21.0" (S)	J3PASHSxxSH	<input type="checkbox"/>	<input type="checkbox"/>	<input type="checkbox"/>	<input type="checkbox"/>	<input type="checkbox"/>	<input type="checkbox"/>	<input type="checkbox"/>	<input type="checkbox"/>	<input type="checkbox"/>	
	J3PASHSxxFS	<input type="checkbox"/>	<input type="checkbox"/>	<input type="checkbox"/>	<input type="checkbox"/>	<input type="checkbox"/>	<input type="checkbox"/>	<input type="checkbox"/>	<input type="checkbox"/>	<input type="checkbox"/>	
	J3PASHSxxTH	<input type="checkbox"/>	<input type="checkbox"/>	<input type="checkbox"/>	<input type="checkbox"/>	<input type="checkbox"/>	<input type="checkbox"/>	<input type="checkbox"/>	<input type="checkbox"/>	<input type="checkbox"/>	
	J3PASHMxxSH	<input type="checkbox"/>	<input type="checkbox"/>	<input type="checkbox"/>	<input type="checkbox"/>	<input type="checkbox"/>	<input type="checkbox"/>	<input type="checkbox"/>	<input type="checkbox"/>	<input type="checkbox"/>	
	J3PASHMxxFS	<input type="checkbox"/>	<input type="checkbox"/>	<input type="checkbox"/>	<input type="checkbox"/>	<input type="checkbox"/>	<input type="checkbox"/>	<input type="checkbox"/>	<input type="checkbox"/>	<input type="checkbox"/>	
	J3PASHMxxTH	<input type="checkbox"/>	<input type="checkbox"/>	<input type="checkbox"/>	<input type="checkbox"/>	<input type="checkbox"/>	<input type="checkbox"/>	<input type="checkbox"/>	<input type="checkbox"/>	<input type="checkbox"/>	
	J3PASHTxxSH	<input type="checkbox"/>	<input type="checkbox"/>	<input type="checkbox"/>	<input type="checkbox"/>	<input type="checkbox"/>	<input type="checkbox"/>	<input type="checkbox"/>	<input type="checkbox"/>	<input type="checkbox"/>	
	J3PASHTxxFS	<input type="checkbox"/>	<input type="checkbox"/>	<input type="checkbox"/>	<input type="checkbox"/>	<input type="checkbox"/>	<input type="checkbox"/>	<input type="checkbox"/>	<input type="checkbox"/>	<input type="checkbox"/>	
	J3PASHTxxTH	<input type="checkbox"/>	<input type="checkbox"/>	<input type="checkbox"/>	<input type="checkbox"/>	<input type="checkbox"/>	<input type="checkbox"/>	<input type="checkbox"/>	<input type="checkbox"/>	<input type="checkbox"/>	

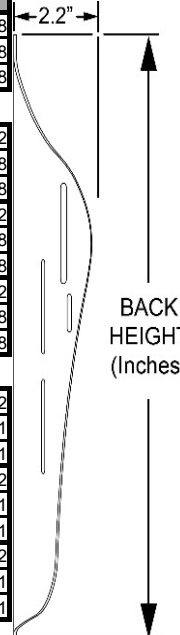

MOUNTING HARDWARE OPTIONS

- SH: [Diagram of SH hardware]
- RH: [Diagram of RH hardware]
- RHF: [Diagram of RHF hardware]
- TH: [Diagram of TH hardware]
- FS: [Diagram of FS hardware]

Note: Hardware choices are not offered on every size of J3 Backrest, only options listed above are available.
 Note: For 22"-26" Wide J3 backs please see the J3 Plus Backrest Order Form on www.SunriseMedical.ca

April 2025

Mark For: _____
 Date: _____
 Dealer Acct #: _____
 Dealer: _____
 Dealer Contact: _____
 Dealer Address: _____
 Dealer City: _____ Prov: _____ PC: _____
 Dealer Phone: () _____ Fax: () _____
 Confirmation Email: _____
 Confirm Via: Fax Email

Submitting for: Quote Order
 PO#: _____
ADDITIONAL SHIPPING INFORMATION
 Ship To: _____
 Attention: _____
 Address: _____
 Address: _____
 Ship To City: _____ Prov _____ PC: _____
 Ship To Phone: () _____ Fax: () _____

JAY J3 Posterior Lateral (PL) Back



BACKREST WIDTH	12"	14"	16"	18"	20"
BACKCANE WIDTHS	12"- 14"	14"- 16"	16"- 18"	18"- 20"	20"- 22"
MAX. USER TRUNK WIDTH	9.5"	11.5"	13.5"	15.5"	17.5"

Back Height	Lower Thoracic (LT)		X	Y																
		6.5" (S)																		
		8" (M)																		
		9.5" (T)																		
	Mid Thoracic (MT)		X	Y																
		12.0" (S)	4.5"	5.5"	J3PLMTSxxSH	<input type="checkbox"/>	12	\$902	<input type="checkbox"/>	14	\$902	<input type="checkbox"/>	16	\$902	<input type="checkbox"/>	18	\$902	<input type="checkbox"/>	20	\$902
			J3PLMTSxxFS	<input type="checkbox"/>	12	\$979	<input type="checkbox"/>	14	\$979	<input type="checkbox"/>	16	\$979	<input type="checkbox"/>	18	\$979	<input type="checkbox"/>	20	\$979		
			J3PLMTSxxTH	<input type="checkbox"/>	12	\$979	<input type="checkbox"/>	14	\$979	<input type="checkbox"/>	16	\$979	<input type="checkbox"/>	18	\$979	<input type="checkbox"/>	20	\$979		
		13.5" (M)	4.5"	7.0"	J3PLMTMxxSH	<input type="checkbox"/>	12	\$902	<input type="checkbox"/>	14	\$902	<input type="checkbox"/>	16	\$902	<input type="checkbox"/>	18	\$902	<input type="checkbox"/>	20	\$902
			J3PLMTMxxFS	<input type="checkbox"/>	12	\$979	<input type="checkbox"/>	14	\$979	<input type="checkbox"/>	16	\$979	<input type="checkbox"/>	18	\$979	<input type="checkbox"/>	20	\$979		
			J3PLMTMxxTH	<input type="checkbox"/>	12	\$979	<input type="checkbox"/>	14	\$979	<input type="checkbox"/>	16	\$979	<input type="checkbox"/>	18	\$979	<input type="checkbox"/>	20	\$979		
		15.0" (T)	4.5"	8.5"	J3PLMTTxxSH	<input type="checkbox"/>	12	\$902	<input type="checkbox"/>	14	\$902	<input type="checkbox"/>	16	\$902	<input type="checkbox"/>	18	\$902	<input type="checkbox"/>	20	\$902
			J3PLMTTxxFS	<input type="checkbox"/>	12	\$979	<input type="checkbox"/>	14	\$979	<input type="checkbox"/>	16	\$979	<input type="checkbox"/>	18	\$979	<input type="checkbox"/>	20	\$979		
			J3PLMTTxxTH	<input type="checkbox"/>	12	\$979	<input type="checkbox"/>	14	\$979	<input type="checkbox"/>	16	\$979	<input type="checkbox"/>	18	\$979	<input type="checkbox"/>	20	\$979		
	Upper Thoracic (UT)		X	Y																
	16.5" (S)	5.5"	7.5"	J3PLUTSxxSH	<input type="checkbox"/>	12	\$986	<input type="checkbox"/>	14	\$986	<input type="checkbox"/>	16	\$986	<input type="checkbox"/>	18	\$986	<input type="checkbox"/>	20	\$986	
		J3PLUTSxxFS	<input type="checkbox"/>	12	\$1,063	<input type="checkbox"/>	14	\$1,063	<input type="checkbox"/>	16	\$1,063	<input type="checkbox"/>	18	\$1,063	<input type="checkbox"/>	20	\$1,063			
		J3PLUTSxxTH	<input type="checkbox"/>	12	\$1,063	<input type="checkbox"/>	14	\$1,063	<input type="checkbox"/>	16	\$1,063	<input type="checkbox"/>	18	\$1,063	<input type="checkbox"/>	20	\$1,063			
	18.0" (M)	5.5"	8.5"	J3PLUTMxxSH	<input type="checkbox"/>	14	\$986	<input type="checkbox"/>	16	\$986	<input type="checkbox"/>	18	\$986	<input type="checkbox"/>	20	\$986				
		J3PLUTMxxFS	<input type="checkbox"/>	14	\$1,063	<input type="checkbox"/>	16	\$1,063	<input type="checkbox"/>	18	\$1,063	<input type="checkbox"/>	20	\$1,063						
		J3PLUTMxxTH	<input type="checkbox"/>	14	\$1,063	<input type="checkbox"/>	16	\$1,063	<input type="checkbox"/>	18	\$1,063	<input type="checkbox"/>	20	\$1,063						
	19.5" (T)	5.5"	9.5"	J3PLUTTxxSH	<input type="checkbox"/>	14	\$986	<input type="checkbox"/>	16	\$986	<input type="checkbox"/>	18	\$986	<input type="checkbox"/>	20	\$986				
		J3PLUTTxxFS	<input type="checkbox"/>	14	\$1,063	<input type="checkbox"/>	16	\$1,063	<input type="checkbox"/>	18	\$1,063	<input type="checkbox"/>	20	\$1,063						
		J3PLUTTxxTH	<input type="checkbox"/>	14	\$1,063	<input type="checkbox"/>	16	\$1,063	<input type="checkbox"/>	18	\$1,063	<input type="checkbox"/>	20	\$1,063						
Shoulder Height (SH)		X	Y																	
	21.0" (S)	5.5"	8.5"	J3PLSHSxxSH	<input type="checkbox"/>	14	\$1,015	<input type="checkbox"/>	16	\$1,015	<input type="checkbox"/>	18	\$1,015	<input type="checkbox"/>	20	\$1,015				
		J3PLSHSxxFS	<input type="checkbox"/>	14	\$1,092	<input type="checkbox"/>	16	\$1,092	<input type="checkbox"/>	18	\$1,092	<input type="checkbox"/>	20	\$1,092						
		J3PLSHSxxTH	<input type="checkbox"/>	14	\$1,092	<input type="checkbox"/>	16	\$1,092	<input type="checkbox"/>	18	\$1,092	<input type="checkbox"/>	20	\$1,092						
	22.5" (M)	5.5"	9.5"	J3PLSHMxxSH	<input type="checkbox"/>	16	\$1,015	<input type="checkbox"/>	18	\$1,015	<input type="checkbox"/>	20	\$1,015							
		J3PLSHMxxFS	<input type="checkbox"/>	16	\$1,092	<input type="checkbox"/>	18	\$1,092	<input type="checkbox"/>	20	\$1,092									
		J3PLSHMxxTH	<input type="checkbox"/>	16	\$1,092	<input type="checkbox"/>	18	\$1,092	<input type="checkbox"/>	20	\$1,092									
	24.0" (T)	5.5"	10.5"	J3PLSHTxxSH	<input type="checkbox"/>	18	\$1,015	<input type="checkbox"/>	20	\$1,015										
		J3PLSHTxxFS	<input type="checkbox"/>	18	\$1,092	<input type="checkbox"/>	20	\$1,092												
		J3PLSHTxxTH	<input type="checkbox"/>	18	\$1,092	<input type="checkbox"/>	20	\$1,092												

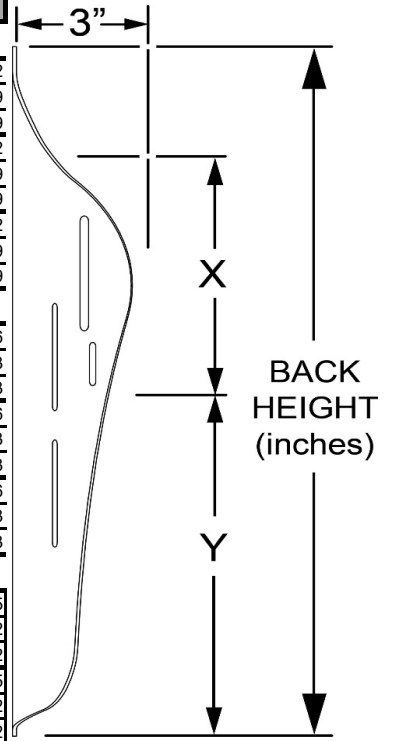

Note: Hardware choices are not offered on every size of J3 Backrest, only options listed above are available.

MOUNTING HARDWARE OPTIONS

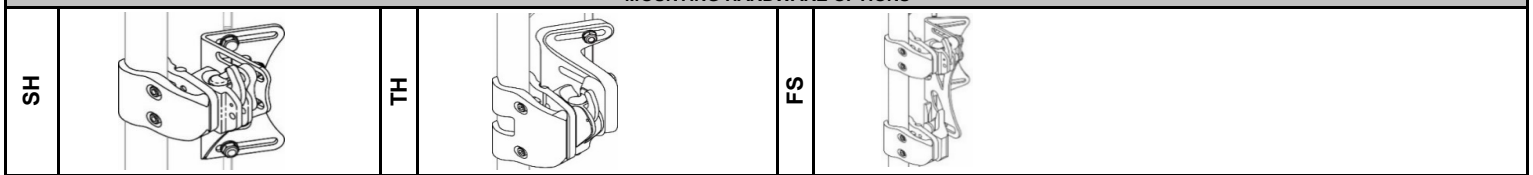

Mark For: _____
 Date: _____
 Dealer Acct #: _____
 Dealer: _____
 Dealer Contact: _____
 Dealer Address: _____
 Dealer City: _____ Prov: _____ PC: _____
 Dealer Phone: () _____ Fax: () _____
 Confirmation Email: _____
 Confirm Via: Fax Email

Submitting for: Quote Order
 PO#: _____
ADDITIONAL SHIPPING INFORMATION
 Ship To: _____
 Attention: _____
 Address: _____
 Address: _____
 Ship To City: _____ Prov _____ PC _____
 Ship To Phone: () _____ Fax: () _____

JAY J3 Posterior Deep (PD) Back



BACKREST WIDTH	12"	14"	16"	18"	20"
BACKCANE WIDTHS	12"- 14"	14"- 16"	16"- 18"	18"- 20"	20"- 22"
MAX. USER TRUNK WIDTH	11"	11"	13"	15"	17"

Back Height	Lower Thoracic (LT)																		
		6.5" (S)																	
	8.0" (M)	J3PDLTMxxSH		<input type="checkbox"/> 14 \$995	<input type="checkbox"/> 16 \$995	<input type="checkbox"/> 18 \$995													
		J3PDLTMxxRH		<input type="checkbox"/> 14 \$1,073	<input type="checkbox"/> 16 \$1,073	<input type="checkbox"/> 18 \$1,073													
		J3PDLTMxxRHF		<input type="checkbox"/> 14 \$1,073	<input type="checkbox"/> 16 \$1,073	<input type="checkbox"/> 18 \$1,073													
	9.5" (T)	J3PDLTTxxSH		<input type="checkbox"/> 14 \$995	<input type="checkbox"/> 16 \$995	<input type="checkbox"/> 18 \$995	<input type="checkbox"/> 20 \$995												
		J3PDLTTxxRH		<input type="checkbox"/> 14 \$1,073	<input type="checkbox"/> 16 \$1,073	<input type="checkbox"/> 18 \$1,073	<input type="checkbox"/> 20 \$1,073												
		J3PDLTTxxRHF		<input type="checkbox"/> 14 \$1,073	<input type="checkbox"/> 16 \$1,073	<input type="checkbox"/> 18 \$1,073	<input type="checkbox"/> 20 \$1,073												
	Mid Thoracic (MT)																		
	12.0" (S)	J3PDMTSxxSH	<input type="checkbox"/> 12 \$995	<input type="checkbox"/> 14 \$995	<input type="checkbox"/> 16 \$995	<input type="checkbox"/> 18 \$995	<input type="checkbox"/> 20 \$995												
		J3PDMTSxxFS	<input type="checkbox"/> 12 \$1,073	<input type="checkbox"/> 14 \$1,073	<input type="checkbox"/> 16 \$1,073	<input type="checkbox"/> 18 \$1,073	<input type="checkbox"/> 20 \$1,073												
		J3PDMTSxxTH	<input type="checkbox"/> 12 \$1,073	<input type="checkbox"/> 14 \$1,073	<input type="checkbox"/> 16 \$1,073	<input type="checkbox"/> 18 \$1,073	<input type="checkbox"/> 20 \$1,073												
	13.5" (M)	J3PDMTMxxSH	<input type="checkbox"/> 12 \$995	<input type="checkbox"/> 14 \$995	<input type="checkbox"/> 16 \$995	<input type="checkbox"/> 18 \$995	<input type="checkbox"/> 20 \$995												
		J3PDMTMxxFS	<input type="checkbox"/> 12 \$1,073	<input type="checkbox"/> 14 \$1,073	<input type="checkbox"/> 16 \$1,073	<input type="checkbox"/> 18 \$1,073	<input type="checkbox"/> 20 \$1,073												
		J3PDMTMxxTH	<input type="checkbox"/> 12 \$1,073	<input type="checkbox"/> 14 \$1,073	<input type="checkbox"/> 16 \$1,073	<input type="checkbox"/> 18 \$1,073	<input type="checkbox"/> 20 \$1,073												
	15.0" (T)	J3PDMTTxxSH	<input type="checkbox"/> 12 \$995	<input type="checkbox"/> 14 \$995	<input type="checkbox"/> 16 \$995	<input type="checkbox"/> 18 \$995	<input type="checkbox"/> 20 \$995												
		J3PDMTTxxFS	<input type="checkbox"/> 12 \$1,073	<input type="checkbox"/> 14 \$1,073	<input type="checkbox"/> 16 \$1,073	<input type="checkbox"/> 18 \$1,073	<input type="checkbox"/> 20 \$1,073												
		J3PDMTTxxTH	<input type="checkbox"/> 12 \$1,073	<input type="checkbox"/> 14 \$1,073	<input type="checkbox"/> 16 \$1,073	<input type="checkbox"/> 18 \$1,073	<input type="checkbox"/> 20 \$1,073												
	Upper Thoracic (UT)																		
	16.5" (S)	J3PDUTSxxSH	<input type="checkbox"/> 12 \$1,081	<input type="checkbox"/> 14 \$1,081	<input type="checkbox"/> 16 \$1,081	<input type="checkbox"/> 18 \$1,081	<input type="checkbox"/> 20 \$1,081												
		J3PDUTSxxFS	<input type="checkbox"/> 12 \$1,159	<input type="checkbox"/> 14 \$1,159	<input type="checkbox"/> 16 \$1,159	<input type="checkbox"/> 18 \$1,159	<input type="checkbox"/> 20 \$1,159												
		J3PDUTSxxTH	<input type="checkbox"/> 12 \$1,159	<input type="checkbox"/> 14 \$1,159	<input type="checkbox"/> 16 \$1,159	<input type="checkbox"/> 18 \$1,159	<input type="checkbox"/> 20 \$1,159												
	18.0" (M)	J3PDUTMxxSH		<input type="checkbox"/> 14 \$1,081	<input type="checkbox"/> 16 \$1,081	<input type="checkbox"/> 18 \$1,081	<input type="checkbox"/> 20 \$1,081												
		J3PDUTMxxFS		<input type="checkbox"/> 14 \$1,159	<input type="checkbox"/> 16 \$1,159	<input type="checkbox"/> 18 \$1,159	<input type="checkbox"/> 20 \$1,159												
		J3PDUTMxxTH		<input type="checkbox"/> 14 \$1,159	<input type="checkbox"/> 16 \$1,159	<input type="checkbox"/> 18 \$1,159	<input type="checkbox"/> 20 \$1,159												
	19.5" (T)	J3PDUTTxxSH		<input type="checkbox"/> 14 \$1,081	<input type="checkbox"/> 16 \$1,081	<input type="checkbox"/> 18 \$1,081	<input type="checkbox"/> 20 \$1,081												
		J3PDUTTxxFS		<input type="checkbox"/> 14 \$1,159	<input type="checkbox"/> 16 \$1,159	<input type="checkbox"/> 18 \$1,159	<input type="checkbox"/> 20 \$1,159												
		J3PDUTTxxTH		<input type="checkbox"/> 14 \$1,159	<input type="checkbox"/> 16 \$1,159	<input type="checkbox"/> 18 \$1,159	<input type="checkbox"/> 20 \$1,159												
	Shoulder Height (SH)																		
	21.0" (S)	J3PDSHSxxSH		<input type="checkbox"/> 14 \$1,160	<input type="checkbox"/> 16 \$1,160	<input type="checkbox"/> 18 \$1,160	<input type="checkbox"/> 20 \$1,160												
		J3PDSHSxxFS		<input type="checkbox"/> 14 \$1,160	<input type="checkbox"/> 16 \$1,160	<input type="checkbox"/> 18 \$1,160	<input type="checkbox"/> 20 \$1,160												
		J3PDSHSxxTH		<input type="checkbox"/> 14 \$1,237	<input type="checkbox"/> 16 \$1,237	<input type="checkbox"/> 18 \$1,237	<input type="checkbox"/> 20 \$1,237												
	22.5" (M)	J3PDSHMxxSH		<input type="checkbox"/> 16 \$1,160	<input type="checkbox"/> 18 \$1,160	<input type="checkbox"/> 20 \$1,160													
		J3PDSHMxxFS		<input type="checkbox"/> 16 \$1,160	<input type="checkbox"/> 18 \$1,160	<input type="checkbox"/> 20 \$1,160													
		J3PDSHMxxTH		<input type="checkbox"/> 16 \$1,237	<input type="checkbox"/> 18 \$1,237	<input type="checkbox"/> 20 \$1,237													
	24.0" (T)	J3PDSHTxxSH				<input type="checkbox"/> 18 \$1,160	<input type="checkbox"/> 20 \$1,160												
		J3PDSHTxxFS					<input type="checkbox"/> 18 \$1,160	<input type="checkbox"/> 20 \$1,160											
		J3PDSHTxxTH					<input type="checkbox"/> 18 \$1,237	<input type="checkbox"/> 20 \$1,237											

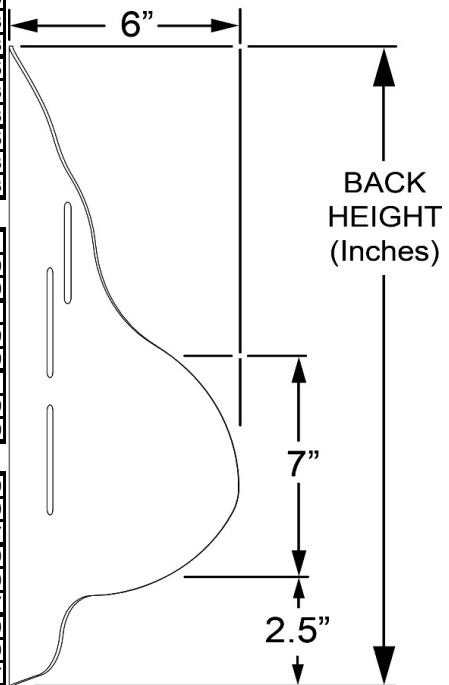

Note: Hardware choices are not offered on every size of J3 Backrest, only options listed above are available.

MOUNTING HARDWARE OPTIONS

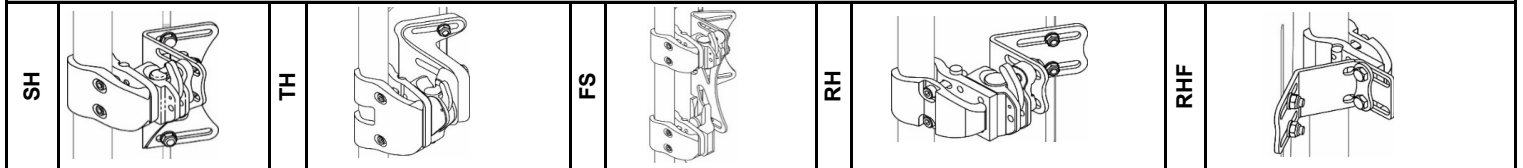

April 2025

Mark For: _____
 Date: _____
 Dealer Acct #: _____
 Dealer: _____
 Dealer Contact: _____
 Dealer Address: _____
 Dealer City: _____ Prov: _____ PC: _____
 Dealer Phone: () _____ Fax: () _____
 Confirmation Email: _____
 Confirm Via: Fax Email

Submitting for: Quote Order
 PO#: _____
ADDITIONAL SHIPPING INFORMATION
 Ship To: _____
 Attention: _____
 Address: _____
 Address: _____
 Ship To City: _____ Prov _____ PC: _____
 Ship To Phone: () _____ Fax: () _____

JAY J3 Posterior Deep Lateral (PDL) Back



BACKREST WIDTH	14"	16"	18"	20"
BACKCANE WIDTHS	14"- 16"	16"- 18"	18"- 20"	20"- 22"
MAX. USER TRUNK WIDTH	11"	13"	15"	17"

Back Height	Lower Thoracic (LT)		X	Y													
		6.5" (S)															
		8.0" (M)															
		9.5" (T)															
	Mid Thoracic (MT)		X	Y													
		12.0" (S)															
		13.5" (M)															
		15.0" (T)															
	Upper Thoracic (UT)		X	Y													
		16.5" (S)	7.5"	5.8"	J3PDLUTSxxSH	<input type="checkbox"/>	14	\$1,057	<input type="checkbox"/>	16	\$1,057	<input type="checkbox"/>	18	\$1,057	<input type="checkbox"/>	20	\$1,057
					J3PDLUTSxxFS	<input type="checkbox"/>	14	\$1,134	<input type="checkbox"/>	16	\$1,134	<input type="checkbox"/>	18	\$1,134	<input type="checkbox"/>	20	\$1,134
					J3PDLUTSxxTH	<input type="checkbox"/>	14	\$1,134	<input type="checkbox"/>	16	\$1,134	<input type="checkbox"/>	18	\$1,134	<input type="checkbox"/>	20	\$1,134
18.0" (M)		8.3"	6.5"	J3PDLUTMxxSH	<input type="checkbox"/>	14	\$1,057	<input type="checkbox"/>	16	\$1,057	<input type="checkbox"/>	18	\$1,057	<input type="checkbox"/>	20	\$1,057	
				J3PDLUTMxxFS	<input type="checkbox"/>	14	\$1,134	<input type="checkbox"/>	16	\$1,134	<input type="checkbox"/>	18	\$1,134	<input type="checkbox"/>	20	\$1,134	
				J3PDLUTMxxTH	<input type="checkbox"/>	14	\$1,134	<input type="checkbox"/>	16	\$1,134	<input type="checkbox"/>	18	\$1,134	<input type="checkbox"/>	20	\$1,134	
19.5" (T)		9.3"	6.8"	J3PDLUTTxxSH	<input type="checkbox"/>	14	\$1,057	<input type="checkbox"/>	16	\$1,057	<input type="checkbox"/>	18	\$1,057	<input type="checkbox"/>	20	\$1,057	
				J3PDLUTTxxFS	<input type="checkbox"/>	14	\$1,134	<input type="checkbox"/>	16	\$1,134	<input type="checkbox"/>	18	\$1,134	<input type="checkbox"/>	20	\$1,134	
				J3PDLUTTxxTH	<input type="checkbox"/>	14	\$1,134	<input type="checkbox"/>	16	\$1,134	<input type="checkbox"/>	18	\$1,134	<input type="checkbox"/>	20	\$1,134	
Shoulder Height (SH)		X	Y														
	21.0" (S)	8"	6"	J3PDLSHSxxSH	<input type="checkbox"/>	14	\$1,087	<input type="checkbox"/>	16	\$1,087	<input type="checkbox"/>	18	\$1,087	<input type="checkbox"/>	20	\$1,087	
				J3PDLSHSxxFS	<input type="checkbox"/>	14	\$1,165	<input type="checkbox"/>	16	\$1,165	<input type="checkbox"/>	18	\$1,165	<input type="checkbox"/>	20	\$1,165	
				J3PDLSHSxxTH	<input type="checkbox"/>	14	\$1,165	<input type="checkbox"/>	16	\$1,165	<input type="checkbox"/>	18	\$1,165	<input type="checkbox"/>	20	\$1,165	
	22.5" (M)	8.8"	6.5"	J3PDLSHMxxSH	<input type="checkbox"/>	16	\$1,087	<input type="checkbox"/>	18	\$1,087	<input type="checkbox"/>	20	\$1,087				
				J3PDLSHMxxFS	<input type="checkbox"/>	16	\$1,165	<input type="checkbox"/>	18	\$1,165	<input type="checkbox"/>	20	\$1,165				
				J3PDLSHMxxTH	<input type="checkbox"/>	16	\$1,165	<input type="checkbox"/>	18	\$1,165	<input type="checkbox"/>	20	\$1,165				
	24.0" (T)	9.5"	7.3"	J3PDLSHTxxSH	<input type="checkbox"/>	18	\$1,087	<input type="checkbox"/>	20	\$1,087							
				J3PDLSHTxxFS	<input type="checkbox"/>	18	\$1,165	<input type="checkbox"/>	20	\$1,165							
				J3PDLSHTxxTH	<input type="checkbox"/>	18	\$1,165	<input type="checkbox"/>	20	\$1,165							

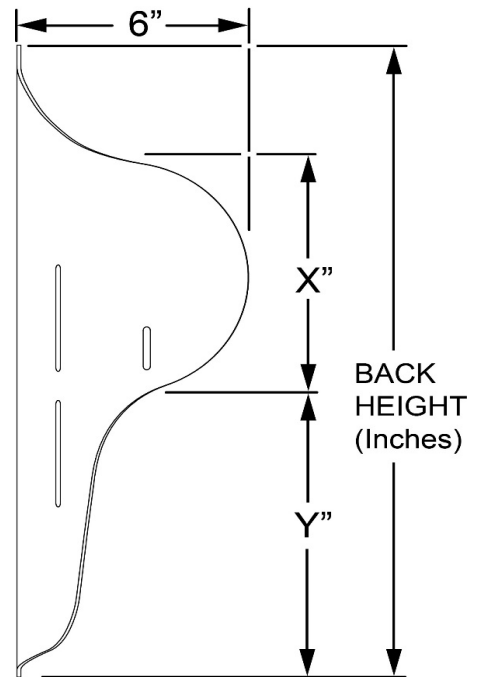

Note: Hardware choices are not offered on every size of J3 Backrest, only options listed above are available.

MOUNTING HARDWARE OPTIONS

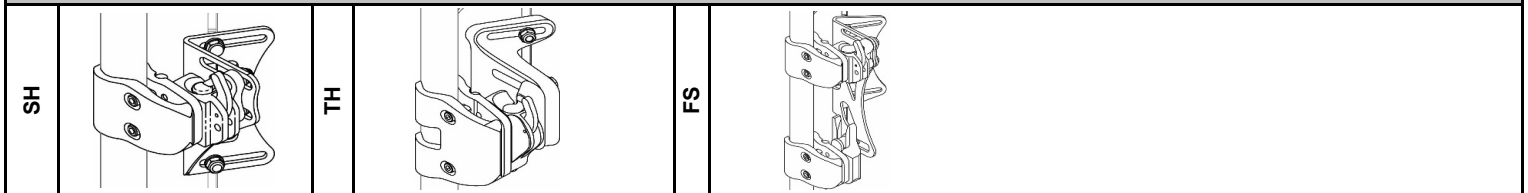

Mark For: _____
 Date: _____
 Dealer Acct #: _____
 Dealer: _____
 Dealer Contact: _____
 Dealer Address: _____
 Dealer City: _____ Prov: _____ PC: _____
 Dealer Phone: () _____ Fax: () _____
 Confirmation Email: _____
 Confirm Via: Fax Email

Submitting for: Quote Order
 PO#: _____
ADDITIONAL SHIPPING INFORMATION
 Ship To: _____
 Attention: _____
 Address: _____
 Address: _____
 Ship To City: _____ Prov _____ PC: _____
 Ship To Phone: () _____ Fax: () _____

JAY J3 Posterior Deep Contour (PDC) Back



BACKREST WIDTH	14"	16"	18"	20"
BACKCANE WIDTHS	14"- 16"	16"- 18"	18"- 20"	20"- 22"
MAX. USER TRUNK WIDTH	11"	13"	15"	17"

		X	Y										
Back Height	Lower Thoracic (LT)												
		6.5" (S)											
		8.0" (M)	5"	.5"	J3PDCLTMxxSH	<input type="checkbox"/> 14	\$775	<input type="checkbox"/> 16	\$775	<input type="checkbox"/> 18	\$775		
					J3PDCLTMxxRH	<input type="checkbox"/> 14	\$855	<input type="checkbox"/> 16	\$855	<input type="checkbox"/> 18	\$855		
	J3PDCLTMxxRHF	<input type="checkbox"/> 14	\$855	<input type="checkbox"/> 16	\$855	<input type="checkbox"/> 18	\$855						
	9.5" (T)	5.2"	.5"	J3PDCLTTxxSH	<input type="checkbox"/> 14	\$775	<input type="checkbox"/> 16	\$775	<input type="checkbox"/> 18	\$775	<input type="checkbox"/> 20	\$775	
				J3PDCLTTxxRH	<input type="checkbox"/> 14	\$855	<input type="checkbox"/> 16	\$855	<input type="checkbox"/> 18	\$855	<input type="checkbox"/> 20	\$855	
				J3PDCLTTxxRHF	<input type="checkbox"/> 14	\$855	<input type="checkbox"/> 16	\$855	<input type="checkbox"/> 18	\$855	<input type="checkbox"/> 20	\$855	
	Mid Thoracic (MT)												
		12.0" (S)	5.5"	.5"	J3PDCMTSxxSH	<input type="checkbox"/> 14	\$925	<input type="checkbox"/> 16	\$925	<input type="checkbox"/> 18	\$925	<input type="checkbox"/> 20	\$925
					J3PDCMTSxxFS	<input type="checkbox"/> 14	\$1,003	<input type="checkbox"/> 16	\$1,003	<input type="checkbox"/> 18	\$1,003	<input type="checkbox"/> 20	\$1,003
					J3PDCMTSxxTH	<input type="checkbox"/> 14	\$1,003	<input type="checkbox"/> 16	\$1,003	<input type="checkbox"/> 18	\$1,003	<input type="checkbox"/> 20	\$1,003
13.5" (M)	6.5"	.5"	J3PDCMTTxxSH	<input type="checkbox"/> 14	\$925	<input type="checkbox"/> 16	\$925	<input type="checkbox"/> 18	\$925	<input type="checkbox"/> 20	\$925		
			J3PDCMTTxxFS	<input type="checkbox"/> 14	\$1,003	<input type="checkbox"/> 16	\$1,003	<input type="checkbox"/> 18	\$1,003	<input type="checkbox"/> 20	\$1,003		
			J3PDCMTTxxTH	<input type="checkbox"/> 14	\$1,003	<input type="checkbox"/> 16	\$1,003	<input type="checkbox"/> 18	\$1,003	<input type="checkbox"/> 20	\$1,003		
Upper Thoracic (UT)													
	16.5" (S)	6.5"	.5"	J3PDCUTMxxSH	<input type="checkbox"/> 14	\$1,068	<input type="checkbox"/> 16	\$1,068	<input type="checkbox"/> 18	\$1,068	<input type="checkbox"/> 20	\$1,068	
				J3PDCUTMxxFS	<input type="checkbox"/> 14	\$1,146	<input type="checkbox"/> 16	\$1,146	<input type="checkbox"/> 18	\$1,146	<input type="checkbox"/> 20	\$1,146	
				J3PDCUTMxxTH	<input type="checkbox"/> 14	\$1,146	<input type="checkbox"/> 16	\$1,146	<input type="checkbox"/> 18	\$1,146	<input type="checkbox"/> 20	\$1,146	
18.0" (M)	6.5"	.5"	J3PDCUTMxxSH	<input type="checkbox"/> 14	\$1,068	<input type="checkbox"/> 16	\$1,068	<input type="checkbox"/> 18	\$1,068	<input type="checkbox"/> 20	\$1,068		
			J3PDCUTMxxFS	<input type="checkbox"/> 14	\$1,146	<input type="checkbox"/> 16	\$1,146	<input type="checkbox"/> 18	\$1,146	<input type="checkbox"/> 20	\$1,146		
			J3PDCUTMxxTH	<input type="checkbox"/> 14	\$1,146	<input type="checkbox"/> 16	\$1,146	<input type="checkbox"/> 18	\$1,146	<input type="checkbox"/> 20	\$1,146		
19.5" (T)	6.5"	.5"	J3PDCUTMxxSH	<input type="checkbox"/> 14	\$1,068	<input type="checkbox"/> 16	\$1,068	<input type="checkbox"/> 18	\$1,068	<input type="checkbox"/> 20	\$1,068		
Shoulder Height (SH)													
	21.0" (S)	6.5"	.5"	J3PDCSHSxxSH	<input type="checkbox"/> 16	\$1,104	<input type="checkbox"/> 18	\$1,104	<input type="checkbox"/> 20	\$1,104			
				J3PDCSHSxxFS	<input type="checkbox"/> 16	\$1,181	<input type="checkbox"/> 18	\$1,181	<input type="checkbox"/> 20	\$1,181			
				J3PDCSHSxxTH	<input type="checkbox"/> 16	\$1,181	<input type="checkbox"/> 18	\$1,181	<input type="checkbox"/> 20	\$1,181			
22.5" (M)	6.5"	.5"	J3PDCSHSxxSH	<input type="checkbox"/> 16	\$1,104	<input type="checkbox"/> 18	\$1,104	<input type="checkbox"/> 20	\$1,104				
24.0" (T)	6.5"	.5"	J3PDCSHSxxSH	<input type="checkbox"/> 16	\$1,104	<input type="checkbox"/> 18	\$1,104	<input type="checkbox"/> 20	\$1,104				

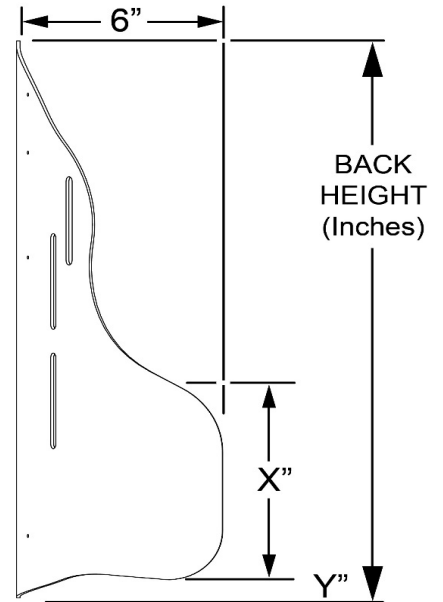

Note: Hardware choices are not offered on every size of J3 Backrest, only options listed above are available.

MOUNTING HARDWARE OPTIONS					
SH		TH		FS	
RH		RHF			

JAY J3 Back Accessories

All JAY J3 Back accessories are optional. All accessories will be factory mounted as much as possible to insure proper shipping (if selected below).

SHIPPING INSTRUCTIONS

<input type="checkbox"/>	N/A	Ship Back on Chair (Chair to be ordered separately)	N/C	<input type="checkbox"/>	N/A	Ship accessories mounted on back	N/C
--------------------------	-----	---	-----	--------------------------	-----	----------------------------------	-----

Headrests

Use this section for selecting headrest. Head supports are not available on LT Back Shells

STEP 1

Select your HEADREST POST

Please select one box from the below **Headrest Mount & Bracket** choices.

	Option #	Definition	Price		Option #	Definition	Price
<input type="checkbox"/>	J3HEDX	Axys Mount & Bracket	\$193.00	<input type="checkbox"/>	J3HEDO	ONYX Mount & Bracket	\$160.00
<input type="checkbox"/>	J3HEDL	LINX Mount & Bracket	\$149.00	<input type="checkbox"/>	J3HEDC	Cobra Mount & Bracket	\$364.00
<input type="checkbox"/>	J3HEDL2	LINX ² Mount & Bracket	\$354.00	<input type="checkbox"/>	J3HEDF	Cobra Flip Back Mount and Bracket	\$428.00



STEP 2

Select your HEADREST PAD

Please select one box from the below **Headrest Pad** choices.

<input type="checkbox"/>	14	J3PLSH14 - 14" Plush Pad	\$210.00	<input type="checkbox"/>	AAPS	J3AAPS - Adjust-A-Plush Standard (Lg)	\$358.00
<input type="checkbox"/>	10	J3PLSH10 - 10" Plush Pad	\$210.00	<input type="checkbox"/>	AAPM	J3AAPM - Adjust-A-Plush Medium	\$358.00
<input type="checkbox"/>	8	J3PLSH8 - 8" Plush Pad	\$210.00	<input type="checkbox"/>	AAPN	J3AAPN - Adjust-A-Plush Narrow (Sm)	\$358.00
<input type="checkbox"/>	HUPL	J3HUPL - HeadsUp Lrg: 5.3" Lng Arms	\$358.00	<input type="checkbox"/>	CL	J3CRDLLG - Lrg Contour Cradle Pad	\$407.00
<input type="checkbox"/>	HUPM	J3HUPM - HeadsUp Med: 4.1" Sht Arms	\$358.00	<input type="checkbox"/>	CM	J3CRDLMD - Med Contour Cradle Pad	\$407.00
<input type="checkbox"/>	HUPS	J3HUPS - HeadsUp Sml: 3.5" Sht Arms	\$358.00	<input type="checkbox"/>	PL	J3CPLULG - Large C-Plush Pad	\$407.00
				<input type="checkbox"/>	PM	J3CPLUMD - Medium C-Plush Pad	\$407.00

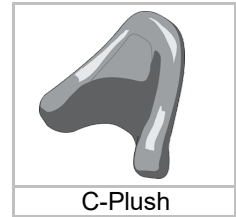
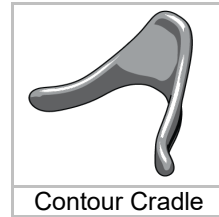
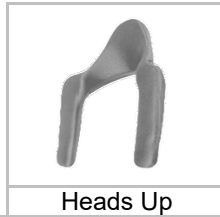
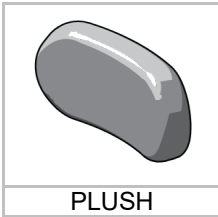

STEP 1 - Headrest Post		+	STEP 2 - Headrest Pad #		=	Completed JAY J3 Headrest #
Example = J3HEDX			Example = 14			Example = J3HEDX14

Universal Mounting Plate

<input type="checkbox"/>	J3UHM	Universal Headrest Mounting Plate Only	\$68.00
--------------------------	-------	--	---------

Lateral Supports

Use this section for selecting laterals and hardware. Lateral supports are not available on Lower Thoracic Back Shells

Lateral Thoracic Support (Fixed)

Includes fixed mounting hardware. Lateral pads use 3DX covers with 1/2" Sunmate foam in the core

<input type="checkbox"/>	J3LAT4X4FX	LATERAL 4" Depth X 4" Height FIXED	\$335.00	<input type="checkbox"/>	J3LAT6X4FX	LATERAL 6" Depth X 4" Height FIXED	\$335.00
<input type="checkbox"/>	J3LAT4X5FX	LATERAL 4" Depth X 5" Height FIXED	\$335.00	<input type="checkbox"/>	J3LAT6X5FX	LATERAL 6" Depth X 5" Height FIXED	\$335.00
<input type="checkbox"/>	J3LAT4X6FX	LATERAL 4" Depth X 6" Height FIXED	\$335.00	<input type="checkbox"/>	J3LAT6X6FX	LATERAL 6" Depth X 6" Height FIXED	\$335.00

Swing-Away Lateral Thoracic Support

Includes: Swing-away mounting hardware, left and right lateral are independent. Different types and sizes can be selected for each side.

Left Side				Right Side			
<input type="checkbox"/>	JLATSA44L	LAT 4X4 W/ S/A MOUNTS - LH	\$334.00	<input type="checkbox"/>	JLATSA44R	LAT 4X4 W/ S/A MOUNTS - RH	\$334.00
	JLAT4X4	Lateral 4" Depth X 4" Height	\$215.00		JLAT4X4	Lateral 4" Depth X 4" Height	\$215.00
	JSAMNTL	Lateral Swing Away Mount - Left	\$119.00		JSAMNTR	Lateral Swing Away Mount - Right	\$119.00
<input type="checkbox"/>	JLATSA45L	LAT 4X5 W/ S/A MOUNTS - LH	\$334.00	<input type="checkbox"/>	JLATSA45R	LAT 4X5 W/ S/A MOUNTS - RH	\$334.00
	JLAT4X5	LATERAL 4" Depth X 5" Height	\$215.00		JLAT4X5	Lateral 4" Depth X 5" Height	\$215.00
	JSAMNTL	Lateral Swing Away Mount - Left	\$119.00		JSAMNTR	Lateral Swing Away Mount - Right	\$119.00
<input type="checkbox"/>	JLATSA46L	LAT 4X6 W/ S/A MOUNTS - LH	\$334.00	<input type="checkbox"/>	JLATSA46R	LAT 4X6 W/ S/A MOUNTS - RH	\$334.00
	JLAT4X6	LATERAL 4" Depth X 6" Height	\$215.00		JLAT4X6	Lateral 4" Depth X 6" Height	\$215.00
	JSAMNTL	Lateral Swing Away Mount - Left	\$119.00		JSAMNTR	Lateral Swing Away Mount - Right	\$119.00
<input type="checkbox"/>	JLATSA64L	LAT 6X4 W/ S/A MOUNTS - LH	\$334.00	<input type="checkbox"/>	JLATSA64R	LAT 6X4 W/ S/A MOUNTS - RH	\$334.00
	JLAT6X4	LATERAL 6" Depth X 4" Height	\$215.00		JLAT6X4	Lateral 6" Depth X 4" Height	\$215.00
	JSAMNTL	Lateral Swing Away Mount - Left	\$119.00		JSAMNTR	Lateral Swing Away Mount - Right	\$119.00
<input type="checkbox"/>	JLATSA65L	LAT 6X5 W/ S/A MOUNTS - LH	\$334.00	<input type="checkbox"/>	JLATSA65R	LAT 6X5 W/ S/A MOUNTS - RH	\$334.00
	JLAT6X5	LATERAL 6" Depth X 5" Height	\$215.00		JLAT6X5	Lateral 6" Depth X 5" Height	\$215.00
	JSAMNTL	Lateral Swing Away Mount - Left	\$119.00		JSAMNTR	Lateral Swing Away Mount - Right	\$119.00
<input type="checkbox"/>	JLATSA66L	LAT 6X6 W/ S/A MOUNTS - LH	\$334.00	<input type="checkbox"/>	JLATSA66R	LAT 6X6 W/ S/A MOUNTS - RH	\$334.00
	JLAT6X6	LATERAL 6" Depth X 6" Height	\$215.00		JLAT6X6	Lateral 6" Depth X 6" Height	\$215.00
	JSAMNTL	Lateral Swing Away Mount - Left	\$119.00		JSAMNTR	Lateral Swing Away Mount - Right	\$119.00

Rotational Swing-Away Lateral Thoracic Support

Includes: Rotational swing-away mounting hardware, left and right lateral are independent. Different types and sizes can be selected for each side.

Left Side				Right Side			
<input type="checkbox"/>	JLATRSA44L	LAT 4X4 W/ S/A MOUNTS - LH	\$367.00	<input type="checkbox"/>	JLATRSA44R	LAT 4X4 W/ S/A MOUNTS - RH	\$367.00
	JLAT4X4	Lateral 4" Depth X 4" Height	\$215.00		JLAT4X4	Lateral 4" Depth X 4" Height	\$215.00
	JRSAMNTL	Lateral Swing Away Mount - Left	\$152.00		JRSAMNTR	Lateral Swing Away Mount - Right	\$152.00
<input type="checkbox"/>	JLATRSA45L	LAT 4X5 W/ S/A MOUNTS - LH	\$367.00	<input type="checkbox"/>	JLATRSA45R	LAT 4X5 W/ S/A MOUNTS - RH	\$367.00
	JLAT4X5	LATERAL 4" Depth X 5" Height	\$215.00		JLAT4X5	Lateral 4" Depth X 5" Height	\$215.00
	JRSAMNTL	Lateral Swing Away Mount - Left	\$152.00		JRSAMNTR	Lateral Swing Away Mount - Right	\$152.00
<input type="checkbox"/>	JLATRSA46L	LAT 4X6 W/ S/A MOUNTS - LH	\$367.00	<input type="checkbox"/>	JLATRSA46R	LAT 4X6 W/ S/A MOUNTS - RH	\$367.00
	JLAT4X6	LATERAL 4" Depth X 6" Height	\$215.00		JLAT4X6	Lateral 4" Depth X 6" Height	\$215.00
	JRSAMNTL	Lateral Swing Away Mount - Left	\$152.00		JRSAMNTR	Lateral Swing Away Mount - Right	\$152.00
<input type="checkbox"/>	JLATRSA64L	LAT 6X4 W/ S/A MOUNTS - LH	\$367.00	<input type="checkbox"/>	JLATRSA64R	LAT 6X4 W/ S/A MOUNTS - RH	\$367.00
	JLAT6X4	LATERAL 6" Depth X 4" Height	\$215.00		JLAT6X4	Lateral 6" Depth X 4" Height	\$215.00
	JRSAMNTL	Lateral Swing Away Mount - Left	\$152.00		JRSAMNTR	Lateral Swing Away Mount - Right	\$152.00
<input type="checkbox"/>	JLATRSA65L	LAT 6X5 W/ S/A MOUNTS - LH	\$367.00	<input type="checkbox"/>	JLATRSA65R	LAT 6X5 W/ S/A MOUNTS - RH	\$367.00
	JLAT6X5	LATERAL 6" Depth X 5" Height	\$215.00		JLAT6X5	Lateral 6" Depth X 5" Height	\$215.00
	JRSAMNTL	Lateral Swing Away Mount - Left	\$152.00		JRSAMNTR	Lateral Swing Away Mount - Right	\$152.00
<input type="checkbox"/>	JLATRSA66L	LAT 6X6 W/ S/A MOUNTS - LH	\$367.00	<input type="checkbox"/>	JLATRSA66R	LAT 6X6 W/ S/A MOUNTS - RH	\$367.00
	JLAT6X6	LATERAL 6" Depth X 6" Height	\$215.00		JLAT6X6	Lateral 6" Depth X 6" Height	\$215.00
	JRSAMNTL	Lateral Swing Away Mount - Left	\$152.00		JRSAMNTR	Lateral Swing Away Mount - Right	\$152.00

Spine-Align Positioning Components

J3 Back LT models come standard with a Small Lumbar, MT,UT and SH models come standard with a small and large lumbar.

SPINE-ALIGN MINI FIT KIT 1

Includes: 3 wedges, 2 lateral shims, and 2 posterior/lateral pelvic positioning pads.

<input type="checkbox"/>	J3SPNK112	SPINE-ALIGN MINI FIT KIT 1 (12")	\$146.00
<input type="checkbox"/>	J3SPNK114	SPINE-ALIGN MINI FIT KIT 1 (14")	\$146.00
<input type="checkbox"/>	J3SPNK116	SPINE-ALIGN MINI FIT KIT 1 (16")	\$146.00
<input type="checkbox"/>	J3SPNK118	SPINE-ALIGN MINI FIT KIT 1 (18")	\$146.00
<input type="checkbox"/>	J3SPNK120	SPINE-ALIGN MINI FIT KIT 1 (20")	\$146.00

LARGE LUMBAR PADS (Back Width) (W" x H" x D")

<input type="checkbox"/>	J3SPNLL12	LG LUMBAR (12") (3.5" x 7" x 1.6")	\$61.00
<input type="checkbox"/>	J3SPNLL14	LG LUMBAR (14") (3.5" x 7" x 1.6")	\$61.00
<input type="checkbox"/>	J3SPNLL16	LG LUMBAR (16") (5.5" x 7" x 1.6")	\$61.00
<input type="checkbox"/>	J3SPNLL18	LG LUMBAR (18") (7.5" x 7" x 1.6")	\$61.00
<input type="checkbox"/>	J3SPNLL20	LG LUMBAR (20") (9.5" x 7" x 1.6")	\$61.00

WEDGES (Back Width) (W" x H" x D")

<input type="checkbox"/>	J3SPNWE12	WEDGES (12") (3.5" x 6.5" x 1.6")	\$47.00
<input type="checkbox"/>	J3SPNWE14	WEDGES (14") (3.5" x 6.5" x 1.6")	\$47.00
<input type="checkbox"/>	J3SPNWE16	WEDGES (16") (5.5" x 6.5" x 1.6")	\$48.00
<input type="checkbox"/>	J3SPNWE18	WEDGES (18") (7.5" x 6.5" x 1.6")	\$48.00
<input type="checkbox"/>	J3SPNWE20	WEDGES (20") (9.5" x 6.5" x 1.6")	\$48.00

SPINE-ALIGN MINI FIT KIT 2

Includes: 5 wedges, 2 lat shims, 2 post/lat pelvic, 1 lg lumbar, 1 flat shim, and 1 curved









<input type="checkbox"/>	J3SPNK212	SPINE-ALIGN MINI FIT KIT 2 (12")	\$216.00
<input type="checkbox"/>	J3SPNK214	SPINE-ALIGN MINI FIT KIT 2 (14")	\$216.00
<input type="checkbox"/>	J3SPNK216	SPINE-ALIGN MINI FIT KIT 2 (16")	\$216.00
<input type="checkbox"/>	J3SPNK218	SPINE-ALIGN MINI FIT KIT 2 (18")	\$216.00
<input type="checkbox"/>	J3SPNK220	SPINE-ALIGN MINI FIT KIT 2 (20")	\$216.00

SMALL LUMBAR PADS (Back Width) (W" x H" x D")

<input type="checkbox"/>	J3SPNSL12	SML LUMBAR (12") (1.8" x 3.2" x 0.8")	\$63.00
<input type="checkbox"/>	J3SPNSL14	SML LUMBAR (14") (3.5" x 4.3" x 1")	\$63.00
<input type="checkbox"/>	J3SPNSL16	SML LUMBAR (16") (5.5" x 4.3" x 1")	\$63.00
<input type="checkbox"/>	J3SPNSL18	SML LUMBAR (18") (7.5" x 4.3" x 1")	\$63.00
<input type="checkbox"/>	J3SPNSL20	SML LUMBAR (20") (9.5" x 4.3" x 1")	\$63.00

OTHER INDIVIDUAL SPINE-ALIGN COMPONENTS

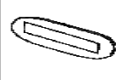
<input type="checkbox"/>	J3SPNCR	Curved Shim	\$37.00
<input type="checkbox"/>	J3SPNBS	Small Bean Bag	\$42.00
<input type="checkbox"/>	J3SPNFL	Flat Shim	\$37.00
<input type="checkbox"/>	J3SPNBL	Large Bean Bag	\$42.00
<input type="checkbox"/>	J3SPNLS	Lateral Shim	\$67.00
<input type="checkbox"/>	J3SPNLP	Posterior/Lateral Pelvic	\$67.00

									
	Sm Lumbar	Lg Lumbar	Wedge	Curved Slim	Flat	Lateral Slim	Sm Bean Bag	Lg Bean Bag	Post/Lat Pelvic
W	1.8" - 9.5"	3.5" - 9.5"	3.5" - 9.5"	10"	10"	2.4"	6"	10"	5.3"
H	3.2" - 4.3"	7"	6.5"	4"	4"	4.3"	4.5"	3.2"	3.6"
D	0.8" - 1"	1.6"	1.6"	0.5"	0.3"	0.5"	0.75"	0.75"	0.75"

Chest Straps, Harnesses and Brackets

Use this section for selecting harnesses. Harnesses are not available on Lower Thoracic Back Shells

CHEST STRAPS & HARNESSES *(Includes strap guides & mounting hardware)*

<input type="checkbox"/>	J3HRNCOS	Center Opening w/ Buckle (Sml)	\$238.00	<input type="checkbox"/>	J3HRNTDS	Contoured-Dynamic Pull Down (Sml)	\$238.00
<input type="checkbox"/>	J3HRNCOM	Center Opening w/ Buckle (Med)	\$238.00	<input type="checkbox"/>	J3HRNTDM	Contoured-Dynamic Pull Down (Med)	\$238.00
<input type="checkbox"/>	J3HRNCOL	Center Opening w/ Buckle (Lrg)	\$238.00	<input type="checkbox"/>	J3HRNTDL	Contoured-Dynamic Pull Down (Lrg)	\$238.00
<input type="checkbox"/>	J3HRNCOX	Center Opening w/ Buckle (X-Lrg)	\$238.00	<input type="checkbox"/>	J3HRNTDX	Contoured-Dynamic Pull Down (X-Lrg)	\$238.00
<input type="checkbox"/>	J3HRNCDS	Classic-Dynamic Pull Down (Sml)	\$238.00	<input type="checkbox"/>	J3HRNTSS	Contoured-Structured Pull Down (Sml)	\$238.00
<input type="checkbox"/>	J3HRNCDM	Classic-Dynamic Pull Down (Med)	\$238.00	<input type="checkbox"/>	J3HRNTSM	Contoured-Structured Pull Down (Med)	\$238.00
<input type="checkbox"/>	J3HRNCDL	Classic-Dynamic Pull Down (Lrg)	\$238.00	<input type="checkbox"/>	J3HRNTSL	Contoured-Structured Pull Down (Lrg)	\$238.00
<input type="checkbox"/>	J3HRNCDX	Classic-Dynamic Pull Down (X-Lrg)	\$238.00	<input type="checkbox"/>	J3HRNTSX	Contoured-Structured Pull Down (X-Lrg)	\$238.00
<input type="checkbox"/>	J3HRNCSS	Classic-Structured Pull Down (Sml)	\$238.00	<input type="checkbox"/>	J3HRNPSS	Padded Anterior Trunk Straps (Sml)	\$238.00
<input type="checkbox"/>	J3HRNCSM	Classic-Structured Pull Down (Med)	\$238.00	<input type="checkbox"/>	J3HRNPMS	Padded Anterior Trunk Straps (Med)	\$238.00
<input type="checkbox"/>	J3HRNCSL	Classic-Structured Pull Down (Lrg)	\$238.00	<input type="checkbox"/>	J3HRNPXL	Padded Anterior Trunk Straps (Lrg)	\$238.00
<input type="checkbox"/>	J3HRNC SX	Classic-Structured Pull Down (X-Lrg)	\$238.00	<input type="checkbox"/>	J3HRNPXS	Padded Anterior Trunk Straps (X-Lrg)	\$238.00

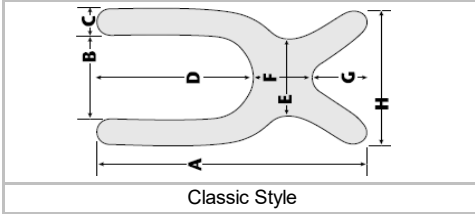

	A	B	C	D	E	F	G	H
S	15"	4.5"	2"	9"	4"	4"	2"	8.5"
M	19"	5.5"	2"	11"	5"	5"	3"	9.5"
L	22.5"	6.5"	2"	13"	6"	6"	3.5"	10.5"
XL	25.5"	6.5"	2.5"	14"	7"	7"	4.5"	11.5"

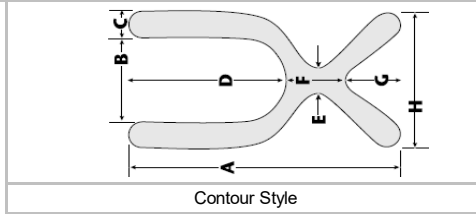

	A	B	C	D	E	F	G	H
S	15"	4.5"	2"	9"	1"	4"	2"	8.5"
M	18.5"	5.5"	2"	11"	1"	5"	2.5"	9.5"
L	22.5"	6.5"	2"	13"	1.5"	6"	3.5"	10.5"
XL	25.5"	6.5"	2.5"	14"	1.5"	7"	4.5"	11.5"

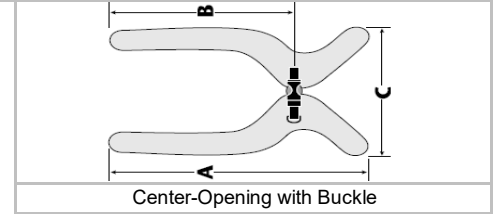

	A	B	C
S	12.3"	9"	6.5"
M	14.3"	11"	9.8"
L	15.5"	11.5"	9.8"
XL	17.5"	12.8"	10"

GUIDE BRACKETS & HARDWARE ONLY

<input type="checkbox"/>	J3GPSG	Shoulder Strap Guides	\$52.00	<input type="checkbox"/>	J3HHP	Hardware Pack Only	\$27.00
--------------------------	--------	-----------------------	---------	--------------------------	-------	--------------------	---------

VANITY FLAP

<input type="checkbox"/>	117096	12" to 14" Wide	\$88.00	<input type="checkbox"/>	117099	18" to 20" Wide	\$88.00
<input type="checkbox"/>	117097	14" to 16" Wide	\$88.00	<input type="checkbox"/>	117100	20" to 22" Wide	\$88.00
<input type="checkbox"/>	117098	16" to 18" Wide	\$88.00				

INNER COVER

To order a optional inner cover enter a additional line item by adding "IC" to the front of your desired J3 back part number and remove your hardware suffix.

<input type="checkbox"/>	Add "IC"	Inner Cover	\$159.00
--------------------------	----------	-------------	----------

JAY YOUR WAY MODIFICATIONS

To order sizes offered via JAY Your Way add a "M" to the front of the part number and follow the prompts.

For additional modifications visit www.sunrisemedical.ca.

PAINTED BACK SHELL

SBC Painted Back Shell NC

Color: Match Quickie or Zippie Frame Color

Note: Backshells can be painted any Quickie or Zippie Frame color at no charge please specify the desired color in the NOTES box below. For a full listing of frame colors available please visit www.sunrisemedical.com

EMBROIDERY

EMBROIDERY Embroidery (32 Character Max) NC

Location: Front

Font: Block Script

Embroidery Text:
 Embroidery Color:

SPINAL FLUID PAD

<input type="checkbox"/>	SFPS	Small Spinal Fluid Pad (16" Height)	\$61.00
<input type="checkbox"/>	SFPM	Medium Spinal Fluid Pad (18" Height)	\$61.00
<input type="checkbox"/>	SFPT	Tall Spinal Fluid Pad (20" Height)	\$61.00
<input type="checkbox"/>	SFPXT	Extra Tall Spinal Fluid Pad (23" Height)	\$61.00

VISCO FOAM INSERT

<input type="checkbox"/>	VF	Visco Foam Insert	\$61.00
<input type="checkbox"/>	VFWSR	Visco Foam Insert with Spinal Relief	\$61.00

Note: 2 Layers of 1" Yellow Visco foam is utilized as standard. Different colors of Visco foam can be utilized just list desired color in notes below.

Don't see the option you want? NO PROBLEM! Write your request below and we can evaluate it and provide a quote.

Notes:



Sunrise Medical Canada Inc.

1000 Creditstone Road, Unit 2 · Concord, ON L4K 4P8