



VOYAGE POSTURAL COMPONENTS INSTALLATION AND ADJUSTMENT GUIDE



Please read these instructions carefully before beginning the installation. Failure to understand and follow installation instructions may result in injury to installer an/or end user and may void the warranty.
If you have any questions call Sunrise Medical Technical support at 800.333.4000

CONTENTS:

1	Voyage Postural Components Overview.....	1
2	Shoe Holder.....	2
3	Lateral Thigh Support.....	3
4	Lateral Hip Support.....	4
5	Medial Support (not shown).....	5
6	Fixed Angle Adjustable Lateral Trunk Support.....	6
7	Swing-away Lateral Trunk Support.....	7
8	Headrest Support.....	8
9	Pelvic Positioning Belt.....	9
10	Comfort Fit ATS.....	10
	(Anterior Trunk Support) (Li'l Kiddos)	

TOOLS NEEDED

- 4mm Hex key
- 3/16" Hex key
- 1/8" Hex key
- 10mm open-end combination wrench

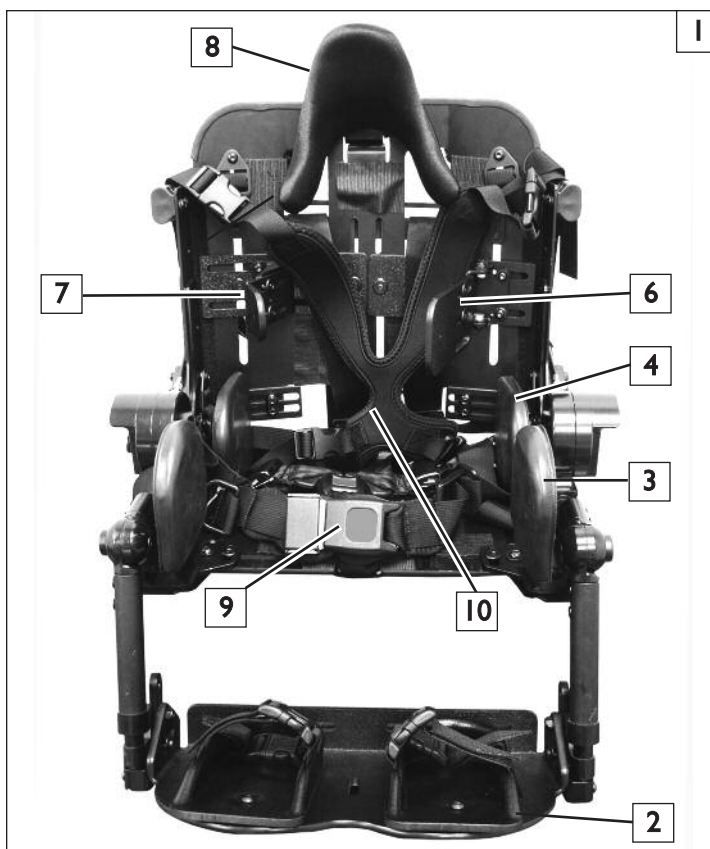

POSITIONING/GROWTH ADJUSTMENTS

WARNING

If a change in adjustment is necessary for growth or positioning, a healthcare professional must be consulted before any changes are made. These adjustments are very important to the orthopedic and neurological needs of the child. Care should be taken to make sure the changes are physiologically and medically appropriate. Sunrise Medical suggests that any positioning or growth adjustments be made by the service provider under the direction of a healthcare professional. Do not allow any adjustments while the child is seated in the mobility device.

DEALER/TECHNICIAN WARNING

WARNING

Attention dealers and qualified technicians, do not operate or service this device without first reading the owners manual. If you do not understand the instructions and warnings in the owners manual, please contact Technical Support at the number above, before operating and/or servicing the device. Failure to do so may result in damage and/or injury.

INSTALLATION AND ADJUSTMENT OF THE SHOE HOLDER

The left and right shoe holders can mount to the footrest plate by using 2x 10-24 T-nuts, 2x washers and 2x 10-24x1/2 screws per side.

I. Mount the shoe holder 2 3 4

- a. Make sure that height and angle adjustment of the footplate (A) is optimal before proceeding to the next steps.
- b. Place the shoe holder on top of the footplate, it should align with the slots (B).
- b. Insert the T-nuts through the top of the shoe holder, and thread the button head screws (D) and Washers (E) through the bottom of the footplate as shown in (figure 4).
- c. Using a 1/8" hex key, snug but do not tighten the screws so that the feet can be placed in the best location for support and posture.

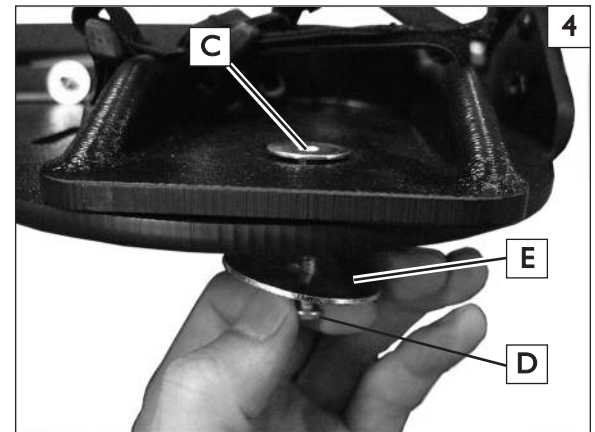
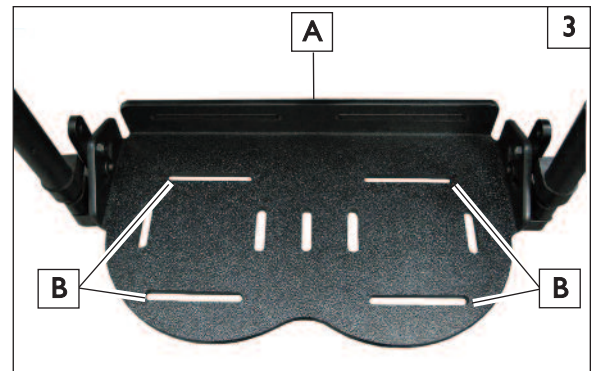
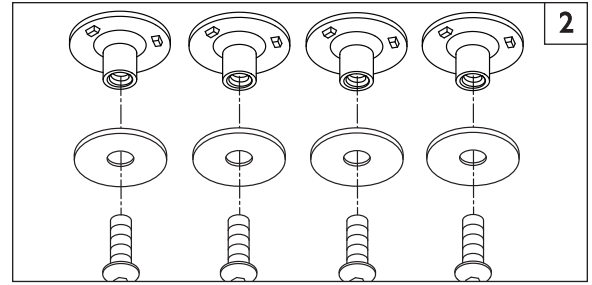

2. Adjust the shoe holder 5

- a. The shoe holder can slide left or right in the slot (Figure 5).
- b. Once the correct placement of the shoe holder is determined, use the 1/8" hex key to tighten the 10-24x 1/2 screws.
- c. If necessary, repeat the steps for the other side.

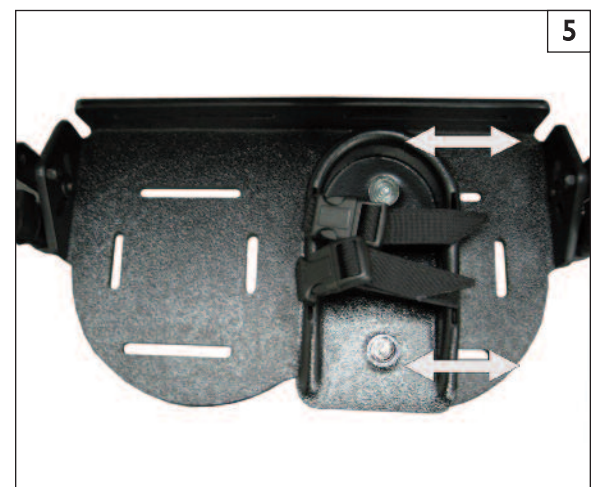

INSTALLATION AND ADJUSTMENT OF THE LATERAL THIGH SUPPORT

The left and right thigh support pads and brackets can be mounted to the asymmetrical leg plates, using 2x T-nuts, 2x washer, and 2x M6x1x12 screws per side.

1. Prepare leg plates for installation 6 7

- a. It may be necessary to loosen the screws (A) under the legplate (B) so it can slide forward. This will allow access the outer slots, so that the T-nuts (C) can be inserted from the bottom as shown.
- b. Hold the T-nuts in the correct position and slide the leg plate back until the T-nuts are held securely. This will make it easier to install the thigh pad brackets.

NOTE: (Figure 7) shows t-nuts locations for the widest position.

2. Attach the lateral thigh support 8 9 10

- a. The lateral thigh support bracket and pad (D) can be installed in several width and depth configurations. 3 examples are shown in (figures 8, 9 & 10 (Wide, Medium Wide, and Medium).
- b. Using a 4mm hex key, attach the thigh support bracket using 2x button head screws, 2x washers, and 2x T-nuts. Do not tighten the hardware until correct adjustment has been made.
- c. The bracket and pad can be rotated slightly to support most leg angles.
- d. Using the 4mm hex key, tighten the screws.
- e. If necessary, repeat the steps for the other side.

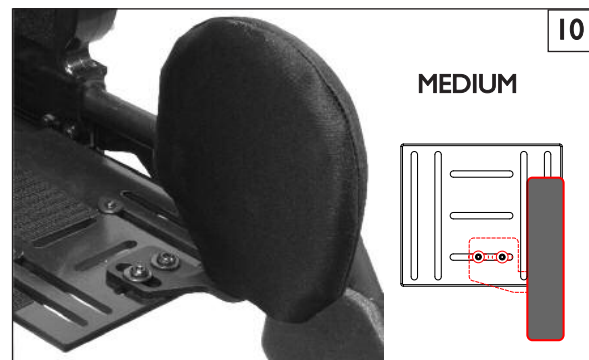
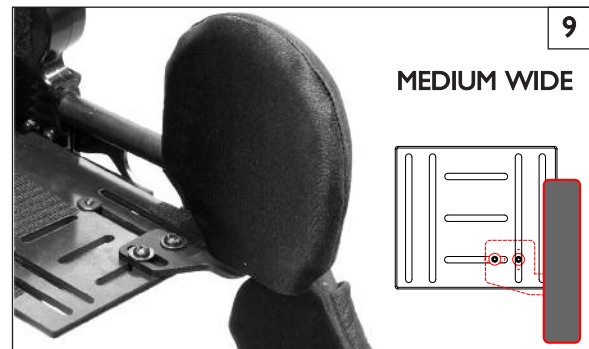
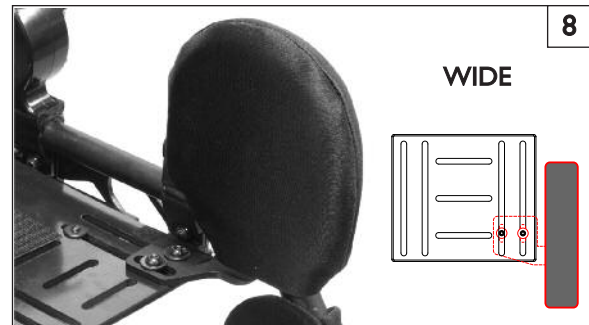
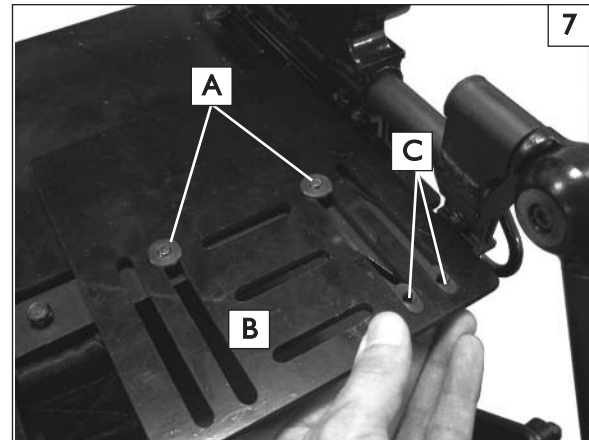
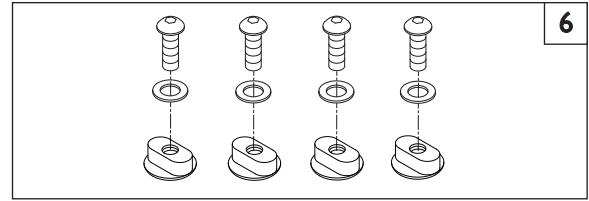

INSTALLATION AND ADJUSTMENT OF THE LATERAL HIP SUPPORT

The left and right hip supports can be mounted to the backshell using 2x T-nut, 2x washers, and 2x M6x1x12 bolts per side.

1. Attachment location 11 12

- a. The hip support mounting points can be found behind the back support padding on the seating shell in locations shown (A)

2. Attaching the hip support pad/bracket 12 13

- a. Mount the lateral hip support (B) to the backshell by placing the lateral bracket on the inside of the backshell, and insert the t-nut thru the front of the backrest, and lateral bracket.
- b. Thread the M6 screws into the t-nuts (C).
- c. Using a 4mm hex key, snug the screws.

3. Hip support pad adjustment 13

- a. You can move the pad and bracket horizontally in and out for optimum fit.
- b. After adjusting to proper fit, use the 4mm Hex Key and tighten the screws on each side
- d. If necessary repeat the steps for the other side.

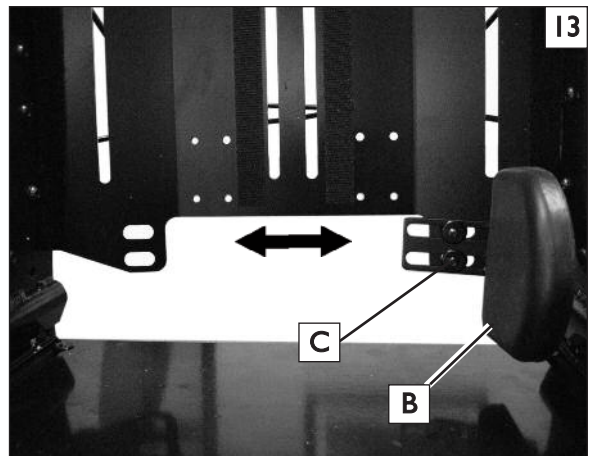
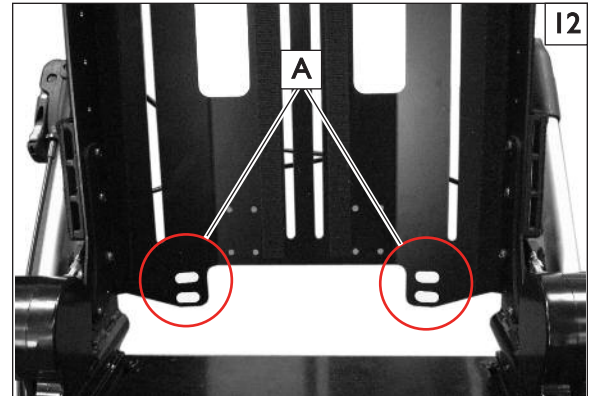
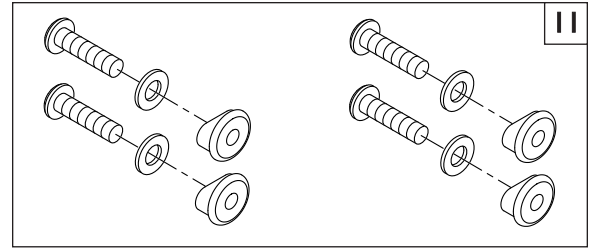

INSTALLATION AND ADJUSTMENT OF THE MEDIAL SUPPORT

The Medial support can be mounted to the seatpan using 1x M6x1x16 bolt, and 1x washer.

1. Remove the Lower Transit Strap 15

- a. The medial support mounting point can be found under the front of the seat pan in location shown (A).
- b. Using the 4mm hex key, remove the screw holding the lower transit strap, and discard it. This is where the medial support bracket will attach.

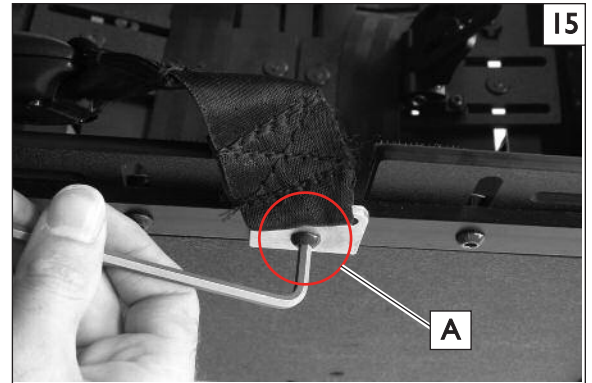
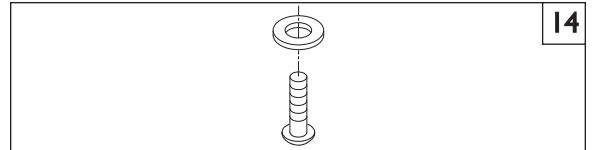
2. Assembly of parts before attaching the bracket 16

- a. Assemble the longer screw (B), washer (C), medial bracket (D), and seat belt (E) as shown in (figure 16).

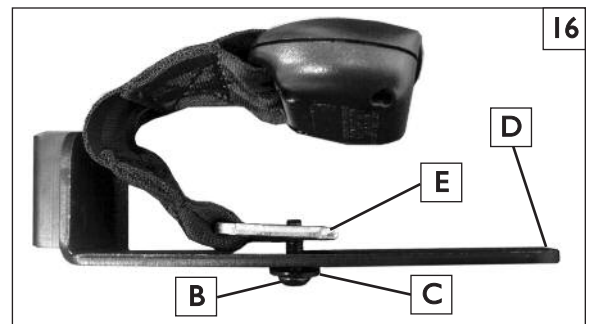
2. Attach and adjust the medial support pad/bracket 17 18

- a. Using the 4mm hex key, mount the medial support bracket at the same location as the belt attachment point (A) on the seat pan.
- b. Make sure the bracket (D) is straight, and using the 4mm hex key, tighten the screw (B) to a torque of 40-45 in-lbs.
- c. Insert the hip abductor/Medial pad post (F) into the receiver (G).

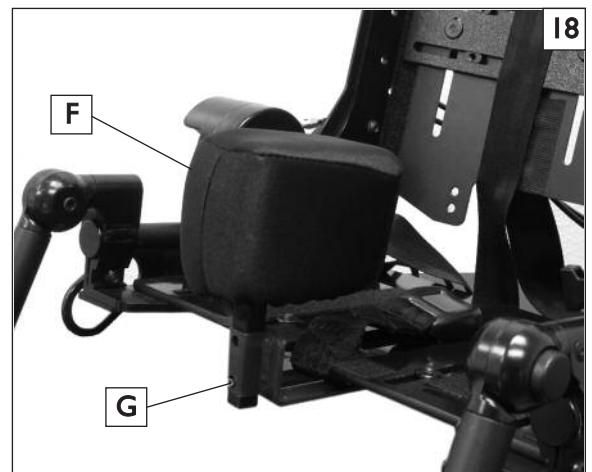
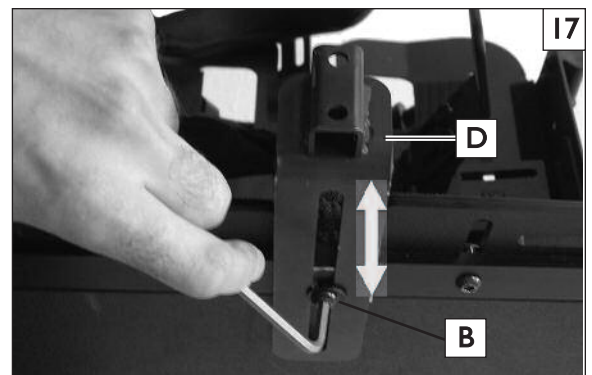

INSTALLATION AND ADJUSTMENT OF THE FIXED ANGLE ADJUSTABLE LATERAL TRUNK SUPPORT

The Fixed Angle Adjustable Lateral Trunk Support can be mounted to the lateral back plates using 2x T-nuts, 2x washers, and 2x M6x1x12 bolts per side.

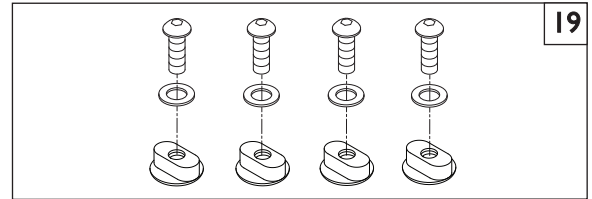
**1. Location and Attachment** 19 20

- a. Using a 4mm hex key from the rear of the seating shell, loosen the screws(A) for the lateral back mount plate (B).
- b. Slide the Mount plate to a position that allows some open space in the horizontal slots, so that you can attach the fixed trunk supports.

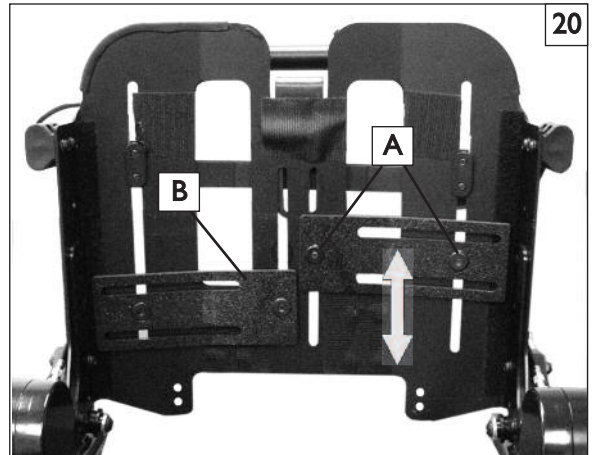
**2. Attaching and adjusting the Lateral Trunk Support** 21

- a. Using the 4mm hex key, mount the Lateral Trunk Support bracket holding the T-nuts in place from the rear of the backshell, thread the M6 screws (C) thru the Lateral bracket and into the T-nuts.
- b. Adjust the bracket and pad mount(D) to its optimum support position, and tighten the hardware.
- c. Mount the pad to the pad mount(D).
- d. Repeat the steps on both sides.

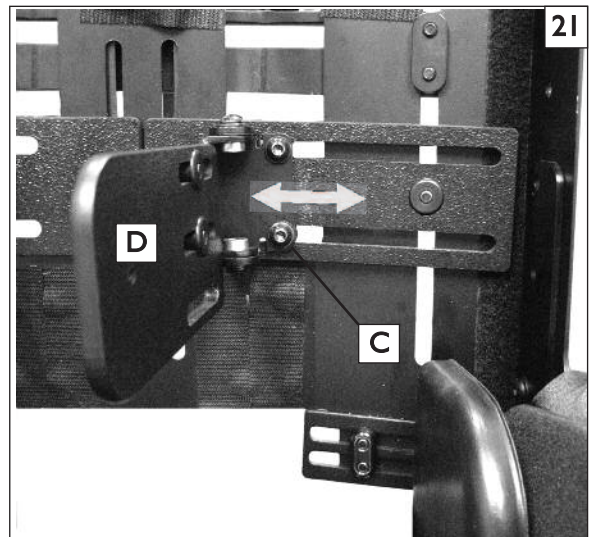

INSTALLATION AND ADJUSTMENT OF THE SWING-AWAY LATERAL TRUNK SUPPORT

The Swing-away Lateral Trunk Support can be mounted to the lateral back plates using 2x T-nuts, 2x washers, and 2x M6x1x12 bolts per side.

1. Location and Attachment 22 23

- a. Using a 4mm hex key from the rear of the seating shell, loosen the screws(A) for the lateral back mount plate (B).
- b. Slide the Mount plate to a position that allows some open space in the horizontal slots, so that you can attach the swing-away trunk supports.

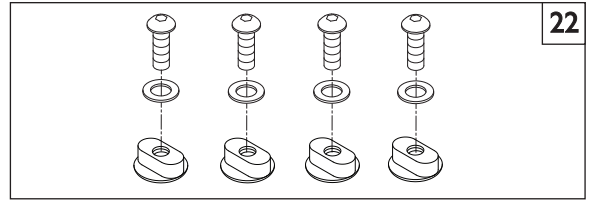

2. Attaching and adjusting the Lateral Trunk Support 24

- a. Using the 4mm hex key, mount the Lateral Trunk Support bracket holding the T-nuts in place from the rear of the backshell, thread the M6 screws (C) thru the Lateral bracket and into the T-nuts.
- b. Adjust the bracket and pad mount(D) to it's optimum support position, and tighten the hardware.
- c. Mount the pad to the pad mount(D).
- d. Repeat the steps on both sides.

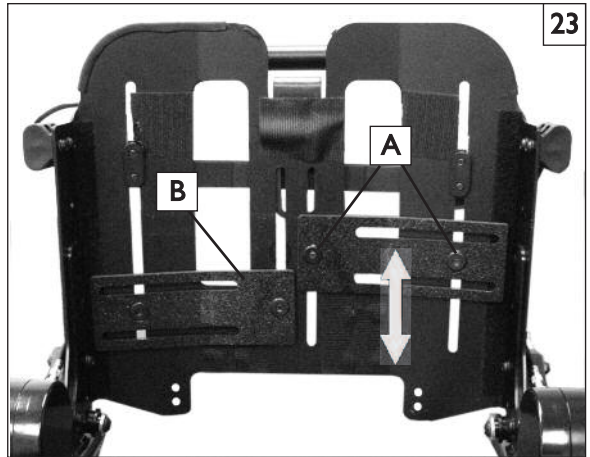

3. Setting Angle for Swing-away Trunk Support 25 26 27 28 29

- a. Unlock the Swing-away lateral and swing it out of the way to gain access to the lock-screws.
- b. Using the 4mm hex key, loosen the button head lock screws.
- c. Adjust the bracket and pad to it's optimum support position, and unlock the Lateral mechanism.
- d. Hold the adjustment in place while tightening the lock-screws.
- e. Repeat the steps on both sides.

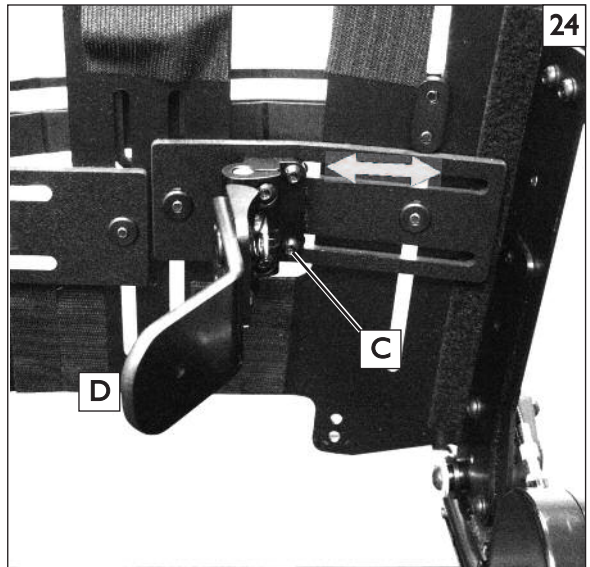

UNLOCK



LOOSEN

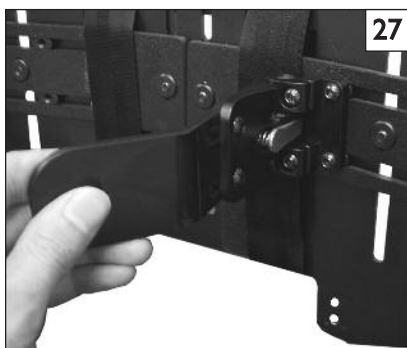

ADJUST



UNLOCK AGAIN



TIGHTEN

INSTALLING THE HEADREST

The Headrest can be mounted to the backshell using 2x 2-hole slide nut, 2x M6x1x16 bolts, 2x 1/4-28 x 5/8" machine screws, and 4x washers.

1. High mount position Headrest installation 30 31

- a. Mount the headrest and bracket (A) as shown, using 2x M6 bolts and washers (B), and the 2-hole slide nut.
- b. After adjusting the headrest to optimum support position, use the 4mm hex key to tighten the screws

2. Low mount position Headrest installation 32 33 34

- a. To mount the headrest in the low position, invert the bracket(A).
- b. Using the 2x M6 bolts and washers (B), and the 2-hole slide nut, attach the bracket as shown.
- c. To orient the headrest (D) right-side up, use a 3/16" hex key to remove the two 1/4-28 x 5/8 headrest screws (C) orient the headrest as shown and re-attach the screws.
- d. After adjusting the headrest to optimum support position, use the 4mm and 3/16" hex keys to make sure the screws are tight

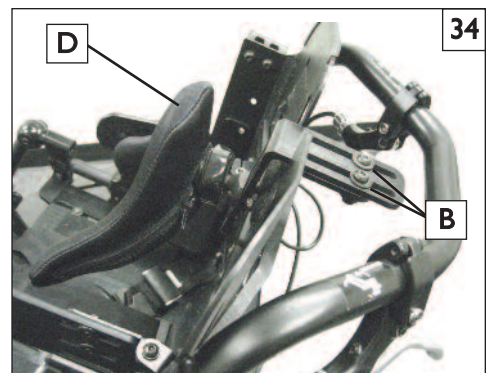
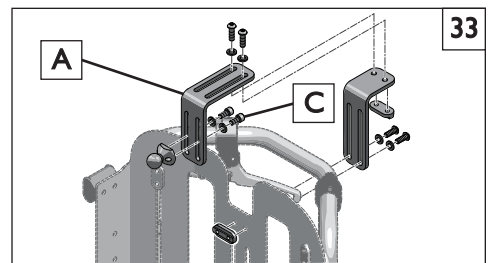
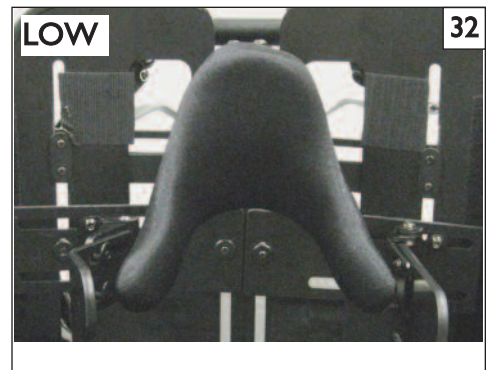
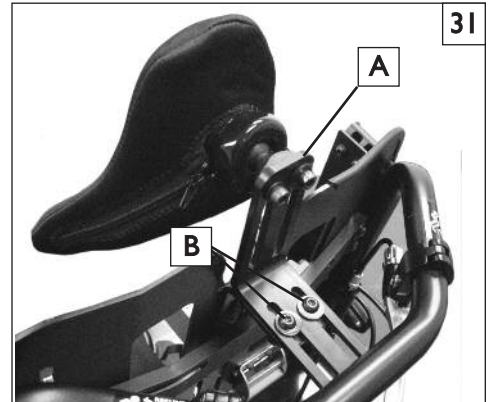
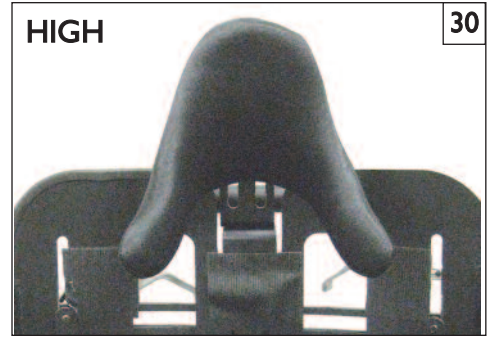

INSTALLING THE PELVIC POSITIONING BELT

The Pelvic positioning belt can be mounted using 2x M6x1x16 screws, and 2x Large washers.

⚠ WARNING

The pelvic belt is not transit approved and should not be used as a substitute for the Anterior Trunk H strap support when in a transit situation.

NOTE: Harness may be mounted to any holes or hardware available. This instruction guide shows just one of many possible mounting locations.

1. Location and Removal 35 36 37

- a. Locate the 2 T-nuts circled in Figure 36.
- b. Using a 4mm hex key, remove the screws from the two T-nuts as shown in figure 37.

2. Attaching the Pelvic belt 38 39

- a. Using a 4mm hex key with M6x1x16 screws and washers, attach each end of the pelvic belt to the underside of the seat pan by threading the screws into the T-nuts.
- b. Before tightening the screws all the way, adjust the pelvic belt straps to the desired length. Once the screws are snug, the pelvic positioning belt is completely assembled (see Figure 39)

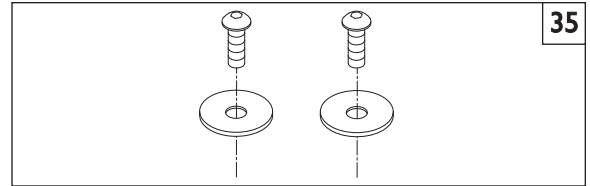

35

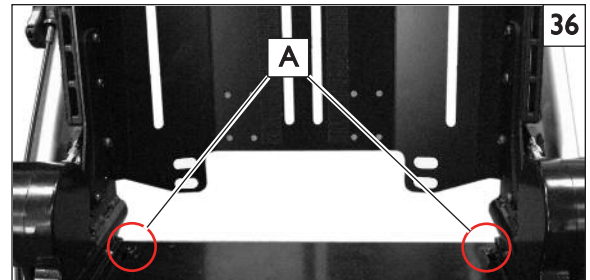

36

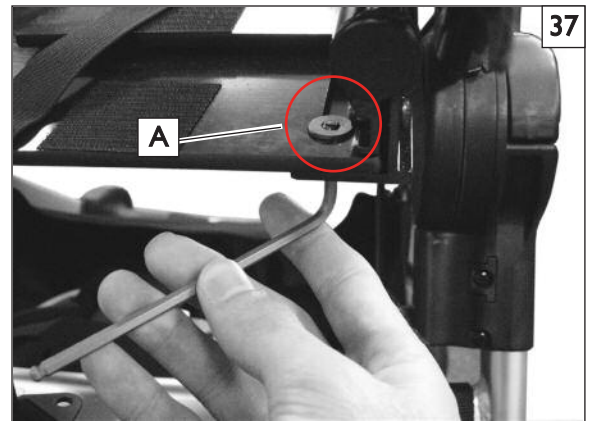

37



38



39

INSTALLING THE COMFORT FIT ATS (LI'L KIDDOS)

The ATS can be mounted to the backshell using a 4x M6x1x16 bolts, 8x washers, 4x nylock nuts.

⚠ WARNING

The ATS is not transit approved and should not be used as a substitute for the Anterior Trunk H strap support when in a transit situation.

NOTE: Harness may be mounted to any holes or hardware available. This instruction guide shows just one of many possible mounting locations.

I. Location and Attachment 40 41 42

- a. Attach each upper belt bracket to the tops of the slots (A) with a nylock nut, M6 bolt, and washers using a 4mm hex key and 10mm wrench.
- b. Using a 4mm hex key, and 10mm wrench, Attach each bottom belt bracket to the bottoms of the slots (B) with a nylock nut, M6 bolt, and washers.
- c. The completed ATS is shown in (Figure 42)

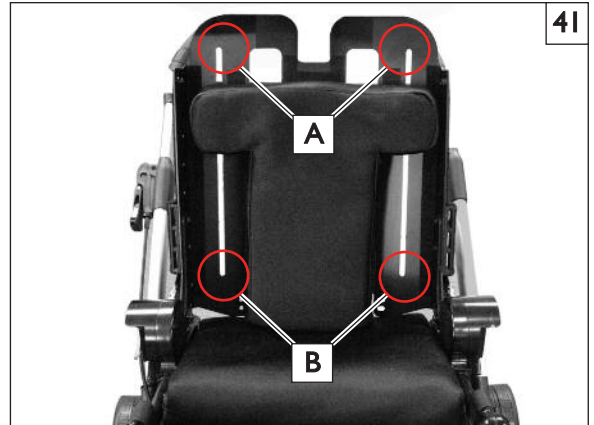
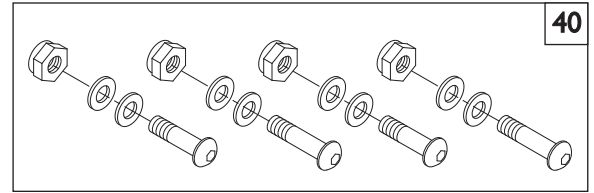

Sunrise Medical • 2842 Business Park Ave. • Fresno, CA 93727 • USA
In Canada (800) 263-3390



Customer Service: 800.333.4000
www.SunriseMedical.com

©2014 Sunrise Medical (US) LLC
7.14 IS00131 RevB