

February 2024

**Ti**

Grade 2



CE

**Customer Contact Details**

Customer Name: \_\_\_\_\_

Advisor: \_\_\_\_\_

Address: \_\_\_\_\_  
\_\_\_\_\_  
\_\_\_\_\_

Phone: \_\_\_\_\_

Email: \_\_\_\_\_

Ship to Customer Address: 

Shipping Name: \_\_\_\_\_

Shipping Address: \_\_\_\_\_  
\_\_\_\_\_  
\_\_\_\_\_

Phone: \_\_\_\_\_

Email: \_\_\_\_\_

**Additional Information**Notes: \_\_\_\_\_  
\_\_\_\_\_  
\_\_\_\_\_

Current Wheelchair: \_\_\_\_\_

Customer Weight: \_\_\_\_\_

Customer Height: \_\_\_\_\_

Customer Disability: \_\_\_\_\_

**Other**

Guide:  Base product     Required option     Optional Extra    Critical Information    Information Needed

## PRODUCT STYLE

- HXTXZ010 HILITE XTR**  
\$ 6,962.00
- XA070 Open design
- XA080 Closed design
- HXTXA085 Crash tested upgrade  
\$343.00



XA070 - Open design



XA080 - Closed design

**Max User Weight 115kg (253lbs)**

**PLEASE NOTE: ALL RGK CHAIRS ARE HAND BUILT AND HAVE A MANUFACTURING MEASUREMENT TOLERANCE OF +/- 5MM**

## CAD APPROVAL

- |   |  |
|---|--|
| <input type="checkbox"/> XW009 QUOTE ONLY (NO CAD FOR APPROVAL)   | <input type="checkbox"/> XW011 ORDER (NO CAD FOR APPROVAL)   |
| <input type="checkbox"/> XW012 QUOTE CAD drawing for approval<br>\$550 FLAT FREE (2 customer amendments ONLY) | <input type="checkbox"/> XW010 ORDER CAD drawing for approval<br>\$300 FLAT FEE (2 customer amendments ONLY) |

## KEY MEASUREMENTS

- XY010 Seat width *(Inside to inside of sideguards)*  
  (Max - 500mm)
- XY020 Seat length  
  (Max - 500mm)
- XY030 Extra Seat Length *(Provides additional leg support & hand grip)*
- XY050 Front frame height  
  (Max - 550mm)  
(Min - 380mm)
- XY060 Rear frame height  
  (Max - 550mm)  
(Min - 360mm)
- XY070 Frame length  
  (Min = XY020 + XY030 + 140mm)
- XY072 Castor position  
   
 Optimise measurements
- XA020 Ergonomic seat  
\$119.00  
*Specify length*  
  (Standard = 120mm)

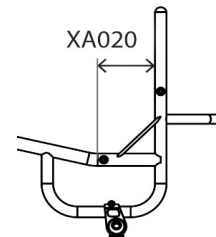
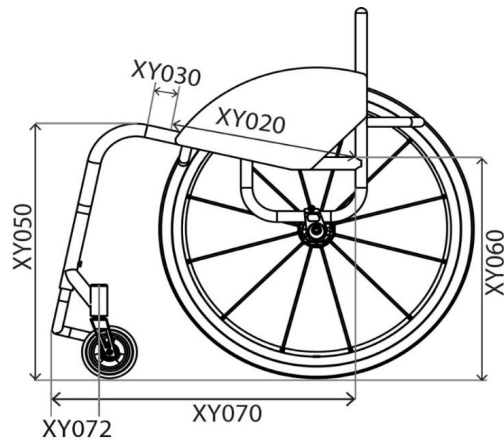
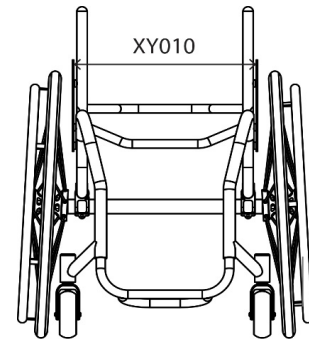

SERIAL NO: \_\_\_\_\_

## FRONT FRAME AND FOOTREST

### Front Frame Options

- XY085 Seat taper design  
\$221.00

**i** Specify width  mm

(When combined with XY091, dimension is inbetween the centre of the main bends)

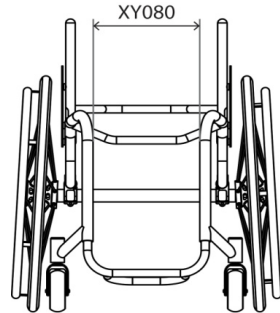

- HXTXY091 Parallel taper design  
\$157.00

**i** Specify width  mm

(When combined with XY080, dimensions must be smaller by 20mm)

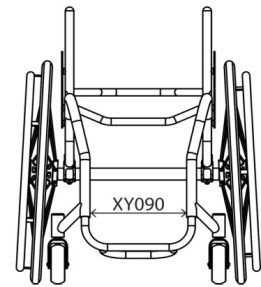

### Footrest Design (Choose One)

- XY100 Round design

Castor Size	Max Height	With XB200
3"	140mm	190mm
4"	150mm	200mm
5"	160mm	210mm

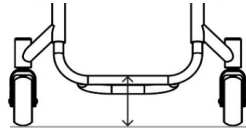

- XY105 Square design

Castor Size	Max Height	With XB200
3"	135mm	185mm
4"	145mm	195mm
5"	155mm	205mm

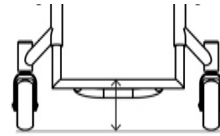

- XB200 High level footrest (Only with XB010, HXTXB080 & XB150)  
\$198.00

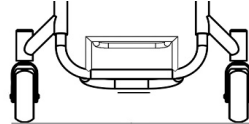

- XB200 High level footrest (Only with XB010, HXTXB080 & XB150)  
\$ 198.00

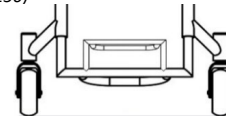

### Footrest Individual Measurements

- XY115 Front footrest height

**!**  mm

- XY120 Rear footrest height

**i**  mm

(Std = 20 lower than front height)

- XY125 Footrest length

**i**  mm

(Std = 100mm)

(160mm and over requires heavy duty upgrade XB150)

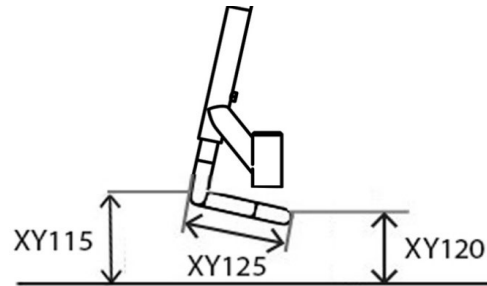

### Footrest Style (Choose One)

- XB010 Tubular aluminium footrest (Height adjustable)

- XB020 Tubular titanium footrest (Height adjustable)

- XB070 Angle adjustable aluminium footrest (Angle/height adjustable)  
\$204.00

- HXTXB080 Tubular footrest welded into frame (No height adjustment)  
\$ 244.00

- XB030 Flip up plastic footrest (Angle/height adjustable, with closed frame only)  
\$ 347.00

- XB150 Heavy duty tubular footrest (Height adjustable, for Freewheel use)  
\$ 177.00

### Footrest Cover

- XB050 Carbon fibre cover (Not with XB070 & XB030)  
\$244.00

- XB170 Aluminium cover (Not with XB070 & XB030)  
\$ 97.00

- XB165 Rubber grip tape (3M Safety walk)(not with XB030)  
\$ 85.00

SERIAL NO: \_\_\_\_\_

## CASTOR WHEELS, FORKS & WHEEL LOCKS

### Castor Wheels 100mm (4")

- XC060 Soft roll 4"x1.3"  
(Black)
- XC110 Aluminium centre 4"x1"  
\$ 229.00 (Silver hub and black urethane tyre)
- XC130 Aluminium centre 4"x1.4"  
\$ 229.00 (choose colour below)

- i**  Silver hub & black tyre (Std)     Red hub & black tyre     Purple hub & black tyre     Green hub & black tyre  
 Black hub & black tyre     Blue hub & black tyre     Gold hub & black tyre

### 125mm (5")

- XC070 Soft roll 5"x1.3"  
(Black)
- XC100 Pneumatic Aluminium centre 5"x1"  
\$ 244.00 (Grey)
- XC120 Froglegs Aluminium centre 5"x1"  
\$ 229.00 (Silver hub and black urethane tyre)
- XC140 Froglegs Aluminium centre 5"x1.4"  
\$ 229.00 (Silver hub and black urethane tyre)



### 150mm (6")

- XC080 Soft roll 6"x1.3"
- XC145 Frog Legs aluminium centre 6"x1.4"  
\$ 305.00 (Silver hub and black urethane tyre)

### Castor Forks

- XC192 Anti-Flutter castor fork  
(Std when no option selected)  
*Note: Colour follows accent*
  - XC210 Froglegs suspension castor fork  
\$ 624.00
- i**  Black     Silver

### Castor Pin Width

- XY330 Castor pin width
-  
- Optimise measurements

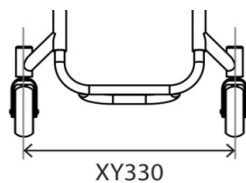

### Wheel Lock Options (choose one)

- XD020 Underseat Scissor
  - XD030 Compact scissor  
\$ 262.00
  - XD050 Push to lock
  - XD046 Out Front push to lock  
\$ 403.00
  - XD085 Eagle Brakes (Indicate colour)  
\$ 461.00
  - XD086 Eagle Brakes with L/W fixing  
\$ 500.00 (Only with fixed centre of gravity)  
(Indicate colour)
  - XD010 Omit wheel locks
- BLACK     PURPLE     RED     BLUE  
**Black Std if no option selected**

## SIDEGUARDS AND ARMRESTS

Sideguard		Sideguard with Fender	
Aluminium Options		Aluminium Options	
<input type="checkbox"/> XE030	Screw on aluminium \$ 322.00 <i>(N/A with HXTXG020)</i>	<input type="checkbox"/> XE040	Screw on aluminium with fender \$ 275.00 <i>(N/A with HXTXG020)</i>
<input type="checkbox"/> XE080	Lift out aluminium \$ 524.00 <i>(N/A with HXTXG020)</i>	<input type="checkbox"/> XE090	Lift out aluminium with fender \$ 570.00 <i>(N/A with HXTXG020)</i>
<input type="checkbox"/> HXTXE130	Fold flat aluminium \$ 680.00	<input type="checkbox"/> HXTXE140	Fold flat aluminium with fender \$ 749.00
Carbon Fibre Options		Carbon Fibre Options	
<input type="checkbox"/> XE050	Screw on carbon fibre \$ 715.00 <i>(N/A with HXTXG020)</i>	<input type="checkbox"/> XE060	Screw on carbon fibre with fender \$ 938.00 <i>(N/A with HXTXG020)</i>
<input type="checkbox"/> XE100	Lift out carbon fibre \$ 755.00 <i>(N/A with HXTXG020)</i>	<input type="checkbox"/> XE110	Lift out carbon fibre with fender \$1,115.00 <i>(N/A with HXTXG020)</i>
<input type="checkbox"/> HXTXE150	Fold flat carbon fibre \$ 1,104.00	<input type="checkbox"/> HXTXE160	Fold flat carbon fibre with fender \$1,342.00
Welded Options		Sideguard Measurements	
<input type="checkbox"/> HXTXE220	Welded Titanium \$ 727.00 <i>(N/A with HXTXG020)</i>	Fender Height	
Armrest Options		<input type="checkbox"/> 10mm above tyre <i>(Standard)</i>	
<input type="checkbox"/> XF010	Lift out armrest with plastic sideguard \$ 583.00 <i>(Indicate fixed height)</i>	<input type="checkbox"/> Individual above tyre <i>(Min = 10mm)</i>	
<input type="checkbox"/> XF020	Lift out armrest with Aluminium sideguard \$ 460.00 <i>(Indicate fixed height)</i>	<input type="checkbox"/> <input type="text" value=""/> mm	
Height (Top of seatrail to top of armrest)		Fender position	
<input type="checkbox"/> <input type="text" value=""/> mm		<input type="checkbox"/> Centre of tyre <i>(Standard if no option selected)</i>	
Sideguard Measurements		<input type="checkbox"/> Outside of tyre	
Optimised measurements			
<input type="checkbox"/> 25mm above tyre <i>(Follow tyre)</i>			
<input type="checkbox"/> Individual above tyre <i>(Follow tyre)</i>			
<input type="checkbox"/> <input type="text" value=""/> mm			
<input type="checkbox"/> Level with tyre <i>(Follow tyre)</i>			
Individual measurements			
<input type="checkbox"/> Sideguard length			
<input type="checkbox"/> <input type="text" value=""/> mm			
<input type="checkbox"/> Sideguard height			
<input type="checkbox"/> <input type="text" value=""/> mm			

SERIAL NO: \_\_\_\_\_

## BACKREST

Backrest Height - Fixed or Adjustable (Choose One)

XY230 Fixed height backrest

**i** Specify height  
mm

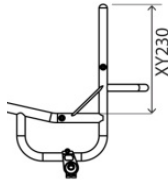

XY245 Adjustable height backrest (+/25mm)  
\$ 244.00

**i** Specify height  
mm

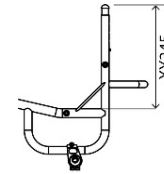

Backrest Design (Choose one)

XG010 Fixed backrest (Non-folding)

HXTXG021 Folding backrest (Oracing style)  
\$ 714.00

HXTXG020 Folding backrest (with 2 position snap lock and angle adjust +5 Deg)  
\$ 714.00

Ergonomic Options

XY360 Backrest angle

**i** -5 -3 0 +3 +5  
Individual  
Deg  
(Max -10/+20 Deg)

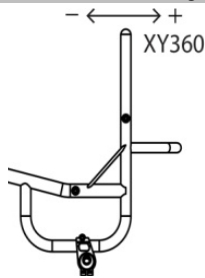

XG100 Ergonomic backrest  
\$ 144.00

**i** Vertical height  
mm

**i** Rearward position  
mm

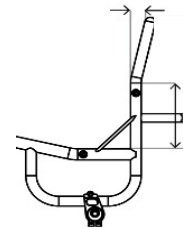

XG110 Inward taper (inside of backrest posts)  
\$ 144.00

**i** Specify width or per side  
mm

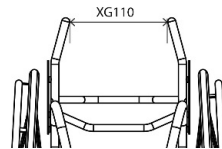

XG120 Outward flare (inside of backrest posts)  
\$ 144.00

**i** Specify width or per side  
mm

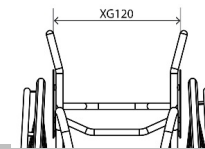

Push handle Options

XG070 Screw in push handles (N/A with XY245)  
\$ 222.00

HXTXG090 Stroller push handles height adjustable (Oracing style)  
\$ 535.00

XG080 Flip down push handles (N/A with XY245)  
\$ 434.00

**i** Height from floor  
mm  Optimise (1000mm from floor)

XG085 Flip down push handles height adjustable (N/A with XY245)  
\$ 709.00

XG097 Integrated push handle (quickie design)  
\$ 666.00

Backrest Options

XG040 Heavy duty backrest upgrade (Recommended for hand cycling) (Not with XY245)  
\$ 204.00

XG130 Extra deep brace bar (Recommended for JAY backs) (Std - 90mm)  
\$ 113.00

**i** Specify depth  
mm

ILSA Backrest Options

XG140 Integrated lateral support  
\$ 472.00

A - Left  
mm

A - Right  
mm

B - Left  
mm

B - Right  
mm

C - Left  
mm

C - Right  
mm

D - Left  
mm

D - Right  
mm

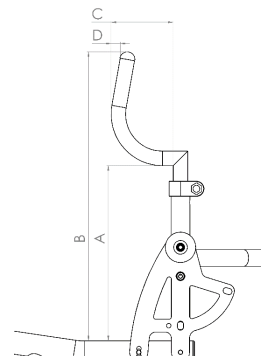

## CAMBER BAR

### Adjustable Centre of Gravity

XH110 Square back adjustable centre of gravity

(25-150mm)

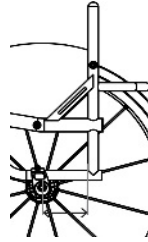

XH120 Round back adjustable centre of gravity

(60-150mm)

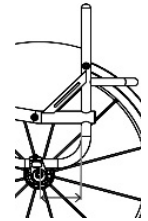

HCTXH090 V-style fixed centre of gravity  
\$ 645.00 (Open frame only)

(25-125mm)

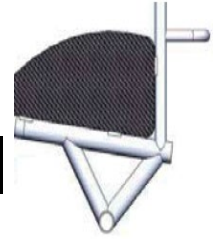

HCTXH105 Fixed centre of gravity  
\$ 645.00 (Closed frame only)

(25-125mm)



### Specify Camber Angle

XY390 Camber angle

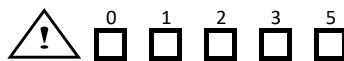

XY390 Camber angle

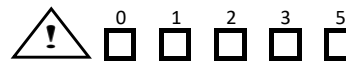

### Camber Bar Options

XH040 Handbike camber bar fixed  
\$ 394.00

Camber angle (Handbike camber bar)

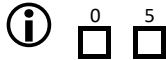

Castor height from floor for handbike fitting  
(Standard 30mm if not indicated)

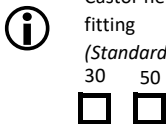

XH040 Handbike camber bar fixed  
\$ 394.00

Camber angle (Handbike camber bar)

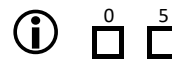

Castor height from floor for handbike fitting  
(Standard 30mm if not indicated)

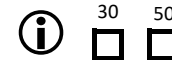

### Anti-Tip Options

XJ010 Swingaway anti tip LEFT side (Only with square back frame. Not with XH040)  
\$ 165.00

XJ020 Swingaway anti tip RIGHT side (Only with square back frame. Not with XH040)  
\$ 165.00

XJ100 Single sport anti tip (centre mounted)  
\$ 497.00

REAR WHEELS	
Rear Wheel Size	
<input type="checkbox"/> XY420 24" Wheels	<input type="checkbox"/> XY430 25" Wheels
Rear Wheel Gap	
<input checked="" type="checkbox"/> XY460 Rear wheel gap  XY460 <div style="display: flex; align-items: center; margin-top: 5px;"> <div style="text-align: center; margin-right: 20px;"> <p>15 <input type="checkbox"/> 20 <input type="checkbox"/> 25 <input type="checkbox"/></p> </div> <div style="border: 1px solid black; width: 100px; height: 20px; display: flex; align-items: center; justify-content: center;"> <span>mm</span> </div> </div>	
Wheel Options (Choose one)	
<input type="checkbox"/> XK010 Fusion 16 spoke <i>(Silver Hub, black spokes)</i> <input type="checkbox"/> XK050 Spinergy LX 12 spoke \$ 985.00 <input type="checkbox"/> XK150 Spinergy CLX 18 carbon blade spoke \$ 3,093.00 <i>N/A IN SILVER HUB</i>	<input type="checkbox"/> XK320 Spinergy XLX 12 spoke \$1,051.00 <input type="checkbox"/> XK060 Spinergy SPOX 18 spoke \$ 655.00 <input type="checkbox"/> XK070 Spinergy BLXL 18 blade spoke \$1,051.00 <i>N/A IN SILVER HUB</i>
<b>Spinergy Colour Options:</b> ( i ) <div style="display: flex; flex-wrap: wrap;"> <div style="width: 33%;"><input type="checkbox"/> Black spokes</div> <div style="width: 33%;"><input type="checkbox"/> White spokes</div> <div style="width: 33%;"><input type="checkbox"/> Yellow spokes</div> <div style="width: 33%;"><input type="checkbox"/> Red spokes</div> <div style="width: 33%;"><input type="checkbox"/> Blue spokes</div> <div style="width: 33%;"><input type="checkbox"/> Pink spokes</div> <div style="width: 33%;"><input type="checkbox"/> Purple spokes</div> <div style="width: 33%;"><input type="checkbox"/> Orange spokes</div> <div style="width: 33%;"><input type="checkbox"/> Green spokes</div> </div>	
<input type="checkbox"/> XK180 Individual spoke design \$ 210.00 <i>Inside: _____</i> <i>Outside: _____</i>	
<b>Spinergy Anodise Options</b> <input type="checkbox"/> XK190 Black hub <i>(std option)</i> <input type="checkbox"/> XK200 Silver hub \$125.00 <i>(n/a with BLXL/CLX)</i> <input type="checkbox"/> XK201 Red hub/rims \$403.00 <i>(LX, XLX &amp; BLXL only)</i> <input type="checkbox"/> XK205 Individual: \$560.00 <i>Select colour: _____</i> <input type="checkbox"/> XK202 Purple hub/rims \$403.00 <i>(LX, XLX &amp; BLXL only)</i> <input type="checkbox"/> XK203 Blue hub/rims \$403.00 <i>(LX, XLX &amp; BLXL only)</i> <input type="checkbox"/> XK204 Gold hub/rims \$531.00 <i>(LX, XLX &amp; BLXL only)</i>	
Supply Without Wheels	
<input type="checkbox"/> XK040 Supply without Wheels	( i ) <span style="border: 1px solid black; padding: 2px;">Wheel Type: _____</span> <span style="border: 1px solid black; padding: 2px; margin-left: 20px;">Tyre Type: _____</span>
Handrim Position / Options	
<input type="checkbox"/> XY480 Narrow set handrim	<input type="checkbox"/> XY485 Wide set handrim
<input type="checkbox"/> XL090 Remove excess mounting tabs \$144.00 <i>(recommended for small wheel gaps)</i>	
Handrim Styles	
<input type="checkbox"/> XL010 Aluminium hard anodised 6 tab	<input type="checkbox"/> XL040 Titanium 6 tab \$ 439.00
<input type="checkbox"/> XL160 Ellipse 6 tab \$622.00 <i>(replacement for Surge)</i>	<input type="checkbox"/> XL035 Natural Fit LT \$ 732.00
<input type="checkbox"/> XL020 Tetra grip 6 tab \$394.00	<input type="checkbox"/> XL150 Carbolife Gekko <input type="checkbox"/> Black <input type="checkbox"/> Silver \$1,385.00
<input type="checkbox"/> XL100 Para grip 6 tab \$394.00	<input type="checkbox"/> XL170 Carbolife Curve L (Black) \$1,372.00
Tyre Options	
<input type="checkbox"/> XM010 Kenda <input type="checkbox"/> Grey <input type="checkbox"/> Blue <input type="checkbox"/> Red <i>(Std)</i> <input type="checkbox"/> XM130 Kenda black \$ 27.00 <input type="checkbox"/> XM020 Schwalbe Marathon Plus \$ 97.00 <input type="checkbox"/> XM040 Shox solid airless (Black) \$158.00	<input type="checkbox"/> XM060 Schwalbe One (24", 25" only) \$ 131.00 <input type="checkbox"/> XM050 Kenda K885 mountain bike tyre (24", 25" only) \$ 39.00
Inner Tube Valve Options	
<input type="checkbox"/> XY500 Schraeder inner tube valve <i>(Standard if no option selected)</i>	<input type="checkbox"/> XY490 Presta inner tube valve
Wheel Accessories	
<input type="checkbox"/> XK220 Titanium quick release axle pins (pair) <i>(N/A with XK010 &amp; XK070)</i> \$158.00	<input type="checkbox"/> XK300 Offroad wheel set 22" rim with handrim, MTB tyre and axle pins <i>(Replaces 24" wheel with XM010)</i> \$ 919.00
<input type="checkbox"/> XK240 Quad release axle nuts (pair) \$237.00	<input type="checkbox"/> XK310 Offroad wheel set 24" rim with handrim, MTB tyre and axle pins <i>(Replaces 25" wheel with XM010)</i> \$ 919.00



SERIAL NO: \_\_\_\_\_

FINISH OPTIONS																																																																
Frame & Component Finish																																																																
<input type="checkbox"/> XN010 Powder coated frame  <table style="width: 100%; border-collapse: collapse;"> <thead> <tr> <th style="text-align: left; font-size: small;">Frame Comp.</th> <th style="text-align: left; font-size: small;"><u>Gloss</u></th> </tr> </thead> <tbody> <tr><td><input type="checkbox"/> <input type="checkbox"/></td><td>Black gloss 103</td></tr> <tr><td><input type="checkbox"/> <input type="checkbox"/></td><td>White gloss 100</td></tr> <tr><td><input type="checkbox"/> <input type="checkbox"/></td><td>Grey gloss 132</td></tr> <tr><td><input type="checkbox"/> <input type="checkbox"/></td><td>Cream gloss 135</td></tr> <tr><td><input type="checkbox"/> <input type="checkbox"/></td><td>Red gloss 108</td></tr> <tr><td><input type="checkbox"/> <input type="checkbox"/></td><td>Yellow gloss 120</td></tr> <tr><td><input type="checkbox"/> <input type="checkbox"/></td><td>Forest green gloss 143</td></tr> <tr><td><input type="checkbox"/> <input type="checkbox"/></td><td>Green gloss 107</td></tr> <tr><td><input type="checkbox"/> <input type="checkbox"/></td><td>Dark blue gloss 151</td></tr> <tr><td><input type="checkbox"/> <input type="checkbox"/></td><td>Royal blue gloss 154</td></tr> <tr><td><input type="checkbox"/> <input type="checkbox"/></td><td>Blue gloss 174</td></tr> <tr><td><input type="checkbox"/> <input type="checkbox"/></td><td>Duckegg blue gloss 141</td></tr> <tr><td><input type="checkbox"/> <input type="checkbox"/></td><td>Pink gloss 188</td></tr> <tr><td><input type="checkbox"/> <input type="checkbox"/></td><td>Orange gloss 180</td></tr> <tr><td><input type="checkbox"/> <input type="checkbox"/></td><td>Purple gloss 157</td></tr> </tbody> </table>	Frame Comp.	<u>Gloss</u>	<input type="checkbox"/> <input type="checkbox"/>	Black gloss 103	<input type="checkbox"/> <input type="checkbox"/>	White gloss 100	<input type="checkbox"/> <input type="checkbox"/>	Grey gloss 132	<input type="checkbox"/> <input type="checkbox"/>	Cream gloss 135	<input type="checkbox"/> <input type="checkbox"/>	Red gloss 108	<input type="checkbox"/> <input type="checkbox"/>	Yellow gloss 120	<input type="checkbox"/> <input type="checkbox"/>	Forest green gloss 143	<input type="checkbox"/> <input type="checkbox"/>	Green gloss 107	<input type="checkbox"/> <input type="checkbox"/>	Dark blue gloss 151	<input type="checkbox"/> <input type="checkbox"/>	Royal blue gloss 154	<input type="checkbox"/> <input type="checkbox"/>	Blue gloss 174	<input type="checkbox"/> <input type="checkbox"/>	Duckegg blue gloss 141	<input type="checkbox"/> <input type="checkbox"/>	Pink gloss 188	<input type="checkbox"/> <input type="checkbox"/>	Orange gloss 180	<input type="checkbox"/> <input type="checkbox"/>	Purple gloss 157	<input type="checkbox"/> XN150 Powder coated components <i>(Frame colour if not specified)</i>  <table style="width: 100%; border-collapse: collapse;"> <thead> <tr> <th style="text-align: left; font-size: small;">Frame Comp.</th> <th style="text-align: left; font-size: small;"><u>Matt</u></th> </tr> </thead> <tbody> <tr><td><input type="checkbox"/> <input type="checkbox"/></td><td>Black matt 105</td></tr> <tr><td><input type="checkbox"/> <input type="checkbox"/></td><td>White matt 101</td></tr> <tr><td><input type="checkbox"/> <input type="checkbox"/></td><td>Grey matt 131</td></tr> <tr><td><input type="checkbox"/> <input type="checkbox"/></td><td>Light grey matt 133</td></tr> <tr><td><input type="checkbox"/> <input type="checkbox"/></td><td>Navy blue matt 152</td></tr> </tbody> </table>	Frame Comp.	<u>Matt</u>	<input type="checkbox"/> <input type="checkbox"/>	Black matt 105	<input type="checkbox"/> <input type="checkbox"/>	White matt 101	<input type="checkbox"/> <input type="checkbox"/>	Grey matt 131	<input type="checkbox"/> <input type="checkbox"/>	Light grey matt 133	<input type="checkbox"/> <input type="checkbox"/>	Navy blue matt 152	<table style="width: 100%; border-collapse: collapse;"> <thead> <tr> <th style="text-align: left; font-size: small;">Frame Comp.</th> <th style="text-align: left; font-size: small;"><u>Special</u></th> </tr> </thead> <tbody> <tr><td><input type="checkbox"/> <input type="checkbox"/></td><td>Chrome Mirror 300</td></tr> <tr><td><input type="checkbox"/> <input type="checkbox"/></td><td>Sparkle silver 170</td></tr> <tr><td><input type="checkbox"/> <input type="checkbox"/></td><td>Metallic black matt 104</td></tr> <tr><td><input type="checkbox"/> <input type="checkbox"/></td><td>Metallic grey matt 130</td></tr> <tr><td><input type="checkbox"/> <input type="checkbox"/></td><td>Black sandpaper 201</td></tr> <tr><td><input type="checkbox"/> <input type="checkbox"/></td><td>Grey sandpaper 202</td></tr> <tr><td><input type="checkbox"/> <input type="checkbox"/></td><td>White sandpaper 200</td></tr> </tbody> </table>	Frame Comp.	<u>Special</u>	<input type="checkbox"/> <input type="checkbox"/>	Chrome Mirror 300	<input type="checkbox"/> <input type="checkbox"/>	Sparkle silver 170	<input type="checkbox"/> <input type="checkbox"/>	Metallic black matt 104	<input type="checkbox"/> <input type="checkbox"/>	Metallic grey matt 130	<input type="checkbox"/> <input type="checkbox"/>	Black sandpaper 201	<input type="checkbox"/> <input type="checkbox"/>	Grey sandpaper 202	<input type="checkbox"/> <input type="checkbox"/>	White sandpaper 200	<input type="checkbox"/> RGK-XN200 Individual paint colour (State Colour/RAL code) Frame Comp \$ 557.00 <input type="checkbox"/> <input type="checkbox"/>	
Frame Comp.	<u>Gloss</u>																																																															
<input type="checkbox"/> <input type="checkbox"/>	Black gloss 103																																																															
<input type="checkbox"/> <input type="checkbox"/>	White gloss 100																																																															
<input type="checkbox"/> <input type="checkbox"/>	Grey gloss 132																																																															
<input type="checkbox"/> <input type="checkbox"/>	Cream gloss 135																																																															
<input type="checkbox"/> <input type="checkbox"/>	Red gloss 108																																																															
<input type="checkbox"/> <input type="checkbox"/>	Yellow gloss 120																																																															
<input type="checkbox"/> <input type="checkbox"/>	Forest green gloss 143																																																															
<input type="checkbox"/> <input type="checkbox"/>	Green gloss 107																																																															
<input type="checkbox"/> <input type="checkbox"/>	Dark blue gloss 151																																																															
<input type="checkbox"/> <input type="checkbox"/>	Royal blue gloss 154																																																															
<input type="checkbox"/> <input type="checkbox"/>	Blue gloss 174																																																															
<input type="checkbox"/> <input type="checkbox"/>	Duckegg blue gloss 141																																																															
<input type="checkbox"/> <input type="checkbox"/>	Pink gloss 188																																																															
<input type="checkbox"/> <input type="checkbox"/>	Orange gloss 180																																																															
<input type="checkbox"/> <input type="checkbox"/>	Purple gloss 157																																																															
Frame Comp.	<u>Matt</u>																																																															
<input type="checkbox"/> <input type="checkbox"/>	Black matt 105																																																															
<input type="checkbox"/> <input type="checkbox"/>	White matt 101																																																															
<input type="checkbox"/> <input type="checkbox"/>	Grey matt 131																																																															
<input type="checkbox"/> <input type="checkbox"/>	Light grey matt 133																																																															
<input type="checkbox"/> <input type="checkbox"/>	Navy blue matt 152																																																															
Frame Comp.	<u>Special</u>																																																															
<input type="checkbox"/> <input type="checkbox"/>	Chrome Mirror 300																																																															
<input type="checkbox"/> <input type="checkbox"/>	Sparkle silver 170																																																															
<input type="checkbox"/> <input type="checkbox"/>	Metallic black matt 104																																																															
<input type="checkbox"/> <input type="checkbox"/>	Metallic grey matt 130																																																															
<input type="checkbox"/> <input type="checkbox"/>	Black sandpaper 201																																																															
<input type="checkbox"/> <input type="checkbox"/>	Grey sandpaper 202																																																															
<input type="checkbox"/> <input type="checkbox"/>	White sandpaper 200																																																															
<input type="checkbox"/> HXTXN030 Bead blast frame (Raw) \$465.00 <i>(All parts black unless XN165 chosen)</i>		<input type="checkbox"/> XN165 Bead blast components \$ 246.00																																																														
Accent Colour																																																																
<b>Note:</b> Accent colour includes forks & castor caps.																																																																
<input type="checkbox"/> Black accent		<input type="checkbox"/> Silver accent																																																														
<input type="checkbox"/> Red accent		<input type="checkbox"/> Blue accent																																																														
<input type="checkbox"/> Purple accent																																																																
UPHOLSTERY																																																																
Seat Upholstery																																																																
<input type="checkbox"/> XP040 Seat sling adjustable tension with straps			<input type="checkbox"/> XR050 Carbon fibre seat plate \$ 473.00																																																													
Backrest Upholstery																																																																
<input type="checkbox"/> XP050 Airtech backrest strap adjustable			<input type="checkbox"/> XP070 Backrest upgrade to leather corners (Black) \$ 119.00																																																													
Backrest Stitching Options																																																																
<input type="checkbox"/> Silver	<input type="checkbox"/> Black	<input type="checkbox"/> Blue	<input type="checkbox"/> Individual: _____																																																													
<input type="checkbox"/> Red	<input type="checkbox"/> Orange	<input type="checkbox"/> Purple	_____																																																													
RGK Logo Colour																																																																
<input type="checkbox"/> White (Std)	<input type="checkbox"/> Green	<input type="checkbox"/> Blue	<input type="checkbox"/> Individual: _____																																																													
<input type="checkbox"/> Red	<input type="checkbox"/> Orange	<input type="checkbox"/> Purple	_____																																																													
Model Logo Colour																																																																
<input type="checkbox"/> White (Std)	<input type="checkbox"/> Green	<input type="checkbox"/> Blue	<input type="checkbox"/> Individual: _____																																																													
<input type="checkbox"/> Red	<input type="checkbox"/> Orange	<input type="checkbox"/> Purple	_____																																																													
Backrest Accessories																																																																
<input type="checkbox"/> XP110 Backrest with zip pocket \$ 125.00																																																																

SERIAL NO: \_\_\_\_\_

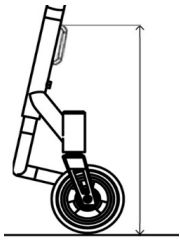
CUSHION	
Cushion foam options	
<input type="checkbox"/> XP080	Cushion foam \$ 119.00 <i>(select density and size below)</i>
<input type="checkbox"/> Soft (CMS040)	<input type="checkbox"/> Medium (CMS050)
<input type="checkbox"/> 50mm	<input type="checkbox"/> 75mm <input type="checkbox"/> 100mm
Cushion cover options	
<input type="checkbox"/> XP085	Nylon cushion cover <i>(Black)</i>
<input type="checkbox"/> XP090	Air Lite cushion cover \$ 97.00 <i>(Black)</i>
<input type="checkbox"/> XP100	Leather cushion cover \$ 250.00 <i>(Black)</i>
Jay Products - PLEASE ATTACH JAY ORDER FORM	
<input type="checkbox"/> JAY Cushion	<input type="checkbox"/> Jay Order form attached <i>(Price dependant on size / option)</i>
<input type="checkbox"/> JAY Backrest	<input type="checkbox"/> Jay Order form attached <i>(Price dependant on size / option)</i>
<input type="checkbox"/> JAY Whitmyer Headrest	<input type="checkbox"/> Jay Order form attached <i>(Price dependant on size / option)</i>
FRAME OPTIONS	
<input type="checkbox"/> XR060	Welded calf strap mounting loops \$ 152.00 <i>(To locate calf strap on front frame)</i>
	Specify height from floor <input style="width: 100px; height: 20px;" type="text"/>
<input type="checkbox"/>	Optimise measurements
	
ACCESSORIES	
<input type="checkbox"/> XR080	Frontwheel assembly \$1,037.00 <i>(Only with Tubular style footrest)</i>
<input type="checkbox"/> XP120	Frame protectors Neoprene zip fasten \$ 83.00 <i>(Black)</i>
<input type="checkbox"/> XP420	Frame protectors Nylon velcro fasten \$ 80.00 <i>(Black)</i>
<input type="checkbox"/> XR010	Seat pouch velcro attach \$ 58.00 <i>(Black)</i>
<input type="checkbox"/> XR200	Rucksack with RGK logo \$ 149.00 <i>(Black)</i>
<input type="checkbox"/> XR020	Underseat large storage bag \$ 125.00 <i>(Black)</i>
<input checked="" type="checkbox"/> XR090	Tool kit
<input checked="" type="checkbox"/> XS060	Calf strap

SERIAL NO: \_\_\_\_\_

## ADDITIONAL NOTES

