

**Ti**  
Grade 2



CE

**Customer Contact Details**

Customer Name: \_\_\_\_\_

Advisor: \_\_\_\_\_

Address: \_\_\_\_\_

\_\_\_\_\_

\_\_\_\_\_

Phone: \_\_\_\_\_

Email: \_\_\_\_\_

Shipping Name: \_\_\_\_\_

Shipping Address: \_\_\_\_\_

\_\_\_\_\_

\_\_\_\_\_

Phone: \_\_\_\_\_

Email: \_\_\_\_\_

**Additional Information**

Notes: \_\_\_\_\_

\_\_\_\_\_

\_\_\_\_\_

\_\_\_\_\_

Current Wheelchair: \_\_\_\_\_

Customer Weight: \_\_\_\_\_

Customer Height: \_\_\_\_\_

Customer Disability: \_\_\_\_\_

**Other**

\_\_\_\_\_

\_\_\_\_\_

<p><b>Guide:</b></p> <span style="display: inline-block; width: 15px; height: 15px; background-color: black; border-radius: 50%; margin-right: 5px;"></span> Base product <span style="display: inline-block; width: 15px; height: 15px; background-color: black; margin-left: 20px; margin-right: 5px;"></span> Required option <span style="display: inline-block; width: 15px; height: 15px; border: 1px solid black; margin-left: 20px; margin-right: 5px;"></span> Optional Extra <span style="display: inline-block; width: 15px; height: 15px; border: 1px solid black; margin-left: 20px; margin-right: 5px; text-align: center; vertical-align: middle;">!</span> Critical Information <span style="display: inline-block; width: 15px; height: 15px; border: 1px solid black; margin-left: 20px; margin-right: 5px; text-align: center; vertical-align: middle;">i</span> Information Needed	
PRODUCT STYLE	
<p><input checked="" type="radio"/> <b>TMLXZ010</b>    <b>MAXLITE</b> \$ 7,329.00</p> <p><input checked="" type="checkbox"/> XA080    Closed design</p> <p><b>Max User Weight 100kg (220lbs)</b></p> <p><b>PLEASE NOTE: ALL RGK CHAIRS ARE HAND BUILT AND HAVE A MANUFACTURING MEASUREMENT TOLERANCE OF +/- 5MM</b></p>	
CAD APPROVAL	
<input type="checkbox"/> XW009    QUOTE ONLY (NO CAD FOR APPROVAL) No Charge	<input type="checkbox"/> XW011    ORDER (NO CAD FOR APPROVAL) No Charge
<input type="checkbox"/> XW012    QUOTE CAD drawing for approval \$550 FLAT FEE (2 customer amendments ONLY)	<input type="checkbox"/> XW010    ORDER CAD drawing for approval \$300 FLAT FEE (2 customer amendments ONLY)
KEY MEASUREMENTS	
<p><input checked="" type="checkbox"/> XY010    Seat width (<i>Inside of sideguards</i>)</p> <div style="display: flex; align-items: center;"> <span style="font-size: 2em; margin-right: 10px;">!</span> <div style="border: 1px solid black; width: 100px; height: 20px; margin-right: 10px; display: flex; align-items: center; justify-content: center;">mm</div> <div style="margin-left: 10px;"> <p>(Max - 440mm)</p> <p>(Min - 250mm)</p> </div> </div> <p><input checked="" type="checkbox"/> XY020    Seat length</p> <div style="display: flex; align-items: center;"> <span style="font-size: 2em; margin-right: 10px;">!</span> <div style="border: 1px solid black; width: 100px; height: 20px; margin-right: 10px; display: flex; align-items: center; justify-content: center;">mm</div> <div style="margin-left: 10px;"> <p>(Max - 440mm)</p> <p>(Min - 250mm)</p> </div> </div> <p><input type="checkbox"/> XY030    Extra seat length (<i>Provides additional leg support &amp; hand grip</i>)</p> <div style="display: flex; align-items: center;"> <span style="font-size: 2em; margin-right: 10px;">i</span> <div style="border: 1px solid black; width: 100px; height: 20px; margin-right: 10px; display: flex; align-items: center; justify-content: center;">mm</div> </div> <p><input checked="" type="checkbox"/> XY050    Front frame height</p> <div style="display: flex; align-items: center;"> <span style="font-size: 2em; margin-right: 10px;">!</span> <div style="border: 1px solid black; width: 100px; height: 20px; margin-right: 10px; display: flex; align-items: center; justify-content: center;">mm</div> <div style="margin-left: 10px;"> <p>(Max - 550mm)</p> <p>(Min - 380mm)</p> </div> </div> <p><input checked="" type="checkbox"/> XY060    Rear frame height</p> <div style="display: flex; align-items: center;"> <span style="font-size: 2em; margin-right: 10px;">!</span> <div style="border: 1px solid black; width: 100px; height: 20px; margin-right: 10px; display: flex; align-items: center; justify-content: center;">mm</div> <div style="margin-left: 10px;"> <p>(Max - 550mm)</p> <p>(Min - 360mm)</p> </div> </div> <p><input checked="" type="checkbox"/> XY070    Frame length</p> <div style="display: flex; align-items: center;"> <span style="font-size: 2em; margin-right: 10px;">!</span> <div style="border: 1px solid black; width: 100px; height: 20px; margin-right: 10px; display: flex; align-items: center; justify-content: center;">mm</div> <div style="margin-left: 10px;"> <p>(Max - 650mm)</p> <p>(Min XY020 + XY030 + 110mm)</p> </div> </div> <p><input checked="" type="checkbox"/> XY072    Castor position</p> <div style="display: flex; align-items: center;"> <span style="font-size: 2em; margin-right: 10px;">i</span> <div style="border: 1px solid black; width: 100px; height: 20px; margin-right: 10px; display: flex; align-items: center; justify-content: center;">mm</div> </div> <p><input type="checkbox"/> <i>Optimise measurements</i></p> <p><input type="checkbox"/> XA020    Frame ergonomic seat \$119.00</p> <div style="display: flex; align-items: center;"> <span style="font-size: 2em; margin-right: 10px;">i</span> <div style="border: 1px solid black; width: 100px; height: 20px; margin-right: 10px; display: flex; align-items: center; justify-content: center;">mm</div> <div style="margin-left: 10px;"> <p><i>Specify length</i></p> <p>(Standard = 120mm)</p> </div> </div>	

## FRONT FRAME AND FOOTREST

### Front Frame Options

XY080 Seat taper design

**i** Specify width  mm

(When combined with XY091, dimension is inbetween the centre of the main bends)

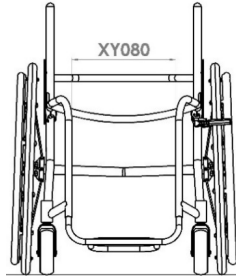

XY091 Parallel taper design

**i** Specify width  mm

(When combined with XY080, Dimensions must be smaller)

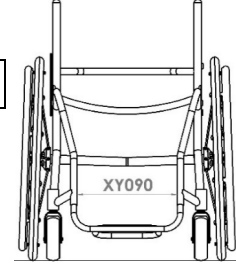

### Footrest Design (Choose One)

XY100 Round design

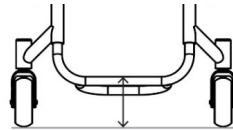

XY105 Square design

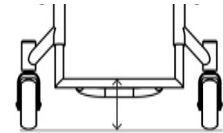

XB200 High level footrest (Only with XB010, XB080 & XB150)  
\$ 198.00

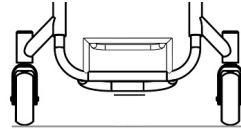

XB200 High level footrest (Only with XB010, XB080 & XB150)  
\$ 198.00

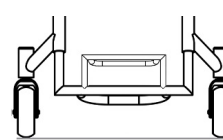

### Footrest Individual Measurements

XY115 Front footrest height

**!**  mm

XY120 Rear footrest height

**i**  mm (Std = 20 lower than front height)

XY125 Footrest length

**i**  mm (Std = 100mm) (160mm and over requires heavy duty upgrade XB150)

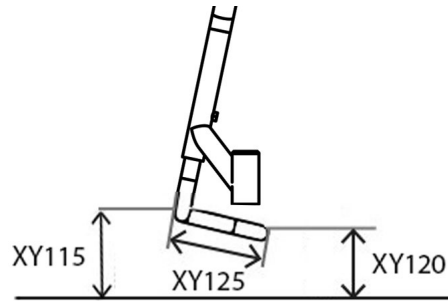

### Footrest Style

XB020 Tubular titanium footrest (Height adjustable)

XB030 Flip up plastic footrest (Angle/height adjustable)  
\$ 347.00

XB070 Angle adjust aluminium footrest (Angle/height adjustable)  
\$ 204.00

XB150 Heavy duty tubular footrest (Height adjustable)  
\$ 177.00

TMLXB080 Tubular footrest welded into frame (No height adjustment)  
\$ 166.00

### Footrest Cover

XB050 Carbon fibre cover (Not XB070 & XB030)  
\$ 244.00

XB170 Aluminium cover (Not XB070 & XB030)  
\$ 97.00

XB040 Plastic Cover (Not XB070 & XB030)  
\$ 97.00

XB165 Rubber grip tape (not with XB030) (3M Safety walk)  
\$ 85.00

CASTOR WHEELS, FORKS & WHEEL LOCKS			
Castor Wheels			
100mm (4")			
<input type="checkbox"/> XC060	Soft roll 4"x1.3" <i>(Black only)</i>		
<input type="checkbox"/> XC110 \$ 229.00	Aluminium centre 4"x1" <i>(Silver hub and black urethane tyre only)</i>		
<input type="checkbox"/> XC130 \$ 229.00	Aluminium centre 4"x1.4" <i>(choose colour below)</i>		
<input type="checkbox"/> Silver hub & black tyre <input type="checkbox"/> Black hub & black tyre <input type="checkbox"/> Red hub & black tyre	<input type="checkbox"/> Gold hub & black tyre <input type="checkbox"/> Green hub & black tyre <input type="checkbox"/> Blue hub & black tyre	<input type="checkbox"/> Purple hub & black tyre	
125mm (5")			
<input type="checkbox"/> XC070	Soft roll 5"x1.3" <i>(Black only)</i>	<input type="checkbox"/> XC120 \$ 229.00	Aluminium centre 5"x1" <i>(Silver hub and black urethane tyre only)</i>
<input type="checkbox"/> XC100 \$ 244.00	Pneumatic Aluminium centre 5"x1" <i>(Grey only)</i>	<input type="checkbox"/> XC140 \$ 229.00	Aluminium centre 5"x1.4" <i>(Silver hub and black urethane tyre only)</i>
150mm (6")			
<input type="checkbox"/> XC080	Soft roll 6"x1.3"	<input type="checkbox"/> XC145 \$ 305.00	Aluminium centre 6"x1.4" <i>(Silver hub and black urethane tyre only)</i>
Castor Forks			
<input type="checkbox"/> XC192	Anti Flutter castor fork <i>(Standard when no option selected)</i>	<input type="checkbox"/> XC210 \$ 624.00	Froglegs suspension castor fork
<i>Note: Colour follows the accent</i>		<input type="checkbox"/> Black <input type="checkbox"/> Silver	
Castor Pin Width			
<input checked="" type="checkbox"/> XY330	Castor pin width		
<input type="checkbox"/>	Optimise measurements <i>(Minimum width for clear castor rotation and maximum wheelbase length)</i>		
Wheel Lock Options			
<input type="checkbox"/> XD020	Underseat Scissor	<input type="checkbox"/> XD050	Push to lock
<input type="checkbox"/> XD030 \$ 262.00	Compact scissor	<input type="checkbox"/> XD046 \$ 403.00	Out Front push to lock
<input type="checkbox"/> XD035 \$ 347.00	Compact scissor with lightweight fixing <i>(Only with fixed centre of gravity)</i>	<input type="checkbox"/> XD085 \$ 461.00	Eagle Brakes (Indicate colour)
<input type="checkbox"/> XD010	Omit wheel locks	<input type="checkbox"/> XD086 \$ 500.00	Eagle Brakes with L/W fixing (Indicate colour) <i>(Only with fixed centre of gravity)</i>
		<input type="checkbox"/> BLACK <input type="checkbox"/> PURPLE <input type="checkbox"/> RED <input type="checkbox"/> BLUE Black Std if no option selected	

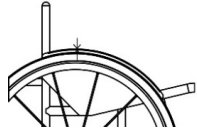
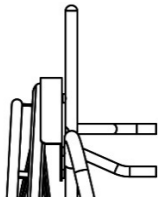
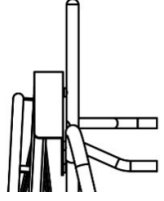
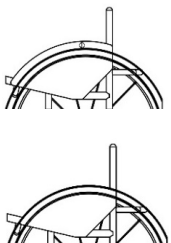
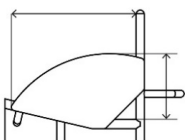
SIDEGUARDS AND ARMRESTS	
<div style="background-color: #eee; text-align: center; padding: 2px; margin-bottom: 5px;">Sideguard</div> <div style="background-color: #eee; text-align: center; padding: 2px; margin-bottom: 5px;">Aluminium Options</div> <p><input type="checkbox"/> XE030    Screw on aluminium \$322.00</p> <p><input type="checkbox"/> XE080    Lift out aluminium \$524.00</p> <p><input type="checkbox"/> XE180    Flip back aluminium \$387.00</p> <div style="background-color: #eee; text-align: center; padding: 2px; margin-bottom: 5px;">Carbon Fibre Options</div> <p><input type="checkbox"/> XE050    Screw on carbon fibre \$715.00</p> <p><input type="checkbox"/> XE100    Lift out carbon fibre \$755.00</p> <p><input type="checkbox"/> XE200    Flip back carbon fibre \$591.00</p> <div style="background-color: #eee; text-align: center; padding: 2px; margin-bottom: 5px;">ABS Plastic Options</div> <p><input type="checkbox"/> XE070    Screw on ABS plastic \$165.00</p> <p><input type="checkbox"/> XE120    Lift out ABS plastic \$480.00</p> <div style="background-color: #eee; text-align: center; padding: 2px; margin-bottom: 5px;">Welded Options</div> <p><input type="checkbox"/> TMLXE220    Welded with 6mm bead \$492.00</p>	<div style="background-color: #eee; text-align: center; padding: 2px; margin-bottom: 5px;">Sideguard with Fender</div> <div style="background-color: #eee; text-align: center; padding: 2px; margin-bottom: 5px;">Aluminium Options</div> <p><input type="checkbox"/> XE040    Screw on aluminium with fender \$ 275.00</p> <p><input type="checkbox"/> XE090    Lift out aluminium with fender \$ 570.00</p> <p><input type="checkbox"/> XE190    Flip back aluminium with fender \$ 329.00</p> <div style="background-color: #eee; text-align: center; padding: 2px; margin-bottom: 5px;">Carbon Fibre Options</div> <p><input type="checkbox"/> XE060    Screw on carbon fibre with fender \$ 938.00</p> <p><input type="checkbox"/> XE110    Lift out carbon fibre with fender \$ 1115.00</p> <p><input type="checkbox"/> XE210    Flip back carbon fibre with fender \$ 735.00</p> <div style="background-color: #eee; text-align: center; padding: 2px; margin-bottom: 5px;">Sideguard Measurements</div> <div style="background-color: #eee; text-align: center; padding: 2px; margin-bottom: 5px;">Fender height</div> <p><input type="checkbox"/> 10mm above tyre <i>(Standard)</i></p> <p><input type="checkbox"/> Individual above tyre <i>(Min = 10mm)</i></p> <p><input type="checkbox"/> <input style="width: 80px; height: 20px; border: 1px solid black;" type="text"/> mm</p>  <div style="background-color: #eee; text-align: center; padding: 2px; margin-bottom: 5px;">Fender position</div> <p><input type="checkbox"/> Centre of tyre <i>(Standard if no option selected)</i></p>  <p><input type="checkbox"/> Outside of tyre</p>  <div style="background-color: #eee; text-align: center; padding: 2px; margin-bottom: 5px;">Armrest Options</div> <p><input type="checkbox"/> XF010    Lift out armrest with plastic sideguard \$ 583.00 <i>(Indicate fixed height)</i></p> <p><input type="checkbox"/> XF020    Lift out armrest with Aluminium sideguard \$ 460.00 <i>(Indicate fixed height)</i></p> <p style="text-align: center;"><i>Height (Top of seatrail to top of armrest)</i></p> <p><input type="checkbox"/> <input style="width: 80px; height: 20px; border: 1px solid black;" type="text"/> mm</p>
<div style="background-color: #eee; text-align: center; padding: 2px; margin-bottom: 5px;">Sideguard Measurements</div> <div style="background-color: #eee; text-align: center; padding: 2px; margin-bottom: 5px;">Optimised measurements</div> <p><input type="checkbox"/> 25mm above tyre <i>(Follow tyre)</i></p> <p><input type="checkbox"/> Individual above tyre <i>(Follow tyre)</i></p> <p><input type="checkbox"/> <input style="width: 80px; height: 20px; border: 1px solid black;" type="text"/> mm</p> <p><input type="checkbox"/> Level with tyre <i>(Follow tyre)</i></p>  <div style="background-color: #eee; text-align: center; padding: 2px; margin-bottom: 5px;">Individual measurements</div> <p><input type="checkbox"/> Sideguard length</p> <p><input type="checkbox"/> <input style="width: 80px; height: 20px; border: 1px solid black;" type="text"/> mm</p> <p><input type="checkbox"/> Sideguard height</p> <p><input type="checkbox"/> <input style="width: 80px; height: 20px; border: 1px solid black;" type="text"/> mm</p> 	

BACKREST	
Backrest Height	
<input type="checkbox"/> XY230 Backrest height fixed Specify height <input style="width: 100px;" type="text"/> mm 	<input type="checkbox"/> XY245 Backrest height adjustable \$ 244.00 (+/-25mm) Specify height <input style="width: 100px;" type="text"/> mm 
Backrest Design	
<input type="checkbox"/> XG010 Fixed backrest (Non-folding)	<input type="checkbox"/> TMLXG020 Folding backrest with 2 position snap lock and angle adjust ( $\pm 5$ Deg)
Ergonomic Options	
<input checked="" type="checkbox"/> XY360 Backrest angle -5   -3   0   +3   +5 Individual <input style="width: 100px;" type="text"/> Deg (Max -10/+20 Deg) 	<input type="checkbox"/> XG100 Ergonomic backrest \$ 144.00 Vertical height <input style="width: 100px;" type="text"/> mm Rearward position <input style="width: 100px;" type="text"/> mm 
<input type="checkbox"/> XG110 Inward taper (inside of backrest posts) \$144.00 Specify width or per side <input style="width: 100px;" type="text"/> mm 	<input type="checkbox"/> XG120 Outward flare (inside of backrest posts) \$ 144.00 Specify width or per side <input style="width: 100px;" type="text"/> mm 
Push handle Options	
<input type="checkbox"/> XG070 Screw in push handles \$222.00 (N/A with XY245)	<input type="checkbox"/> XG090 Stroller push handles height adjustable \$ 434.00 Height from floor <input style="width: 100px;" type="text"/> mm <input type="checkbox"/> Optimise (1000mm from floor)
<input type="checkbox"/> XG080 Flip down push handles \$434.00 (N/A with XY245)	<input type="checkbox"/> XG097 Integrated push handle (Quickie design) \$ 666.00
<input type="checkbox"/> XG085 Flip down push handles height adjustable \$709.00 (N/A with XY245)	
Backrest Options	
<input type="checkbox"/> XG040 Heavy duty backrest upgrade (Recommended for hand cycling) (Not with XY245) \$204.00	<input type="checkbox"/> XG130 Extra deep brace bar (Recommended for JAY backs) (Std - 90mm) \$ 113.00 Depth <input style="width: 100px;" type="text"/> mm

CAMBER BAR	
Adjustable Centre of Gravity	
<input type="checkbox"/> XH110 Square back adjustable centre of gravity (25-150mm) (Open or closed frame) <input style="width: 100px;" type="text"/> mm 	<input type="checkbox"/> TMLXH090 V-style fixed centre of gravity <b>\$ 434.00</b> (25-125mm) (Open or closed frame) <input style="width: 100px;" type="text"/> mm 
<input type="checkbox"/> XH120 Round back adjustable centre of gravity (60-150mm) (Open or closed frame) <input style="width: 100px;" type="text"/> mm 	
Specify Camber Angle	
<input checked="" type="checkbox"/> XY390 Camber angle <input type="checkbox"/> 0 <input type="checkbox"/> 1 <input type="checkbox"/> 2 <input type="checkbox"/> 3 <input type="checkbox"/> 5	<input checked="" type="checkbox"/> XY390 Camber angle <input type="checkbox"/> 0 <input type="checkbox"/> 1 <input type="checkbox"/> 2 <input type="checkbox"/> 3 <input type="checkbox"/> 5
Camber Bar Options	
<input type="checkbox"/> XH030 Frog Legs suspension camber bar <b>\$ 841.00</b> <input type="checkbox"/> XH040 Handbike camber bar fixed <b>\$ 394.00</b> Camber angle (Handbike camber bar) <input type="checkbox"/> 0 <input type="checkbox"/> 5 Castor height from floor for handbike fitting (Standard 30mm if not indicated) <input type="checkbox"/> 30 <input type="checkbox"/> 50	<input type="checkbox"/> XH040 Handbike camber bar fixed <b>\$ 394.00</b> Camber angle (Handbike camber bar) <input type="checkbox"/> 0 <input type="checkbox"/> 5 Castor height from floor for handbike fitting (Standard 30mm if not indicated) <input type="checkbox"/> 30 <input type="checkbox"/> 50
Anti-Tip Options	
<input type="checkbox"/> XJ010 Swingaway anti tip LEFT side (Only with square back frame. Not with XH040) <b>\$ 165.00</b> <input type="checkbox"/> XJ020 Swingaway anti tip RIGHT side (Only with square back frame. Not with XH040) <b>\$ 165.00</b>	<input type="checkbox"/> XJ100 Single sport anti tip (centre mounted) <b>\$ 497.00</b>

REAR WHEELS			
Rear Wheel Size			
<input type="checkbox"/> XY420 24" Wheels	<input type="checkbox"/> XY430 25" Wheels		
Rear Wheel Gap			
<input type="checkbox"/> XY460 Rear wheel gap <div style="display: flex; justify-content: space-around; align-items: center;"> <div style="text-align: center;"> <input type="checkbox"/> 15  <input type="checkbox"/> 20  <input type="checkbox"/> 25  <small>Individual</small> </div> <div style="border: 1px solid black; width: 100px; height: 20px; margin: 0 auto;"></div> <div style="text-align: center;">   <small>mm</small> </div> </div>			
Wheel Options (Choose one)			
<input type="checkbox"/> XK010 Fusion 16 spoke <i>(Silver Hub, black spokes)</i>	<input type="checkbox"/> XK320 Spinerigy <b>XLX</b> 12 spoke \$ 1,051.00	<input type="checkbox"/> XK050 Spinerigy <b>LX</b> 12 spoke \$985.00	<input type="checkbox"/> XK060 Spinerigy <b>SPOX</b> 18 spoke \$ 655.00
<input type="checkbox"/> XK150 Spinerigy <b>CLX</b> 18 carbon blade spoke \$ 3,093.00 <b>N/A IN SILVER HUB</b>	<input type="checkbox"/> XK070 Spinerigy <b>BLXL</b> 18 blade spoke \$ 1,051.00 <b>N/A IN SILVER HUB</b>	<input type="checkbox"/> XK155 Spinerigy <b>CX6</b> 18 carbon blade spoke \$ 3,539.00 <b>N/A IN SILVER HUB</b>	
<b>Spinerigy Colour Options:</b>			
<input type="checkbox"/> Black spokes	<input type="checkbox"/> White spokes	<input type="checkbox"/> Yellow spokes	<input type="checkbox"/> XK180 Individual spoke design \$ 210.00 <i>(Specify colour)</i> Inside: _____ Outside: _____
<input type="checkbox"/> Red spokes	<input type="checkbox"/> Blue spokes	<input type="checkbox"/> Pink spokes	
<input type="checkbox"/> Purple spokes	<input type="checkbox"/> Orange spokes	<input type="checkbox"/> Green spokes	
<b>Spinerigy Anodise Options</b>			
<input type="checkbox"/> XK190 Black hub <i>(std option)</i>	<input type="checkbox"/> XK200 Silver hub \$125.00 <i>(n/a with BLXL/CLX)</i>	<input type="checkbox"/> XK201 Red hub/rims \$403.00 <i>(LX, XLX &amp; BLXL only)</i>	<input type="checkbox"/> XK205 Individual hub/rims \$60.00 Select colour: _____
<input type="checkbox"/> XK202 Purple hub/rims \$403.00 <i>(LX, XLX &amp; BLXL only)</i>	<input type="checkbox"/> XK203 Blue hub/rims \$403.00 <i>(LX, XLX &amp; BLXL only)</i>	<input type="checkbox"/> XK204 Gold hub/rims \$531.00 <i>(LX, XLX &amp; BLXL only)</i>	
Supply Without Wheels			
<input type="checkbox"/> XK040 Supply without Wheels	Wheel Type: <input style="width: 150px;" type="text"/>	Tyre Type: <input style="width: 150px;" type="text"/>	
Handrim Position / Options			
<input type="checkbox"/> XY480 Narrow set handrim	<input type="checkbox"/> XY485 Wide set handrim		
<input type="checkbox"/> XL090 Remove excess mounting tabs \$144.00 <i>(recommended for small wheel gaps)</i>			
Handrim Styles			
<input type="checkbox"/> XL010 Aluminium hard anodised 6 tab	<input type="checkbox"/> XL040 Titanium 6 tab \$ 439.00		
<input type="checkbox"/> XL160 Elipse 6 tab \$622.00 <i>(replacement for Surge)</i>	<input type="checkbox"/> XL035 Natural Fit LT \$ 732.00		
<input type="checkbox"/> XL020 Tetra grip 6 tab \$394.00	<input type="checkbox"/> XL150 Carbolife Gekko \$ 1,385.00	<input type="checkbox"/> Black	<input type="checkbox"/> Silver
<input type="checkbox"/> XL100 Para grip 6 tab \$394.00	<input type="checkbox"/> XL170 Carbolife Curve L (Black) \$ 1,372.00		
Tyre Options			
<input type="checkbox"/> XM010 Kenda <input type="checkbox"/> Grey <input type="checkbox"/> Blue <input type="checkbox"/> Red <small>(Std)</small>	<input type="checkbox"/> XM060 Schwalbe One \$ 131.00 <i>(24",25" only)</i>		
<input type="checkbox"/> XM130 Kenda black \$ 27.00	<input type="checkbox"/> XM050 Kenda K885 mountain bike tyre \$ 39.00 <i>(24",25" only)</i>		
<input type="checkbox"/> XM020 Schwalbe Marathon Plus \$ 97.00			
<input type="checkbox"/> XM040 Shox solid airless (Black) \$158.00			
Inner Tube Valve Options			
<input type="checkbox"/> XY500 Schraeder inner tube valve <i>(Standard if no option selected)</i>		<input type="checkbox"/> XY490 Presta inner tube valve	
Wheel Accessories			
<input type="checkbox"/> XK220 Titanium 130mm quick release axle pins (pair) <i>(N/A with XK010 &amp; XK070)</i> \$158.00	<input type="checkbox"/> XK300 Offroad wheel set 22" rim with handrim, MTB tyre and axle pins <i>(Replaces 24" wheel with XM010)</i> \$ 919.00		
<input type="checkbox"/> XK240 Quad release axle nuts (pair) \$237.00	<input type="checkbox"/> XK310 Offroad wheel set 24" rim with handrim, MTB tyre and axle pins <i>(Replaces 25" wheel with XM010)</i> \$ 919.00		



FINISH OPTIONS			
Frame & Component Finish			
<input type="checkbox"/> XN010 Powder coated frame	<input type="checkbox"/> XN150 Powder coated components <i>(Frame colour if not specified)</i>		
<b>Frame Comp. <u>Gloss</u></b> <input type="checkbox"/> <input type="checkbox"/> Black gloss 103 <input type="checkbox"/> <input type="checkbox"/> White gloss 100 <input type="checkbox"/> <input type="checkbox"/> Grey gloss 132 <input type="checkbox"/> <input type="checkbox"/> Cream gloss 135 <input type="checkbox"/> <input type="checkbox"/> Red gloss 108 <input type="checkbox"/> <input type="checkbox"/> Yellow gloss 120 <input type="checkbox"/> <input type="checkbox"/> Forest green gloss 143 <input type="checkbox"/> <input type="checkbox"/> Green gloss 107 <input type="checkbox"/> <input type="checkbox"/> Dark blue gloss 151 <input type="checkbox"/> <input type="checkbox"/> Royal blue gloss 154 <input type="checkbox"/> <input type="checkbox"/> Blue gloss 174 <input type="checkbox"/> <input type="checkbox"/> Duckegg blue gloss 141 <input type="checkbox"/> <input type="checkbox"/> Pink gloss 188 <input type="checkbox"/> <input type="checkbox"/> Orange gloss 180 <input type="checkbox"/> <input type="checkbox"/> Purple gloss 157 <input type="checkbox"/> TMLXN030 Bead blast frame \$ 557.00 <i>(All parts black unless XN165 chosen)</i> <input type="checkbox"/> TMLXN050 Polished frame \$ 1,146.00 <i>(All parts black unless XN170 chosen)</i>	<b>Frame Comp. <u>Matt</u></b> <input type="checkbox"/> <input type="checkbox"/> Black matt 105 <input type="checkbox"/> <input type="checkbox"/> White matt 101 <input type="checkbox"/> <input type="checkbox"/> Grey matt 131 <input type="checkbox"/> <input type="checkbox"/> Light grey matt 133 <input type="checkbox"/> <input type="checkbox"/> Navy blue matt 152	<b>Frame Comp. <u>Special</u></b> <input type="checkbox"/> <input type="checkbox"/> Chrome Mirror 300 <input type="checkbox"/> <input type="checkbox"/> Sparkle silver 170 <input type="checkbox"/> <input type="checkbox"/> Metallic black matt 104 <input type="checkbox"/> <input type="checkbox"/> Metallic grey matt 130 <input type="checkbox"/> <input type="checkbox"/> Black sandpaper 201 <input type="checkbox"/> <input type="checkbox"/> Grey sandpaper 202 <input type="checkbox"/> <input type="checkbox"/> White sandpaper 200	
<input type="checkbox"/> RGK-XN200 Individual paint colour -State Colour/RAL code \$ 557.00 _____ <div style="display: flex; justify-content: flex-end; align-items: center;"> <span style="margin-right: 10px;">Frame</span> <input type="checkbox"/> <span style="margin-right: 10px;">Comp</span> <input type="checkbox"/> </div>		<input type="checkbox"/> XN165 Bead blast components \$ 246.00 <input type="checkbox"/> XN170 Polished components \$ 210.00	
Accent Colour			
<b>Note:</b> Accent colour includes, forks, castor caps, decals.			
<input type="checkbox"/> Black accent <input type="checkbox"/> Red accent <input type="checkbox"/> Purple accent	<input type="checkbox"/> Silver accent <input type="checkbox"/> Blue accent	<input type="checkbox"/> RGK-XN250 Individual Accent Colour \$ 310.00 _____	
UPHOLSTERY			
Seat Upholstery			
<input type="checkbox"/> XP040 Seat sling adjustable tension with straps	<input type="checkbox"/> XR050 Carbon fibre seat plate \$ 473.00		
Backrest Upholstery			
<input type="checkbox"/> XP050 Airtech backrest strap adjustable	<input type="checkbox"/> XP070 Backrest upgrade to leather corners (Black) \$ 119.00 <i>(not with flip down push handles)</i>		
Backrest Stitching Options			
<input type="checkbox"/> Silver <input type="checkbox"/> Red	<input type="checkbox"/> Black <input type="checkbox"/> Orange	<input type="checkbox"/> Blue <input type="checkbox"/> Purple	<input type="checkbox"/> Individual: _____
RGK Logo Colour			
<input type="checkbox"/> White (Std) <input type="checkbox"/> Red	<input type="checkbox"/> Green <input type="checkbox"/> Orange	<input type="checkbox"/> Blue <input type="checkbox"/> Purple	<input type="checkbox"/> Individual: _____
Model Logo Colour			
<input type="checkbox"/> White (Std) <input type="checkbox"/> Red	<input type="checkbox"/> Green <input type="checkbox"/> Orange	<input type="checkbox"/> Blue <input type="checkbox"/> Purple	<input type="checkbox"/> Individual: _____
Backrest Accessories			
<input type="checkbox"/> XP110 Backrest with zip pocket \$ 125.00	<input type="checkbox"/> XP170 Individual backrest embroidery \$ 236.00 <i>PLEASE COMPLETE PAGE 11</i>		

CUSHION	
Cushion foam options	
<input type="checkbox"/> XP080	Cushion foam \$ 119.00 <i>(select density and size below)</i>
<input type="checkbox"/> Soft (CMS040)	<input type="checkbox"/> Medium (CMS050)
<input type="checkbox"/> 50mm	<input type="checkbox"/> 75mm <span style="margin-left: 100px;"><input type="checkbox"/> 100mm</span>
Cushion Cover Upgrades	
<input type="checkbox"/> XP085	Nylon cushion cover <i>(Black)</i>
<input type="checkbox"/> XP090	Air Lite cushion cover \$ 97.00 <i>(Black)</i>
<input type="checkbox"/> XP100	Leather cushion cover \$ 250.00 <i>(Black)</i>
Jay Products - PLEASE SUPPLY JAY ORDER FORM	
<input type="checkbox"/> JAY Cushion	<input type="checkbox"/> Jay Order form attached <i>(Price dependant on size / option)</i>
<input type="checkbox"/> JAY Backrest	<input type="checkbox"/> Jay Order form attached <i>(Price dependant on size / option)</i>
<input type="checkbox"/> JAY Whitmyer Headrest	<input type="checkbox"/> Jay Order form attached <i>(Price dependant on size / option)</i>
FRAME OPTIONS	
<input type="checkbox"/> XR060	Welded calf strap mounting loops \$ 152.00 <i>(To locate calf strap on front frame)</i>
	Specify height from floor <div style="border: 1px solid black; height: 20px; width: 100%;"></div>
<input type="checkbox"/>	<i>Optimise measurements</i>
	
ACCESSORIES	
<input type="checkbox"/> XR080	Frontwheel assembly \$1,037.00 <i>(Only with Tubular style footrest)</i>
<input type="checkbox"/> XP120	Frame protectors Neoprene zip fasten with TIGA logo \$ 83.00 <i>(Black)</i>
<input type="checkbox"/> XP420	Frame protectors Nylon velcro fasten \$ 80.00 <i>(Black)</i>
<input type="checkbox"/> XR010	Seat pouch velcro attach \$ 58.00 <i>(Black)</i>
<input type="checkbox"/> XR200	Rucksack with RGK logo \$ 149.00 <i>(Black)</i>
<input type="checkbox"/> XR020	Underseat large storage bag \$ 125.00 <i>(Black)</i>
<input checked="" type="checkbox"/> XR090	Tool kit
<input checked="" type="checkbox"/> XS060	Calf strap

