



Customer Contact Details

Customer Name: _____	Ship to Customer Address: <input type="checkbox"/>
Advisor: _____	Shipping Name: _____
Address: _____ _____ _____	Shipping Address: _____ _____ _____
Phone: _____	Phone: _____
Email: _____	Email: _____

Additional Information

Notes: _____ _____ _____ _____	Current Wheelchair: _____
	Customer Weight: _____
	Customer Height: _____
	Customer Disability: _____

Guide:

 Base product

 Required option

 Optional Extra

Critical Information



Information Needed

PRODUCT STYLE

 ELAXZ010 ELITE
\$7,520.00
 ELAXA062 Standard Frame

 ELAXA063 Standard Frame with 25mm seatrail

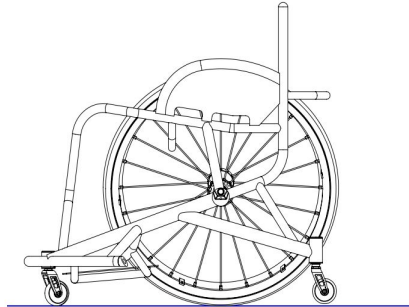
 ELAXA280 Heavy Duty Frame
 \$630.00 (Spinergy R10 wheels also required)

Max User Weight 125kg (275lbs)
 Yes, I am within the max user weight

CAD APPROVAL

 XW012 **QUOTE** CAD drawing for approval
 \$550 FLAT FEE (Includes two free revisions)

 XW010 **ORDER** CAD drawing for approval
 \$300 FLAT FEE (Includes two free revisions)

 XW009 **QUOTE** only no CAD
 \$0

 XW011 **ORDER** only no CAD
 \$0

KEY MEASUREMENTS

 XY010 Seat width (Inside to inside of sideguards)

 mm (Max - 500mm)

 XY020 Seat length

 mm (Max - 500mm)

 XY030 Extra seat length (Provides additional leg support & hand grip)

 mm

 XY050 Front frame height

 mm (Max - 630mm)
 (Min - 360mm)

 XY060 Rear frame height

 mm (Max - 630mm)
 (Min - 360mm)

 XY070 Frame length

 mm (Min = XY020 + XY030 + 140mm)

 XA020 Ergonomic seat
 \$119.00

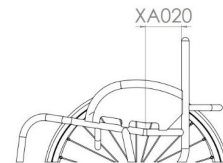
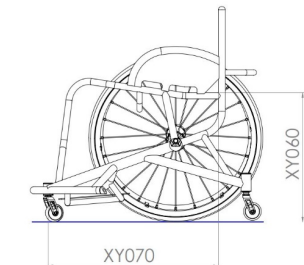
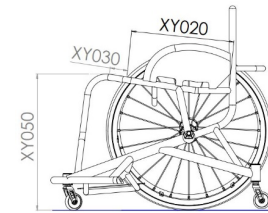
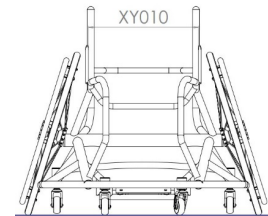
 Specify length
 mm (Standard = 120mm)

FRONT FRAME AND SEAT

Front Frame Options (Choose One)

XY080 Seat taper design

i Specify taper width
 mm

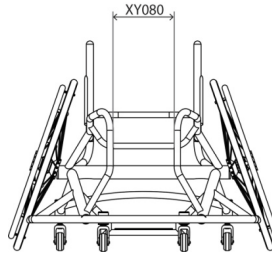

XA130 V-seat design
 \$302.00

i Specify taper width
 mm

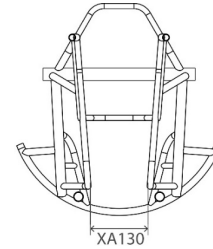

Advanced Front Frame Options

XY082 Seat taper position
 \$89.00

i Specify measurement
 mm

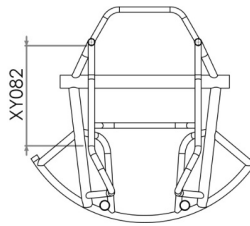

XA131 V-seat and taper design
 \$326.00

i Specify inside width at front of sideguard (A)
 mm

i Specify taper width (B)
 mm

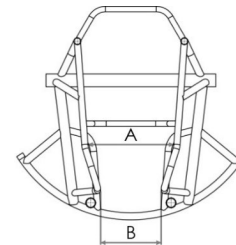

XA136 Parallel taper design
 \$89.00 (Not with Seat Taper XY080)

i Specify taper width
 mm

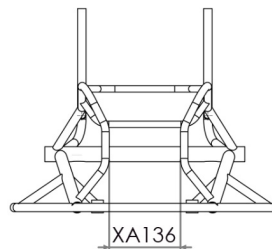

XA135 Asymmetrical taper design
 \$261.00

i Specify taper width (A)
 mm

i Specify offset (B)
 (Inside of sideguard to inside of taper width)
 mm

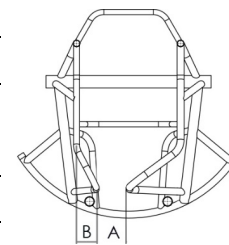

Seat Options

XR040 Aluminum seat plate
 \$190.00 (riveted to frame)

i Specify length of plate
 mm (Std XY020 - 20mm)

XA260 Drop seat design
 \$216.00 (only with either XR040 or 050)

i Specify drop
 mm (Std = 20mm)

XR050 Carbon fibre seat plate
 \$473.00 (riveted to frame)

i Specify length of plate
 mm (Std XY020 - 20mm)

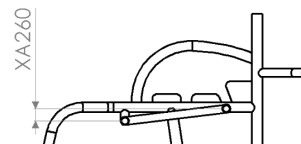

FOOTREST

Fixed Footrest	Adjustable Footrest
<input type="checkbox"/> ELAXB080 Fixed position footrest	<input type="checkbox"/> ELAXB130 Clamp on adjustable position footrest (\$302.00) (100mm range)
Height and Position	Height and Position
<input type="checkbox"/> Front footrest height <input type="text" value=""/> mm (min = 35mm)	<input type="checkbox"/> Front footrest height <input type="text" value=""/> mm (min = 40mm)
<input type="checkbox"/> Rear footrest height <input type="text" value=""/> mm (min = 35mm)	<input type="checkbox"/> Rear footrest height <input type="text" value=""/> mm (min = 40mm)
<input type="checkbox"/> Footrest position (front of footplate to castor pot) <input type="text" value=""/> mm	<input type="checkbox"/> Footrest position (front of footplate to castor pot) <input type="text" value=""/> mm
Footrest Size (Not ABS)	Footrest Size (Not ABS)
<input type="checkbox"/> Footrest width <input type="text" value=""/> mm (Std= 200mm)	<input type="checkbox"/> Footrest width <input type="text" value=""/> mm (Std= 200mm)
<input type="checkbox"/> Footrest length <input type="text" value=""/> mm (Std = 250mm)	<input type="checkbox"/> Footrest length <input type="text" value=""/> mm (Std = 250mm)
Footrest Plate	Footrest Plate
<input type="checkbox"/> XB180 Aluminium footplate (2.5mm)	<input type="checkbox"/> XB180 Aluminium footplate (5mm)
<input type="checkbox"/> XB190 Carbon fibre footplate \$552.00	<input type="checkbox"/> XB100 ABS moulded foot tray \$180.00
<input type="checkbox"/> XB100 ABS moulded foot tray \$180.00 Specify length <input type="text" value=""/> mm (Max = 380mm (Full) Std = 330mm)	<input type="checkbox"/> XB100 ABS moulded foot tray \$180.00 Specify length <input type="text" value=""/> mm (Max = 380mm (Full) Std = 330mm)
<input type="checkbox"/> ELAXB140 Spacer kit \$125.00 (Allows for 25mm increase in height)	
<input type="checkbox"/> ELAXB145 Multi position footrest tubes \$587.00	
Footrest Plate Options	
<input type="checkbox"/> XB240 Aluminium raised edges (Cost per Edge) \$185.00 <input type="checkbox"/> Front <input type="checkbox"/> Back <input type="checkbox"/> Left <input type="checkbox"/> Right Specify height <input type="text" value=""/> (Max = 60mm)	
Caster Pin Width	
<input checked="" type="checkbox"/> XY330 Caster pin width <input type="text" value=""/> mm <input type="checkbox"/> Optimise measurements	

CAMBER BAR, WING AND ANTI-TIP

Centre of Gravity

ELAXY510 Fixed centre of gravity

Specify measurement
 mm

(Note: dimension is taken from front of backrest to centre of axle)

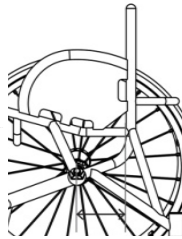

ELAXY515 Backrest COG adjustment (Not with welded sides) (+/-20mm)

Specify measurement
 mm

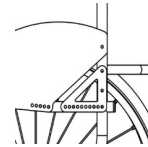

ELAXY560 Adjustable centre of gravity

Specify measurement
 mm

Specify Camber Angle

XY390 Camber angle

16 18 20 22

Wing Options

ELAXA110 Round design basketball wing

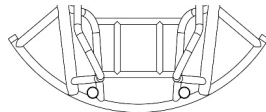

ELAXA125 Arrow design basketball wing \$256.00

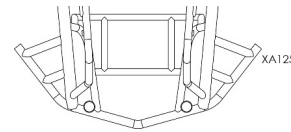

ELAXA120 Straight sided design basketball wing \$256.00

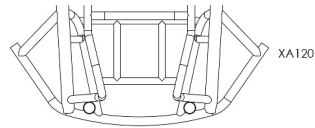

Anti-tip options

ELAXJ040 Single fixed anti tip

ELAXJ060 Double fixed anti tip \$354.00 (With high mount joining bar)

Specify caster pin width
 mm

Optimize measurements (Wide as possible - std if not indicated)

SIDEGUARDS

Sideguard Style

- | | | | |
|---|--|--|--|
| <input type="checkbox"/> ELAXE230
\$532.00 | Welded aluminium sport
<i>(Not with backrest COG Adj - ELAXY510)</i> | <input type="checkbox"/> XE030
\$322.00 | Screw on aluminium |
| <input type="checkbox"/> ELAXE250
\$250.00 | Welded aluminium tubes only
<i>(Not with backrest COG Adj - ELAXY510)</i> | <input type="checkbox"/> XE050
\$715.00 | Screw on carbon fibre
<i>(Not recommended for basketball use)</i> |
| <input type="checkbox"/> XE310
\$326.00 | High design upgrade
<i>(Only with option ELAXE230)</i> | | |

Sideguard Measurements

- | | | | |
|---|--|--|--|
| <input type="checkbox"/> Sideguard length | | <input type="checkbox"/> Follow Tire Design | |
| <input type="checkbox"/> Sideguard height (back) | | <input type="checkbox"/> 25mm above tire | |
| <input type="checkbox"/> Sideguard height (front)
<i>(optional for max height players)</i> | | <input type="checkbox"/> Individual above tire | |
| | | <input type="checkbox"/> Level with tire | |

Individual Shape

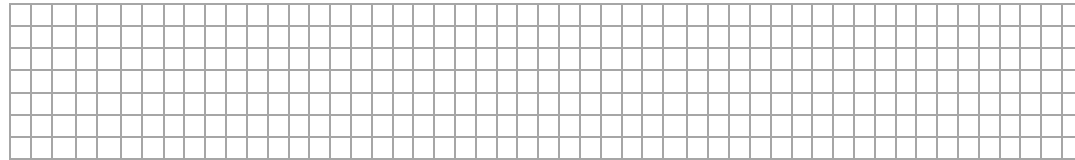

BACKREST

Backrest Height (Choose One)

- | | | | | |
|---|---------------------------------|--|--|--|
| <input type="checkbox"/> XY230
Fixed backrest height | | <input type="checkbox"/> XY245
\$244.00 | Adjustable backrest height
<i>(+/-25mm)</i> | |
| Specify height | <input type="text" value="mm"/> | Specify height | <input type="text" value="mm"/> | |

Ergonomic Options

- | | | | | |
|--|--|---|---|--|
| <input checked="" type="checkbox"/> XY360
Backrest angle | | <input type="checkbox"/> XG100
\$144.00 | Ergonomic backrest | |
| <input type="checkbox"/> -5 <input type="checkbox"/> -3 <input type="checkbox"/> 0 <input type="checkbox"/> +3 <input type="checkbox"/> +5 | <input type="text" value="Deg"/>
<i>(Max -10/+10 Deg)</i> | <input type="checkbox"/> XG120
\$144.00 | Outward flare
<i>(not with ELAXY245)</i> | |
| <input type="checkbox"/> XG110
\$144.00 | Inward taper
<i>(not with ELAXY245)</i> | <input type="checkbox"/> XG100
\$144.00 | Ergonomic backrest | |
| <input type="text" value="mm"/>
<i>Specify width or per side</i> | | <input type="text" value="mm"/>
<i>Specify width or per side</i> | Ergonomic backrest | |
| | | <input type="text" value="mm"/>
<i>Specify width or per side</i> | Ergonomic backrest | |

CASTORS AND REAR WHEELS

Castor Options

- | | |
|--|---|
| <input checked="" type="checkbox"/> XC160 Sport 61mm castor
(Black) | <input type="checkbox"/> XC181 Bones Reds bearings
(All castor bearings) |
| <input checked="" type="checkbox"/> XC200 Sport micro fork | <input type="checkbox"/> XC182 Bones Swiss Ceramic bearings
\$592.00 (All castor bearings) |

Rear Wheel Size

- | | | | |
|---|---|---|--|
| <input type="checkbox"/> XY420 24" Wheels | <input type="checkbox"/> XY430 25" Wheels | <input type="checkbox"/> XY440 26" Wheels | <input type="checkbox"/> XY450 700C Wheels |
|---|---|---|--|

Rear Wheel Gap

- | | |
|---|--|
| <input type="checkbox"/> XY460 Rear wheel gap | <input type="checkbox"/> XY470 Inside to inside of wheel |
|---|--|

15	20	25	30
<input type="checkbox"/>	<input type="checkbox"/>	<input type="checkbox"/>	<input type="checkbox"/>

Individual mm

XY460

OR

 mm

XY470

Rear Wheel Options

- | | |
|---|---|
| <input type="checkbox"/> XK030 Equalizer 36/48 spoke | <input type="checkbox"/> XK330 Spinergy SLX R10 heavy duty 24 spoke
\$1,832.00 (18 deg camber angle only) |
| <input type="checkbox"/> XK080 Spinergy SLX 24 spoke
\$991.00 | |

Spinergy Colour Options

- | | | | |
|--|--|--|---|
| <input type="checkbox"/> Black spokes | <input type="checkbox"/> White spokes | <input type="checkbox"/> Yellow spokes | <input type="checkbox"/> XK180 Individual spoke design
\$210.00 (Specify colour) |
| <input type="checkbox"/> Red spokes | <input type="checkbox"/> Blue spokes | <input type="checkbox"/> Pink spokes | Inside: _____ |
| <input type="checkbox"/> Purple spokes | <input type="checkbox"/> Orange spokes | <input type="checkbox"/> Green spokes | Outside: _____ |

Spinergy Anodize Options

- | | | | |
|---|--|--|---|
| <input type="checkbox"/> XK190 Black hub
NC (std option) | <input type="checkbox"/> XK200 Silver hub
\$125.00 | <input type="checkbox"/> XK201 Red hub/rims
\$403.00 | <input type="checkbox"/> XK205 Individual hub/rims
\$560.00 Select colour: _____ |
| <input type="checkbox"/> XK202 Purple hub/rims
\$403.00 | <input type="checkbox"/> XK203 Blue hub/rims
\$403.00 | <input type="checkbox"/> XK204 Gold hub/rims
\$531.00 | |

Supply Without Wheels

- | | | |
|--|--|---|
| <input type="checkbox"/> XK040 Supply without Wheels | Wheel Type: <input style="width: 150px;" type="text"/> | Tire Type: <input style="width: 150px;" type="text"/> |
|--|--|---|

Handrim Position / Options

- | | |
|---|--|
| <input type="checkbox"/> XY480 Narrow set handrim | <input type="checkbox"/> XY485 Wide set handrim |
| <input type="checkbox"/> XL090 Remove excess mounting tabs
\$144.00 (recommended for small wheel gaps) | <input type="checkbox"/> XL080 Super narrow set handrim
\$290.00 (only with XL040 and includes XL090) |

Handrim Style

- | | |
|---|---|
| <input type="checkbox"/> XL010 Aluminium hard anodized 6 tab | <input type="checkbox"/> XL040 Titanium 6 tab
\$439.00 (Not with 700C) |
| <input type="checkbox"/> XL070 Aluminium hard anodized 12 tab
\$144.00 (24" not available) | <input type="checkbox"/> XL050 Stainless steel 6 tab
\$244.00 |

Tire Options

- | | |
|--|--|
| <input type="checkbox"/> XM070 Kenda Kaliente <input type="checkbox"/> Red <input type="checkbox"/> Blue | <input type="checkbox"/> XM080 Tufo MS3 tubeless (Blue only)
\$80.00 |
| <input type="checkbox"/> XM150 IRC Exeracer Pro (Red Only)
\$185.00 | <input type="checkbox"/> XM090 Tufo WS3 tubeless (24" only and Blue only)
\$80.00 |

Spare Wheel

- | | |
|---|--|
| <input type="checkbox"/> ELAXK500 Spare wheel Spinergy
\$2,225.00 (All inclusive + axle pin) | <input type="checkbox"/> XK520 Spare wheel upcharge
\$625.00 (for Titanium or super narrow push rims) |
|---|--|

Inner Tube Valve Options

- | | |
|---|--|
| <input type="checkbox"/> XY500 Schraeder inner tube valve | <input type="checkbox"/> XY490 Presta inner tube valve
(Standard if no option selected) |
|---|--|

FINISH OPTIONS

Frame & Component finish

<input type="checkbox"/> XN010 Powder coated frame		<input type="checkbox"/> XN150 Powder coated components <i>(Frame colour if not specified)</i>																																																																																		
Gloss	Matt	Special																																																																																		
<table border="0"> <tr><td><input type="checkbox"/></td><td><input type="checkbox"/></td><td>Black gloss 103</td></tr> <tr><td><input type="checkbox"/></td><td><input type="checkbox"/></td><td>White gloss 100</td></tr> <tr><td><input type="checkbox"/></td><td><input type="checkbox"/></td><td>Grey gloss 132</td></tr> <tr><td><input type="checkbox"/></td><td><input type="checkbox"/></td><td>Cream gloss 135</td></tr> <tr><td><input type="checkbox"/></td><td><input type="checkbox"/></td><td>Red gloss 108</td></tr> <tr><td><input type="checkbox"/></td><td><input type="checkbox"/></td><td>Yellow gloss 120</td></tr> <tr><td><input type="checkbox"/></td><td><input type="checkbox"/></td><td>Forest green gloss 143</td></tr> <tr><td><input type="checkbox"/></td><td><input type="checkbox"/></td><td>Green gloss 107</td></tr> <tr><td><input type="checkbox"/></td><td><input type="checkbox"/></td><td>Dark blue gloss 151</td></tr> <tr><td><input type="checkbox"/></td><td><input type="checkbox"/></td><td>Royal blue gloss 154</td></tr> <tr><td><input type="checkbox"/></td><td><input type="checkbox"/></td><td>Blue gloss 174</td></tr> <tr><td><input type="checkbox"/></td><td><input type="checkbox"/></td><td>Duckegg blue gloss 141</td></tr> <tr><td><input type="checkbox"/></td><td><input type="checkbox"/></td><td>Pink gloss 188</td></tr> <tr><td><input type="checkbox"/></td><td><input type="checkbox"/></td><td>Orange gloss 180</td></tr> <tr><td><input type="checkbox"/></td><td><input type="checkbox"/></td><td>Purple gloss 157</td></tr> </table>	<input type="checkbox"/>	<input type="checkbox"/>	Black gloss 103	<input type="checkbox"/>	<input type="checkbox"/>	White gloss 100	<input type="checkbox"/>	<input type="checkbox"/>	Grey gloss 132	<input type="checkbox"/>	<input type="checkbox"/>	Cream gloss 135	<input type="checkbox"/>	<input type="checkbox"/>	Red gloss 108	<input type="checkbox"/>	<input type="checkbox"/>	Yellow gloss 120	<input type="checkbox"/>	<input type="checkbox"/>	Forest green gloss 143	<input type="checkbox"/>	<input type="checkbox"/>	Green gloss 107	<input type="checkbox"/>	<input type="checkbox"/>	Dark blue gloss 151	<input type="checkbox"/>	<input type="checkbox"/>	Royal blue gloss 154	<input type="checkbox"/>	<input type="checkbox"/>	Blue gloss 174	<input type="checkbox"/>	<input type="checkbox"/>	Duckegg blue gloss 141	<input type="checkbox"/>	<input type="checkbox"/>	Pink gloss 188	<input type="checkbox"/>	<input type="checkbox"/>	Orange gloss 180	<input type="checkbox"/>	<input type="checkbox"/>	Purple gloss 157	<table border="0"> <tr><td><input type="checkbox"/></td><td><input type="checkbox"/></td><td>Black matt 105</td></tr> <tr><td><input type="checkbox"/></td><td><input type="checkbox"/></td><td>White matt 101</td></tr> <tr><td><input type="checkbox"/></td><td><input type="checkbox"/></td><td>Grey matt 131</td></tr> <tr><td><input type="checkbox"/></td><td><input type="checkbox"/></td><td>Light grey matt 133</td></tr> <tr><td><input type="checkbox"/></td><td><input type="checkbox"/></td><td>Navy blue matt 152</td></tr> </table>	<input type="checkbox"/>	<input type="checkbox"/>	Black matt 105	<input type="checkbox"/>	<input type="checkbox"/>	White matt 101	<input type="checkbox"/>	<input type="checkbox"/>	Grey matt 131	<input type="checkbox"/>	<input type="checkbox"/>	Light grey matt 133	<input type="checkbox"/>	<input type="checkbox"/>	Navy blue matt 152	<table border="0"> <tr><td><input type="checkbox"/></td><td><input type="checkbox"/></td><td>Chrome Mirror 300</td></tr> <tr><td><input type="checkbox"/></td><td><input type="checkbox"/></td><td>Sparkle silver 170</td></tr> <tr><td><input type="checkbox"/></td><td><input type="checkbox"/></td><td>Metallic black matt 104</td></tr> <tr><td><input type="checkbox"/></td><td><input type="checkbox"/></td><td>Metallic grey matt 130</td></tr> <tr><td><input type="checkbox"/></td><td><input type="checkbox"/></td><td>Black sandpaper 201</td></tr> <tr><td><input type="checkbox"/></td><td><input type="checkbox"/></td><td>Grey sandpaper 202</td></tr> <tr><td><input type="checkbox"/></td><td><input type="checkbox"/></td><td>White sandpaper 200</td></tr> </table>		<input type="checkbox"/>	<input type="checkbox"/>	Chrome Mirror 300	<input type="checkbox"/>	<input type="checkbox"/>	Sparkle silver 170	<input type="checkbox"/>	<input type="checkbox"/>	Metallic black matt 104	<input type="checkbox"/>	<input type="checkbox"/>	Metallic grey matt 130	<input type="checkbox"/>	<input type="checkbox"/>	Black sandpaper 201	<input type="checkbox"/>	<input type="checkbox"/>	Grey sandpaper 202	<input type="checkbox"/>	<input type="checkbox"/>	White sandpaper 200
<input type="checkbox"/>	<input type="checkbox"/>	Black gloss 103																																																																																		
<input type="checkbox"/>	<input type="checkbox"/>	White gloss 100																																																																																		
<input type="checkbox"/>	<input type="checkbox"/>	Grey gloss 132																																																																																		
<input type="checkbox"/>	<input type="checkbox"/>	Cream gloss 135																																																																																		
<input type="checkbox"/>	<input type="checkbox"/>	Red gloss 108																																																																																		
<input type="checkbox"/>	<input type="checkbox"/>	Yellow gloss 120																																																																																		
<input type="checkbox"/>	<input type="checkbox"/>	Forest green gloss 143																																																																																		
<input type="checkbox"/>	<input type="checkbox"/>	Green gloss 107																																																																																		
<input type="checkbox"/>	<input type="checkbox"/>	Dark blue gloss 151																																																																																		
<input type="checkbox"/>	<input type="checkbox"/>	Royal blue gloss 154																																																																																		
<input type="checkbox"/>	<input type="checkbox"/>	Blue gloss 174																																																																																		
<input type="checkbox"/>	<input type="checkbox"/>	Duckegg blue gloss 141																																																																																		
<input type="checkbox"/>	<input type="checkbox"/>	Pink gloss 188																																																																																		
<input type="checkbox"/>	<input type="checkbox"/>	Orange gloss 180																																																																																		
<input type="checkbox"/>	<input type="checkbox"/>	Purple gloss 157																																																																																		
<input type="checkbox"/>	<input type="checkbox"/>	Black matt 105																																																																																		
<input type="checkbox"/>	<input type="checkbox"/>	White matt 101																																																																																		
<input type="checkbox"/>	<input type="checkbox"/>	Grey matt 131																																																																																		
<input type="checkbox"/>	<input type="checkbox"/>	Light grey matt 133																																																																																		
<input type="checkbox"/>	<input type="checkbox"/>	Navy blue matt 152																																																																																		
<input type="checkbox"/>	<input type="checkbox"/>	Chrome Mirror 300																																																																																		
<input type="checkbox"/>	<input type="checkbox"/>	Sparkle silver 170																																																																																		
<input type="checkbox"/>	<input type="checkbox"/>	Metallic black matt 104																																																																																		
<input type="checkbox"/>	<input type="checkbox"/>	Metallic grey matt 130																																																																																		
<input type="checkbox"/>	<input type="checkbox"/>	Black sandpaper 201																																																																																		
<input type="checkbox"/>	<input type="checkbox"/>	Grey sandpaper 202																																																																																		
<input type="checkbox"/>	<input type="checkbox"/>	White sandpaper 200																																																																																		
<input type="checkbox"/> ELAXN030 Brushed frame \$557.00 <i>(All parts black unless XN160 chosen)</i>		<input type="checkbox"/> XN160 Brushed components \$119.00 <i>(not required with fixed footrest & backrest)</i>																																																																																		
<input type="checkbox"/> ELAXN050 Polished frame \$655.00 <i>(All parts black unless XN170 chosen)</i>		<input type="checkbox"/> XN170 Polished components \$210.00 <i>(not required with fixed footrest & backrest)</i>																																																																																		
<input type="checkbox"/> RGK-XN200 Individual paint colour (State Colour/RAL code) \$557.00																																																																																				
<table border="0"> <tr> <td>Frame</td> <td>Comp</td> <td><input type="checkbox"/></td> <td><input type="checkbox"/></td> </tr> </table>				Frame	Comp	<input type="checkbox"/>	<input type="checkbox"/>																																																																													
Frame	Comp	<input type="checkbox"/>	<input type="checkbox"/>																																																																																	

Accent Colour

Note: Accent colour includes, forks, castor caps, decals.

<input type="checkbox"/> Black accent	<input type="checkbox"/> Silver accent	<input type="checkbox"/> RGK-XN250 Individual accent \$310.00 Select Colour: <input type="text"/>
<input type="checkbox"/> Red accent	<input type="checkbox"/> Blue accent	
<input type="checkbox"/> Purple accent		

UPHOLSTERY (N/A WITH CX SEAT)

Seat Upholstery

XP040 Seat sling strap adjustable
(Not required with seat plate)

Backrest Upholstery

<input checked="" type="checkbox"/> XP055 Airtech sport backrest strap adjustable (BLK)	<input type="checkbox"/> XP070 Backrest upgrade to leather corners \$119.00 <i>(Black)</i>
---	--

Backrest Stitching Options

<input type="checkbox"/> Silver	<input type="checkbox"/> Black	<input type="checkbox"/> Blue	<input type="checkbox"/> Individual: _____
<input type="checkbox"/> Red	<input type="checkbox"/> Light blue	<input type="checkbox"/> Purple	

Backrest RGK Logo Colour

<input type="checkbox"/> White (Std)	<input type="checkbox"/> Green	<input type="checkbox"/> Blue	<input type="checkbox"/> Individual: _____
<input type="checkbox"/> Red	<input type="checkbox"/> Light blue	<input type="checkbox"/> Purple	

Backrest Accessories

XP170 Individual backrest embroidery
\$236.00
(Please provide .jpeg file and positioning)

CUSHION	
Cushion Foam Options	
<input type="checkbox"/> XP080 Cushion foam \$119.00 <i>(select density and size below)</i>	<input type="checkbox"/> Soft (CMS040) <input type="checkbox"/> Medium (CMS050) <input type="checkbox"/> Hard (9lb recon) <input type="checkbox"/> 50mm <input type="checkbox"/> 75mm <input type="checkbox"/> 100mm <input type="checkbox"/> Other <input style="width: 50px;" type="text"/> mm
<input type="checkbox"/> XP340 Plastazote cushion upgrade \$113.00 <i>(Indicate max height)</i>	
Cushion Cover Options	
<input type="checkbox"/> XP081 Nylon cushion cover <i>(Black)</i>	
<input type="checkbox"/> XP090 Air Lite cushion cover <i>(Black)</i> \$97.00	<input type="checkbox"/> XP380 Neoprene cushion cover <i>(Black)</i> \$125.00
STRAPS	
Velcro straps	
<input type="checkbox"/> XS050 100mm Pro adjustable velcro strap \$170.00	<input type="checkbox"/> XS020 Sport ratchet strap (Click strap) \$138.00 <i>(11" x 2" pad)</i>
<input type="checkbox"/> XS055 50mm Pro adjustable velcro strap \$133.00	<input type="checkbox"/> XS025 Pelvi Loc 2DA ratchet strap \$400.00 <i>(For thighs and knees)</i>
<input type="checkbox"/> XS057 50mm Pro knee strap \$246.00 <i>(measurement from tube to tube over knees)</i>	Select size: <input type="checkbox"/> Medium (8") <input type="checkbox"/> Large (10")
Velcro strap position	
<input type="checkbox"/> Strap 1 <input style="width: 100px;" type="text"/> Type	
 Specify strap length <input style="width: 80px;" type="text"/> mm	 Specify distance from back post <input style="width: 80px;" type="text"/> mm
<input type="checkbox"/> Strap 1 <input style="width: 100px;" type="text"/> Type	
 Specify strap length <input style="width: 80px;" type="text"/> mm	 Specify distance from back post <input style="width: 80px;" type="text"/> mm
<input type="checkbox"/> XS030 Pelvi Loc 3DA ratchet strap \$413.00 <i>(For hips)</i>	
Select size: <input type="checkbox"/> Small (8") <input type="checkbox"/> Medium (9") <input type="checkbox"/> Large (10") <input type="checkbox"/> Extra Large (11")	
<input type="checkbox"/> XS035 M2 ratchet strap \$279.00 <i>(For thighs and knees)</i>	
Select size: <input type="checkbox"/> 8" <input type="checkbox"/> 10" <input type="checkbox"/> 12"	
<input type="checkbox"/> Strap 1 <input style="width: 100px;" type="text"/> Type	
 Specify distance from back post <input style="width: 80px;" type="text"/> mm	<input type="checkbox"/> Strap 2 <input style="width: 100px;" type="text"/> Type
<input style="width: 100px;" type="text"/> mm	
<input type="checkbox"/> XS040 Fixed mounting points \$158.00 <i>(one set per click strap)</i>	
<input type="checkbox"/> x1 <input type="checkbox"/> x2 <input type="checkbox"/> x3	
<input type="checkbox"/> XS045 Clamped mounting points \$95.00 <i>(one set per click strap)</i>	
<input type="checkbox"/> x1 <input type="checkbox"/> x2 <input type="checkbox"/> x3	
FRAME OPTIONS	
<input type="checkbox"/> XR060 Calf strap mounting loops \$148.00	<input type="checkbox"/> XR065 Strap location loops \$113.00
ACCESSORIES	
<input type="checkbox"/> XR030 Triple wheel bag <i>(Black)</i> \$198.00	<input type="checkbox"/> XS070 Foot strap <i>(select if required)</i>
<input type="checkbox"/> XP130 Frame protectors full length \$125.00	<input type="checkbox"/> XS060 Calf strap <i>(select if required)</i>
<input type="checkbox"/> XS100 Bodypoint waist strap \$101.00	<input type="checkbox"/> XP400 Back bar protector
<input type="checkbox"/> Small <input type="checkbox"/> Large	<input type="checkbox"/> XR090 Tool kit

ELITE

SERIAL NO: _____

PROD DATE: ____ / ____

