

**AI**  
ALUMINIUM 7020



**Customer Contact Details**

Customer Name: \_\_\_\_\_

Advisor: \_\_\_\_\_

Address: \_\_\_\_\_

\_\_\_\_\_

\_\_\_\_\_

Phone: \_\_\_\_\_

Email: \_\_\_\_\_

Shipping Name: \_\_\_\_\_

Address: \_\_\_\_\_

\_\_\_\_\_

\_\_\_\_\_

Phone: \_\_\_\_\_

Email: \_\_\_\_\_

**Additional Information**

Notes: \_\_\_\_\_

\_\_\_\_\_

\_\_\_\_\_

\_\_\_\_\_

Current Wheelchair: \_\_\_\_\_

Customer Weight: \_\_\_\_\_

Customer Height: \_\_\_\_\_

Customer Disability: \_\_\_\_\_

Guide:

Base product

Required option

Optional Extra



Critical Information



Information Needed

## PRODUCT STYLE

**GXAX2010 GRAND SLAM X**  
\$11,492.00

Max User Weight 125kg (275lbs)

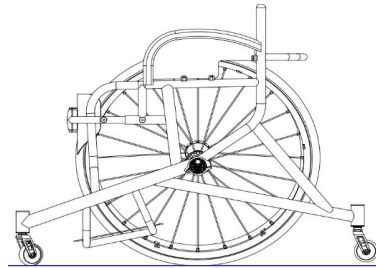

## CAD APPROVAL

XW012 QUOTE CAD drawing for approval  
\$550 FLAT FEE (includes two free revisions)

XW010 ORDER CAD drawing for approval  
\$300 FLAT FEE (includes two free revisions)

XW009 QUOTE only no CAD \$0

XW011 ORDER only no CAD \$0

## KEY MEASUREMENTS

XY010 Seat width (Inside to inside of sideguards)

 mm

(Max - 500mm)

XY020 Seat length

 mm

(Max - 500mm)

XY030 Extra seat length (not required with Knee support)

 mm

XY050 Front frame height

 mm

(Max - 630mm)  
(Min - 360mm)

XY060 Rear frame height

 mm

(Max - 630mm)  
(Min - 360mm)

XY070 Frame length

 mm

(Min XY020 + XY030 + 110mm)

XA020 Ergonomic seat  
\$121.00



Specify length  
 mm

(Standard = 120mm)

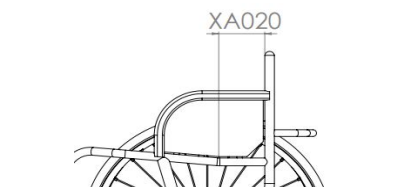
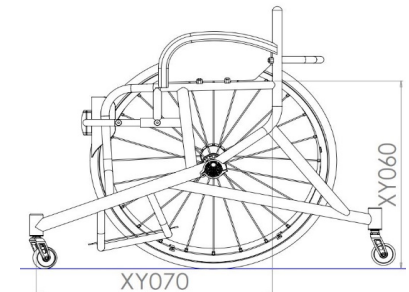
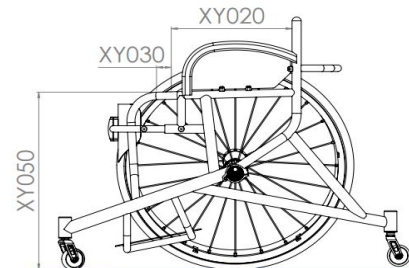
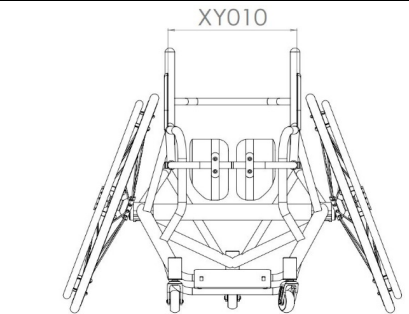

**FRAME OPTIONS**

Front Frame Options (Choose One)

XY080 Seat taper design

**i** Specify taper width  mm

(Optional, to provide additional leg support / positioning)

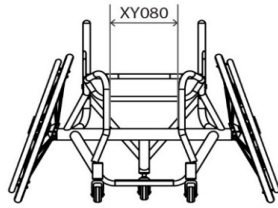

XA130 V-seat design

\$307.00

**i** Specify taper width  mm

(Same measurement as XY080)

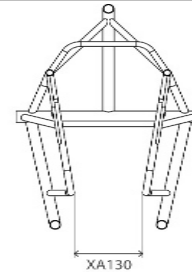

XA136 Frame front seat parallel design  
\$90.00

**i** Specify width  mm

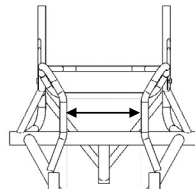

XA131 V-seat and seat taper design  
\$331.00

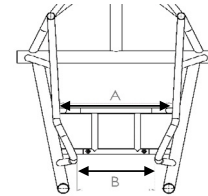

Knee Support Options

XA200 Knee support ratchet system  
(Tubes on the outside as std)

**i** Specify length  mm

Optimize (Smallest)

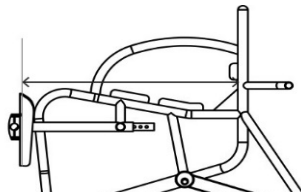

XA202 Plastic shin pads  
(Includes 5mm padding)

XA203 Carbon fibre shin pads  
\$740.00  
(Includes 7mm hard padding)

XA204 Extra padding for shin pads  
\$181.00

**i** Specify padding thickness  mm

Specify padding density

Medium  Hard

Seat Options

XR040 Aluminum seat plate (riveted to frame)  
\$193.00

**i** Specify length of plate  mm (Std XY020 20mm)

XR050 Carbon fibre seat plate (riveted to frame)  
\$480.00

**i** Specify length of plate  mm (Std XY020 20mm)

**FOOTREST**

Footrest Type

GXAXB080 Fixed position footrest

Footrest Measurements

Front footrest height

mm (min = 35mm)

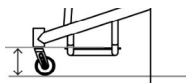

Footrest width

mm (Std= 200mm)

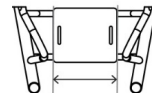

Rear footrest height

mm (min = 35mm)

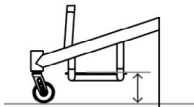

Footrest length

mm (Std = 250mm)

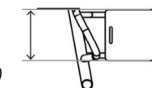

Footrest position  
(front of footplate to caster pot)

mm

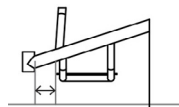

Footrest Plate

XB180 Aluminium footplate  
(2.5mm)

GXAXB140 Spacer kit  
\$83.00 (Allows for 25mm increase in height)

XB190 Carbon fibre footplate  
\$560.00

XB100 ABS moulded foot tray  
\$183.00

Specify length

mm (Max = 380mm (Full)  
Std = 330mm)

Footrest Plate Options

XB240 Aluminium raised edges  
\$188.00 (Cost per Edge)

Front  Back  Left  Right

Specify height

(Max = 60mm)

Caster Pin Width

XY330 Caster pin width

mm

Optimize measurements

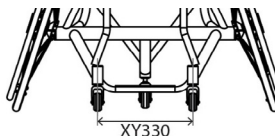

## CAMBER BAR, WING AND ANTI-TIP

### Centre of Gravity

GXAXY510 Fixed centre of gravity

Specify measurement

mm

(Note: dimension is taken from front of backrest post to centre of axle)

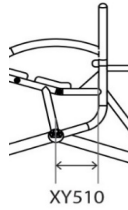

### Camber Angle & Anti Tip

XY390 Camber angle

16  18  20  22

GXAXJ040 Single fixed anti tip



Specify distance behind rear wheel

mm (Std = 100mm)

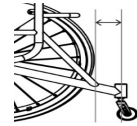

## SIDEGUARDS

### Sideguard Style

GXAXE240 Welded aluminium sport

\$1,739.00

GXAXE230 Welded aluminium sport with Carbon Fibre

\$1,883.00

XE030 Screw on aluminium

\$327.00

\$322.00

XE050 Screw on carbon fibre

\$726.00

\$715.00

### Sideguard Measurements

Sideguard length

mm

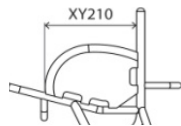

Sideguard height

mm

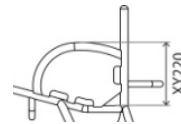

25mm above tire (Follow tire)

Individual above tire (Follow tire)

mm

Level with tire (Follow tire)

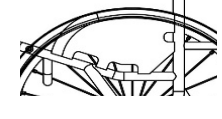
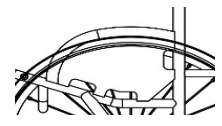

## BACKREST

### Backrest Height (Choose One)

XY230 Fixed backrest height

Specify height

mm

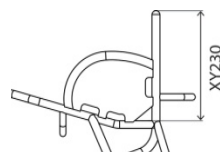

XY245 Adjustable backrest height (+/- 25mm)

\$244.00

Specify height

mm

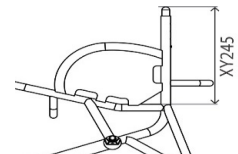

### Ergonomic Options

XY360 Backrest angle

-5  -3  0  +3  +5

Individual  Deg (Max -10/+10 Deg)

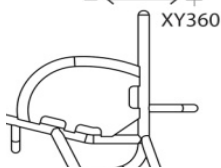

XG100 Ergonomic backrest

\$146.00

Vertical height  mm

Rearward position  mm

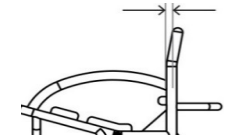
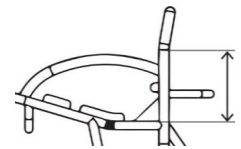

XG110 Inward taper (inside of backrest posts)

\$146.00

Specify width / per side mm

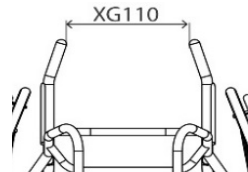

XG120 Outward flare (inside of backrest posts)

\$146.00

Specify width / per side mm

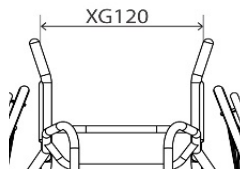

**CASTERS AND REAR WHEELS**

**Caster Options**

- |  |   |
|--|---|
| <input type="checkbox"/> XC160 Sport 61mm caster<br><i>(Std, Black)</i>        | <input type="checkbox"/> XC181 Bones Reds bearings<br><i>(All caster bearings)</i>                      |
| <input type="checkbox"/> XC170 Sport 72mm caster<br>\$200.00<br><i>(Black)</i> | <input type="checkbox"/> XC182 Bones Swiss Ceramic bearings<br>\$601.00<br><i>(All caster bearings)</i> |

**Rear Wheel Size**

- |   |   |   |  |
|---|---|---|--|
| <input type="checkbox"/> XY420 24" Wheels | <input type="checkbox"/> XY430 25" Wheels | <input type="checkbox"/> XY440 26" Wheels | <input type="checkbox"/> XY450 700C Wheels |
|---|---|---|--|

**Rear Wheel Gap**

<input type="checkbox"/> XY460 Rear wheel gap	<input type="checkbox"/> XY470 Inside to inside of wheel
<p>Individual <input type="text" value=""/> mm</p>	<p>OR <input type="text" value=""/> mm</p>

**Rear Wheel Options**

- |  |  |
|--|--|
| <input type="checkbox"/> XK080 Spinerigy SLX 24 spoke<br>\$1006.00 | <input type="checkbox"/> XK100 Spinerigy XSLX 24 spoke<br>\$1,060.00 |
|--|--|

**Spinerigy Colour Options:**



- |  |  |  |   |
|--|--|--|---|
| <input type="checkbox"/> Black spokes  | <input type="checkbox"/> White spokes  | <input type="checkbox"/> Yellow spokes | <input type="checkbox"/> XK180 Individual spoke design<br>\$213.00<br><i>(Specify colour)</i> |
| <input type="checkbox"/> Red spokes    | <input type="checkbox"/> Blue spokes   | <input type="checkbox"/> Pink spokes   | <i>Inside:</i> _____  |
| <input type="checkbox"/> Purple spokes | <input type="checkbox"/> Orange spokes | <input type="checkbox"/> Green spokes  | <i>Outside:</i> _____   |

**Spinerigy Anodise Options**

- |   |  |  |  |
|---|--|--|--|
| <input type="checkbox"/> XK190 Black hub<br>NC<br><i>(std option)</i> | <input type="checkbox"/> XK200 Silver hub<br>\$127.00    | <input type="checkbox"/> XK201 Red hub/rims<br>\$409.00  | <input type="checkbox"/> XK205 Individual hub/rims<br>\$568.00<br>Select colour: _____ |
| <input type="checkbox"/> XK202 Purple hub/rims<br>\$409.00            | <input type="checkbox"/> XK203 Blue hub/rims<br>\$409.00 | <input type="checkbox"/> XK204 Gold hub/rims<br>\$539.00 |  |

**Supply Without Wheels**

- |  |  |   |
|--|--|---|
| <input type="checkbox"/> XK040 Supply without Wheels | <input type="text" value="Wheel Type:"/> | <input type="text" value="Tire Type:"/> |
|--|--|---|

**Handrim Position / Options**

- |   |  |
|---|--|
| <input type="checkbox"/> XY480 Narrow set handrim   | <input type="checkbox"/> XY485 Wide set handrim  |
| <input type="checkbox"/> XL090 Remove excess mounting tabs<br>\$146.00<br><i>(recommended for small wheel gaps)</i> | <input type="checkbox"/> XL080 Super narrow set handrim<br>\$294.00<br><i>(only with XL040 and includes XL090)</i> |

**Handrim Style**

- |   |   |
|---|---|
| <input type="checkbox"/> XL010 Aluminium hard anodized 6 tab  | <input type="checkbox"/> XL040 Titanium 6 tab<br>\$446.00<br><i>(700C not available)</i>  |
| <input type="checkbox"/> XL130 Aluminium hard anodized 6 tab Painted<br>\$159.00                        | <input type="checkbox"/> XL100 Para grip 6 tab<br>\$400.00<br><i>(700C not available)</i> |
| <input type="checkbox"/> XL070 Aluminium hard anodized 12 tab<br>\$146.00<br><i>(24" not available)</i> | <input type="checkbox"/> XL020 Tetra Grip 6 tab<br>\$400.00                               |

**Tire Options**

- |  |  |
|--|--|
| <input type="checkbox"/> XM070 Kenda Kaliente <input type="checkbox"/> Red <input type="checkbox"/> Blue | <input type="checkbox"/> XM080 Tufo MS3 tubeless<br>\$81.00<br><i>(Blue only)</i>              |
| <input type="checkbox"/> XM150 IRC Exeracer Pro<br>\$185.00<br><i>(Red Only)</i>                         | <input type="checkbox"/> XM090 Tufo WS3 tubeless<br>\$81.00<br><i>(24" only and Blue only)</i> |

**Spare Wheel**

- |  |   |
|--|---|
| <input type="checkbox"/> GXAXK500 Spare wheel Spinerigy<br>\$2,258.00<br><i>(All inclusive + axle pin)</i> | <input type="checkbox"/> XK520 Spare wheel Titanium / Super narrow upcharge<br>\$634.00 |
|--|---|

**Inner Tube Valve Options**

- |   |   |
|---|---|
| <input type="checkbox"/> XY500 Schraeder inner tube valve | <input type="checkbox"/> XY490 Presta inner tube valve<br><i>(Standard if no option selected)</i> |
|---|---|

## FINISH OPTIONS

XN010 Powder coated frame

- | Frame                    | Gloss                  |
|--------------------------|------------------------|
| <input type="checkbox"/> | Black gloss 103        |
| <input type="checkbox"/> | White gloss 100        |
| <input type="checkbox"/> | Grey gloss 132         |
| <input type="checkbox"/> | Cream gloss 135        |
| <input type="checkbox"/> | Red gloss 108          |
| <input type="checkbox"/> | Yellow gloss 120       |
| <input type="checkbox"/> | Forest green gloss 143 |
| <input type="checkbox"/> | Green gloss 107        |
| <input type="checkbox"/> | Dark blue gloss 151    |
| <input type="checkbox"/> | Royal blue gloss 154   |
| <input type="checkbox"/> | Blue gloss 174         |
| <input type="checkbox"/> | Duckegg blue gloss 141 |
| <input type="checkbox"/> | Pink gloss 188         |
| <input type="checkbox"/> | Orange gloss 180       |
| <input type="checkbox"/> | Purple gloss 157       |

- | Frame                    | Matte                |
|--------------------------|----------------------|
| <input type="checkbox"/> | Black matte 105      |
| <input type="checkbox"/> | White matte 101      |
| <input type="checkbox"/> | Grey matte 131       |
| <input type="checkbox"/> | Light grey matte 133 |
| <input type="checkbox"/> | Navy blue matte 152  |

- | Frame                    | Special                  |
|--------------------------|--------------------------|
| <input type="checkbox"/> | Chrome Mirror 300        |
| <input type="checkbox"/> | Sparkle silver 170       |
| <input type="checkbox"/> | Metallic black matte 104 |
| <input type="checkbox"/> | Metallic grey matte 130  |
| <input type="checkbox"/> | Black sandpaper 201      |
| <input type="checkbox"/> | Grey sandpaper 202       |
| <input type="checkbox"/> | White sandpaper 200      |

RGK-XN200 Individual paint colour (State Colour/RAL code)  
\$565.00

GXAXN030 Brushed frame  
\$1,357.00

GXAXN050 Polished frame  
\$1,759.00

### Accent Colour (Choose One)

**Note:** Accent colour includes, forks, castor caps, decals.

- |  |  |  |
|--|--|--|
| <input type="checkbox"/> Black accent  | <input type="checkbox"/> Silver accent                                     | <input type="checkbox"/> RGK-XN250 Individual accent<br>\$315.00                             |
| <input type="checkbox"/> Red accent    | <input type="checkbox"/> Blue accent                                       | <div style="border: 1px solid black; padding: 5px; width: fit-content;">Select Colour:</div> |
| <input type="checkbox"/> Purple accent | <input type="checkbox"/> Carbon accent<br><i>(caps only, others black)</i> |  |

## UPHOLSTERY

### Seat Upholstery

GXAXP040 Seat sling strap adjustable *(not required with seatplate)*

### Backrest Upholstery

GXAXP055 Airtech sport backrest strap adjustable

XP070 Backrest upgrade to leather corners (Black)  
\$121.00

### Backrest Stitching Options

- |                                 |                                     |                                 |                                 |
|---------------------------------|-------------------------------------|---------------------------------|---------------------------------|
| <input type="checkbox"/> Silver | <input type="checkbox"/> Black      | <input type="checkbox"/> Blue   | <input type="checkbox"/> Orange |
| <input type="checkbox"/> Red    | <input type="checkbox"/> Light blue | <input type="checkbox"/> Purple |                                 |

### Backrest RGK Logo Colour

- |                                      |                                     |                                 |                                      |
|--------------------------------------|-------------------------------------|---------------------------------|--------------------------------------|
| <input type="checkbox"/> White (Std) | <input type="checkbox"/> Green      | <input type="checkbox"/> Blue   | <input type="checkbox"/> Individual: |
| <input type="checkbox"/> Red         | <input type="checkbox"/> Light blue | <input type="checkbox"/> Purple | _____                                |

### Backrest Accessories

XP170 Individual backrest embroidery *(Please provide .jpeg file and positioning)*

**CUSHION**

Cushion Foam Options

- XP080 \$121.00 Cushion foam (select density and size below)
  - Soft (CMS040)
  - Medium (CMS050)
  - Hard (9lb recon)
  - 50mm
  - 75mm
  - 100mm
  - Other
- XP340 \$115.00 Plastazote cushion upgrade (Indicate max height)

Cushion Cover Options

- XP085 Nylon cushion cover (Black)
- XP090 \$98.00 Air Lite cushion cover (Black)
- XP380 \$127.00 Neoprene cushion cover (Black)

**STRAPS**

Velcro straps

- XS050 \$173.00 100mm Pro adjustable velcro strap
- XS055 \$135.00 50mm Pro adjustable velcro strap
- XS057 \$250.00 50mm Pro knee strap (measurement from tube to tube over knees)

Velcro strap position

Strap 1

Specify strap length

Specify distance from back post

Strap 1

Specify strap length

Specify distance from back post

- XS020 \$140.00 Sport ratchet strap (Click strap) (11" x 2" pad)
- XS025 \$406.00 Pelvi Loc 2DA ratchet strap (For thighs and knees)
  - Select size:  Medium (8")  Large (10")
- XS030 \$419.00 Pelvi Loc 3DA ratchet strap (For hips)
  - Select size:  Small (8")  Medium (9")
  - Large (10")  Extra Large (11")
- XS035 \$283.00 M2 ratchet strap (For thighs and knees)
  - 8"  10"  12"

Strap 1

Specify distance from back post

Strap 2

Specify distance from back post

- XS040 \$160.00 Fixed mounting points (one set per click strap)  x1  x2  x3
- XS045 \$96.00 Clamped mounting points (one set per click strap)  x1  x2  x3

**FRAME OPTIONS**

- XR060 \$154.00 Calf strap mounting loops
- XR065 \$118.00 Strap location loops

**ACCESSORIES**

- XR030 \$201.00 Triple wheel bag (Black)
- XP130 \$127.00 Frame protectors full length
- XS100 \$103.00 Bodypoint waist strap  Small  Large
- XS070 Foot strap (select if required)
- XS060 Calf strap (select if required)
- XP400 Back bar protector
- XR090 Tool kit



