

# spex<sup>®</sup>

BY



## JAY<sup>®</sup>

Shaping Comfort



CLINICAL  
WHEELCHAIR  
SEATING



Designed and  
manufactured by

medifab<sup>®</sup>

SUNRISEMEDICAL.CA

Shaping better lives  
worldwide through  
clinically proven modular  
wheelchair seating.



# Contents

---

Spex® Standard Contour Cushion	5
Spex® High Contour Cushion	6
Spex® SuperHigh Contour Cushion	8
Spex® Flex Cushion	10
Comfi Back Support	12
Spex® Back Support	14
SuperShape® Back Support	16
Contouring the Spex Back Support Surface	20
Head Supports	21
Lateral Trunk Supports	22
Lateral Support Pads	24
Lateral Thigh Supports	26
Arm Supports	28
Medial Thigh Supports	28
JAY Anterior Positioning	29
JAY Pelvic Positioning	30
Transport Certified	31

---

# spex<sup>®</sup> a history.

Since 1990, Medifab has engineered specialized seating products that provide the optimal blend of form, function and comfort.

The Spex<sup>®</sup> brand is a cultivated result from over 25 years of research, trial, and listening to customer feedback. As industry innovators, we have worked with top clinicians, and tested our products to perform and satisfy. Distinguished by high standards of design and clinical evaluation, Spex delivers a superior clinical seating packed with advantages.

## Benefits of Spex<sup>®</sup>

Spex seating is intended for users who require postural support, and accomplishes what the seating clinician desires, with a focus on minimizing the time taken to reach the solution.

- Clinically appropriate seating choice
- Easy to use from installation to completion
- Solves clients seating needs in minimal time
- Configurable to suit different postural deviations
- Modular flexibility to accommodate changing postural needs
- Installs on virtually any wheelchair base
- Breathable for temperature control
- Standard sizes from 10" pediatrics to large adults with non-standard sizes by request
- Wheelchair transportation safety standards certified

# Spex® Standard Contour Cushion



## CLINICAL

Designed for the user who has moderate to severe positioning and pressure requirements. Excellent choice for individuals who:

- Have changing postural needs over time
- Have a symmetrical or asymmetrical sitting posture that requires correction or control
- Require pelvic comfort and pressure relief/distribution
- Require a high degree of pelvic stability and specific contouring
- Have tight hamstrings/lack of hip flexion
- Need moderate control of abduction or adduction propensities

## FUNCTIONAL

- Created as the solution-solver for asymmetrical postures
- Strategic contouring pads offer complete modifications on-the-spot for a perfect fit for the client
- Gel-foam ischial well evenly distributes pressure under the pelvis and in combination with the dual-layer cover, reduces shear forces in sensitive areas
- Coccyx channel for enhanced pressure relief (for sizes 16" +)
- Dual-layer cover reduces shear forces, and breathable air-mesh on cushion sides counters moisture
- Inner incontinence cover included
- Configurable for many requirements such as leg length discrepancies
- Approx. cushion weight is from 0.7 to 2.6 kg (1.5 to 5.7 lbs.)

Width	Length	Trough Height	Cushion Height	Cushion Code	Spare Cover Code	Incontinence Cover Code
10" / 25.4 cm	10" / 25.4 cm	1.2" / 3 cm	2" / 5 cm	1105-1010-OSC	1125-1010-6SC	1135-1010-7SC
10" / 25.4 cm	12" / 30.5 cm	1.2" / 3 cm	2" / 5 cm	1105-1012-OSC	1125-1012-6SC	1135-1012-7SC
11" / 27.9 cm	10" / 25.4 cm	1.2" / 3 cm	2.5" / 6.4 cm	1105-1110-OSC	1125-1110-6SC	1135-1110-7SC
11" / 27.9 cm	12" / 30.5 cm	1.2" / 3 cm	2.5" / 6.4 cm	1105-1112-OSC	1125-1112-6SC	1135-1112-7SC
12" / 30.5 cm	12" / 30.5 cm	1.2" / 3 cm	2.5" / 6.4 cm	1105-1212-OSC	1125-1212-6SC	1135-1212-7SC
12" / 30.5 cm	14" / 35.6 cm	1.2" / 3 cm	2.5" / 6.4 cm	1105-1214-OSC	1125-1214-6SC	1135-1214-7SC
13" / 33 cm	12" / 30.5 cm	1.2" / 3 cm	2.5" / 6.4 cm	1105-1312-OSC	1125-1312-6SC	1135-1312-7SC
13" / 33 cm	14" / 35.6 cm	1.2" / 3 cm	2.5" / 6.4 cm	1105-1314-OSC	1125-1314-6SC	1135-1314-7SC
14" / 35.6 cm	14" / 35.6 cm	1.2" / 3 cm	2.5" / 6.4 cm	1105-1414-OSC	1125-1414-6SC	1135-1414-7SC
14" / 35.6 cm	16" / 40.6 cm	1.2" / 3 cm	2.5" / 6.4 cm	1105-1416-OSC	1125-1416-6SC	1135-1416-7SC
14" / 35.6 cm	18" / 45.7 cm	1.2" / 3 cm	2.5" / 6.4 cm	1105-1418-OSC	1125-1418-6SC	1135-1418-7SC
15" / 38.1 cm	14" / 35.6 cm	1.2" / 3 cm	2.5" / 6.4 cm	1105-1514-OSC	1125-1514-6SC	1135-1514-7SC
15" / 38.1 cm	16" / 40.6 cm	1.2" / 3 cm	2.5" / 6.4 cm	1105-1516-OSC	1125-1516-6SC	1135-1516-7SC
16" / 40.6 cm	16" / 40.6 cm	1.2" / 3 cm	2.75" / 7 cm	1105-1616-OSC	1125-1616-6SC	1135-1616-7SC
16" / 40.6 cm	18" / 45.7 cm	1.2" / 3 cm	2.75" / 7 cm	1105-1618-OSC	1125-1618-6SC	1135-1618-7SC
16" / 40.6 cm	20" / 50.8 cm	1.2" / 3 cm	2.75" / 7 cm	1105-1620-OSC	1125-1620-6SC	1135-1620-7SC
17" / 43.1 cm	17" / 43.1 cm	1.2" / 3 cm	2.75" / 7 cm	1105-1717-OSC	1125-1717-6SC	1135-1717-7SC
17" / 43.1 cm	18" / 45.7 cm	1.2" / 3 cm	2.75" / 7 cm	1105-1718-OSC	1125-1718-6SC	1135-1718-7SC
18" / 45.7 cm	18" / 45.7 cm	1.2" / 3 cm	3" / 7.6 cm	1105-1818-OSC	1125-1818-6SC	1135-1818-7SC
18" / 45.7 cm	20" / 50.8 cm	1.2" / 3 cm	3" / 7.6 cm	1105-1820-OSC	1125-1820-6SC	1135-1820-7SC
19" / 48.2 cm	18" / 45.7 cm	1.2" / 3 cm	3" / 7.6 cm	1105-1918-OSC	1125-1918-6SC	1135-1918-7SC
19" / 48.2 cm	20" / 50.8 cm	1.2" / 3 cm	3" / 7.6 cm	1105-1920-OSC	1125-1920-6SC	1135-1920-7SC
20" / 50.8 cm	20" / 50.8 cm	1.2" / 3 cm	3" / 7.6 cm	1105-2020-OSC	1125-2020-6SC	1135-2020-7SC
20" / 50.8 cm	22" / 55.9 cm	1.2" / 3 cm	3" / 7.6 cm	1105-2022-OSC	1125-2022-6SC	1135-2022-7SC

# Spex® High Contour Cushion

The Spex High Contour Cushion offers enhanced thigh and abductor support. A key solution to positioning and levelling the pelvis correctly and effectively. Accomplish on-the-spot modifications with the cushion's strategic positioning base.

## CLINICAL

Designed for the user who has moderate to severe positioning and pressure requirements. Excellent choice for individuals who:

- Need high control of abduction or adduction propensities
- Have changing postural needs over time
- Have a symmetrical or asymmetrical sitting posture that requires correction or control
- Require pelvic comfort and pressure relief/distribution
- Require a high degree of pelvic stability and specific contouring

## FUNCTIONAL

- Positioning base accommodates tight hamstrings/lack of hip flexion
- Created as the solution-solver for asymmetrical postures
- Strategic contouring pads offer complete modifications on-the-spot for a perfect fit for the client
- Gel-foam ischial well evenly distributes pressure under the pelvis, and in combination with the dual-layer cover, reduces shear forces in sensitive areas
- Coccyx channel for enhanced pressure relief (for sizes 16"+)
- Dual-layer cover reduces shear forces, and breathable air-mesh on cushion sides counters moisture
- Inner incontinence cover included
- Configurable for many requirements such as leg length discrepancies
- Approx. cushion weight is from 0.8 to 2.7 kg (1.75 to 6 lbs.)



Bespoke modifications can be scripted according to needs of the user.

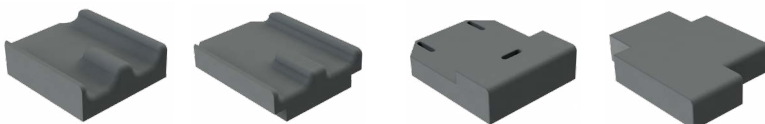

## SPEX STRATEGIC POSITIONING BASE

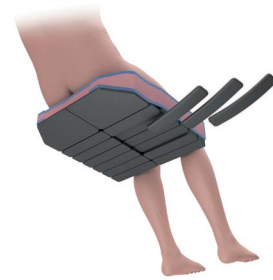

Configure clients to suit many different postures of persons with disabilities or sitting issues. By adjusting the strategic positioning base, the cushion surface is contoured to improve overall posture, pelvic alignment, sitting ability, comfort and pressure reduction.



## TIGHT HAMSTRINGS / LIMITED HIP FLEXION / POSTERIOR PELVIC TILT

Cushion can be wedged to slope to front with cells added at rear and removed at front.

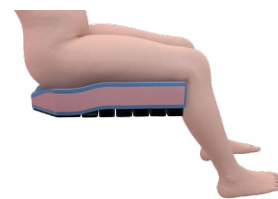

## MANAGEMENT & POSITIONING

Build cells up under thighs for enhanced pre-ischial support and control.

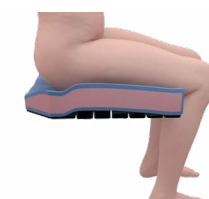

## PELVIC ROTATION

To help control pelvis from rotating, create a build-up under the affected leg (in front of the ischial).



Unique dual-layer **SHEAR REDUCTION** fabric surface

Accentuated thigh/adductor and abductor **CONTROL AND SUPPORT**

**CONFIGURE** for all sitting postures

Maintain **PELVIC STABILITY** with adjustable positioning base

Width	Length	Trough Height	Cushion Height	Cushion Code	Spare Cover Code	Incontinence Cover Code
10" / 25.4 cm	10" / 25.4 cm	2" / 5 cm	2" / 5 cm	1105-1010-0HC	1125-1010-6HC	1135-1010-7HC
10" / 25.4 cm	12" / 30.5 cm	2" / 5 cm	2" / 5 cm	1105-1012-0HC	1125-1012-6HC	1135-1012-7HC
11" / 27.9 cm	10" / 25.4 cm	2" / 5 cm	2.5" / 6.4 cm	1105-1110-0HC	1125-1110-6HC	1135-1110-7HC
11" / 27.9 cm	12" / 30.5 cm	2" / 5 cm	2.5" / 6.4 cm	1105-1112-0HC	1125-1112-6HC	1135-1112-7HC
12" / 30.5 cm	12" / 30.5 cm	2" / 5 cm	2.5" / 6.4 cm	1105-1212-0HC	1125-1212-6HC	1135-1212-7HC
12" / 30.5 cm	14" / 35.6 cm	2" / 5 cm	2.5" / 6.4 cm	1105-1214-0HC	1125-1214-6HC	1135-1214-7HC
13" / 33 cm	12" / 30.5 cm	2" / 5 cm	2.5" / 6.4 cm	1105-1312-0HC	1125-1312-6HC	1135-1312-7HC
13" / 33 cm	14" / 35.6 cm	2" / 5 cm	2.5" / 6.4 cm	1105-1314-0HC	1125-1314-6HC	1135-1314-7HC
14" / 35.6 cm	14" / 35.6 cm	2" / 5 cm	2.5" / 6.4 cm	1105-1414-0HC	1125-1414-6HC	1135-1414-7HC
14" / 35.6 cm	16" / 40.6 cm	2" / 5 cm	2.5" / 6.4 cm	1105-1416-0HC	1125-1416-6HC	1135-1416-7HC
14" / 35.6 cm	18" / 45.7 cm	2" / 5 cm	2.5" / 6.4 cm	1105-1418-0HC	1125-1418-6HC	1135-1418-7HC
15" / 38.1 cm	14" / 35.6 cm	2" / 5 cm	2.5" / 6.4 cm	1105-1514-0HC	1125-1514-6HC	1135-1514-7HC
15" / 38.1 cm	16" / 40.6 cm	2" / 5 cm	2.5" / 6.4 cm	1105-1516-0HC	1125-1516-6HC	1135-1516-7HC
16" / 40.6 cm	16" / 40.6 cm	2" / 5 cm	2.75" / 7 cm	1105-1616-0HC	1125-1616-6HC	1135-1616-7HC
16" / 40.6 cm	18" / 45.7 cm	2" / 5 cm	2.75" / 7 cm	1105-1618-0HC	1125-1618-6HC	1135-1618-7HC
16" / 40.6 cm	20" / 50.8 cm	2" / 5 cm	2.75" / 7 cm	1105-1620-0HC	1125-1620-6HC	1135-1620-7HC
17" / 43.1 cm	17" / 43.1 cm	2" / 5 cm	2.75" / 7 cm	1105-1717-0HC	1125-1717-6HC	1135-1717-7HC
17" / 43.1 cm	18" / 45.7 cm	2" / 5 cm	2.75" / 7 cm	1105-1718-0HC	1125-1718-6HC	1135-1718-7HC
18" / 45.7 cm	18" / 45.7 cm	2" / 5 cm	3" / 7.6 cm	1105-1818-0HC	1125-1818-6HC	1135-1818-7HC
18" / 45.7 cm	20" / 50.8 cm	2" / 5 cm	3" / 7.6 cm	1105-1820-0HC	1125-1820-6HC	1135-1820-7HC
19" / 48.2 cm	18" / 45.7 cm	2" / 5 cm	3" / 7.6 cm	1105-1918-0HC	1125-1918-6HC	1135-1918-7HC
19" / 48.2 cm	20" / 50.8 cm	2" / 5 cm	3" / 7.6 cm	1105-1920-0HC	1125-1920-6HC	1135-1920-7HC
20" / 50.8 cm	20" / 50.8 cm	2" / 5 cm	3" / 7.6 cm	1105-2020-0HC	1125-2020-6HC	1135-2020-7HC
20" / 50.8 cm	22" / 55.9 cm	2" / 5 cm	3" / 7.6 cm	1105-2022-0HC	1125-2022-6HC	1135-2022-7HC

# Spex® SuperHigh Contour Cushion

Using the proven Spex strategic positioning base technology, the SuperHigh Contour Cushion creates an optimum pelvic foundation for the user who requires extra pelvic and hip immersion.

Its properties provide hip/leg envelopment as well as an ideal pressure redistribution all over the seat cushion. The medial thigh support combined with lateral thigh supports maximizes the user stability, providing greater balance and support on the upper body. The SuperHigh Contour Cushion's body-hugging nature delivers comfort and daily sitting relief; while the 3D breathable mesh fabric helps in reducing moisture and temperature.

## CLINICAL

Designed for the user who has moderate to severe positioning requirements. Excellent choice for individuals who:

- Require extra pelvic and hip immersion
- Have muscle tone patterns that require sufficient thigh lateral control. Thigh support is higher for alignment - refer to measurement table
- If extremity support can't be maintained through the use of external thigh laterals and/or if installing thigh laterals can't be used, the SuperHigh Contour Cushion will provide that needed support and stabilization
- Have a symmetrical or asymmetrical sitting posture that requires correction or control/accommodation
- Require pelvic comfort and pressure relief/distribution
- Require a high degree of pelvic stability and specific contouring

## FUNCTIONAL

- Positioning base accommodates tight hamstrings/lack of hip flexion
- No maintenance required. A reliable, peace-of-mind solution!
- Strategic contouring pads offer complete modifications on-the-spot for a perfect fit for the client
- Removable lateral rigidizers which add extra thigh support/alignment
- Gel-foam ischial well evenly distributes pressure under the pelvis, and in combination with the dual-layer cover, reduces shear forces in sensitive areas
- Coccyx channel for enhanced pressure relief (for sizes 16"+)
- Dual-layer cover reduces shear forces, and breathable air-mesh on cushion sides counters moisture
- Inner incontinence cover included
- Configurable for many requirements such as leg length discrepancies
- Not compatible with Thigh Supports or Medial Thigh Supports
- Approx. cushion weight is from 0.9 to 2.8 kg (2 to 6.2 lbs.)

Bespoke modifications can be scripted according to needs of the user.

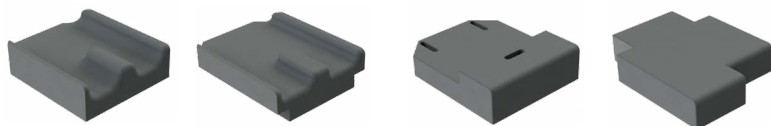

## SPEX® STRATEGIC POSITIONING BASE

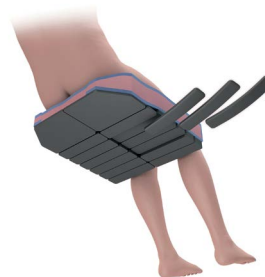

Configure to suit many different postures of persons with disabilities or sitting issues. By adjusting the strategic positioning base, the cushion surface is contoured to improve overall posture, pelvic alignment, sitting ability, comfort and pressure reduction.



## TIGHT HAMSTRINGS / LIMITED HIP FLEXION / POSTERIOR PELVIC TILT

Cushion can be wedged to slope to front with cells added at rear and removed at front.

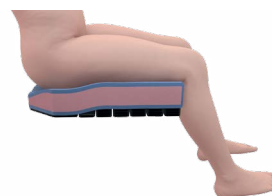

## MANAGEMENT & POSITIONING

Build cells up under thighs for enhanced pre-ischial support and control.

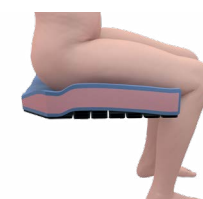

## PELVIC ROTATION

To help control pelvis from rotating, create a build-up under the affected leg (in front of the ischial).





Deep **PELVIC IMMERSION**  
for ultimate pressure relief  
and comfort

Super high medial and lateral  
contouring for **STABILITY  
AND CONTROL**

Cross-linked foam profiles  
for **DURABILITY**

Maintain **PELVIC STABILITY**  
with adjustable positioning  
base

Width	Length	Trough Height	Cushion Code	Spare Cover Code	Incontinence Cover Code
10" / 25.4 cm	10" / 25.4 cm	3.15" / 8 cm	1105-1010-OSS	1125-1010-6SH	1135-1010-7SH
10" / 25.4 cm	12" / 30.5 cm	3.15" / 8 cm	1105-1012-OSS	1125-1012-6SH	1135-1012-7SH
11" / 27.9 cm	10" / 25.4 cm	3.15" / 8 cm	1105-1110-OSS	1125-1110-6SH	1135-1110-7SH
11" / 27.9 cm	12" / 30.5 cm	3.15" / 8 cm	1105-1112-OSS	1125-1112-6SH	1135-1112-7SH
12" / 30.5 cm	12" / 30.5 cm	3.15" / 8 cm	1105-1212-OSS	1125-1212-6SH	1135-1212-7SH
12" / 30.5 cm	14" / 35.6 cm	3.15" / 8 cm	1105-1214-OSS	1125-1214-6SH	1135-1214-7SH
13" / 33 cm	12" / 30.5 cm	3.15" / 8 cm	1105-1312-OSS	1125-1312-6SH	1135-1312-7SH
13" / 33 cm	14" / 35.6 cm	3.15" / 8 cm	1105-1314-OSS	1125-1314-6SH	1135-1314-7SH
14" / 35.6 cm	14" / 35.6 cm	3.94" / 10 cm	1105-1414-OSS	1125-1414-6SH	1135-1414-7SH
14" / 35.6 cm	16" / 40.6 cm	3.94" / 10 cm	1105-1416-OSS	1125-1416-6SH	1135-1416-7SH
14" / 35.6 cm	18" / 45.7 cm	3.94" / 10 cm	1105-1418-OSS	1125-1418-6SH	1135-1418-7SH
15" / 38.1 cm	14" / 35.6 cm	3.94" / 10 cm	1105-1514-OSS	1125-1514-6SH	1135-1514-7SH
15" / 38.1 cm	16" / 40.6 cm	3.94" / 10 cm	1105-1516-OSS	1125-1516-6SH	1135-1516-7SH
16" / 40.6 cm	16" / 40.6 cm	3.94" / 10 cm	1105-1616-OSS	1125-1616-6SH	1135-1616-7SH
16" / 40.6 cm	18" / 45.7 cm	3.94" / 10 cm	1105-1618-OSS	1125-1618-6SH	1135-1618-7SH
16" / 40.6 cm	20" / 50.8 cm	3.94" / 10 cm	1105-1620-OSS	1125-1620-6SH	1135-1620-7SH
17" / 43.1 cm	17" / 43.1 cm	3.94" / 10 cm	1105-1717-OSS	1125-1717-6SH	1135-1717-7SH
17" / 43.1 cm	18" / 45.7 cm	3.94" / 10 cm	1105-1718-OSS	1125-1718-6SH	1135-1718-7SH
18" / 45.7 cm	18" / 45.7 cm	3.94" / 10 cm	1105-1818-OSS	1125-1818-6SH	1135-1818-7SH
18" / 45.7 cm	20" / 50.8 cm	3.94" / 10 cm	1105-1820-OSS	1125-1820-6SH	1135-1820-7SH
19" / 48.2 cm	18" / 45.7 cm	3.94" / 10 cm	1105-1918-OSS	1125-1918-6SH	1135-1918-7SH
19" / 48.2 cm	20" / 50.8 cm	3.94" / 10 cm	1105-1920-OSS	1125-1920-6SH	1135-1920-7SH
20" / 50.8 cm	20" / 50.8 cm	3.94" / 10 cm	1105-2020-OSS	1125-2020-6SH	1135-2020-7SH
20" / 50.8 cm	22" / 55.9 cm	3.94" / 10 cm	1105-2022-OSS	1125-2022-6SH	1135-2022-7SH

# Spex® Flex Cushion

Creating possibilities for complex sitting postures! Flex cushion implements a truly adaptable and easy approach for even the hardest-to-solve cushion requirements for users with complex postures.

As its name describes, Flex has been designed to fulfil the postural requirements of wheelchair users who present with limited hip flexion. Up-to-date research shows that a considerable number of clients with cerebral palsy at GMFCS level V, present with asymmetric limited hip flexion. This condition must be ruled out or compensated as it has been linked to the development of other conditions like pelvic obliquity, trunk asymmetry, scoliosis, and windswept hip distortion (Ágústsson, A. et al, 2017).

Considering a lack of products available that can support clients with symmetric or asymmetric limited hip flexion, and considering the negative impact that this can have on people's posture and function, we have developed this superior, comfortable, pressure relieving, stable and highly configurable cushion able to address even the most challenging postural requirements.

Every Flex comes with an easily configurable strategic positioning base. The innovative and clinical benefits of the pads and wedges allows the prescribing clinician to achieve a result on-the-spot whilst having the peace of mind that its able to change for future unseen posture changes. Flex has a unique cover design which can change its shape. This ensures that once all the adaptations are done to the inner foam unit, the incontinence and outer covers are manipulated for a comfortable fit.

## CLINICAL

Designed for the user who has moderate to severe positioning requirements. Excellent choice for individuals who:

- Require extra pelvic and hip immersion
- Have symmetrical or asymmetrical limited hip flexion
- Have internal hip rotation with tight hamstrings on one side
- Require pelvic and thighs pressure distribution due to asymmetric sitting posture
- Have changing postural needs over time
- Require a high degree of pelvic stability and specific contouring

## FUNCTIONAL

- Positioning base primarily accommodates lack of hip flexion up to 20° but due to its innovative positioning base it can support ruling out other associated deformities as pelvic obliquity, windsweeping, hip abduction, hip internal rotation with tight hamstrings and even lack of hip extension
- Strategic positioning base, pads and wedges offer complete modifications on-the-spot for a perfect fit for the user
- Bevelled front edge allow for knee contractures
- The exceptional combination of top foam overlays guarantees pressure distribution throughout the complete surface
- Outer breathable cover and inner incontinence cover included
- Modifiable for individual requirements such as higher thigh supports, leg length discrepancies, among others

## SPEX® FLEX CUSHION BREAKDOWN



- Cushion with outer cover



- Cushion with incontinence cover



- Foam inner with positioning base

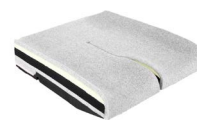

- Foam inner without positioning base



- Positioning base



Strategic positioning base offers on-the-spot modifications to accommodate even the most complex postural needs.



Asymmetric limited hip flexion is achieved by removing one or more frontal wedges from that side, depending on the angle required.



Lack of hip flexion on one side with lack of hip extension on the other is now possible to be compensated by changing the wedges from one side to the other. If pelvic obliquity is present, positioning pads provided with the cushion must be adjusted as well.



Symmetric limited hip flexion is achieved by removing one or more frontal wedges from both sides, depending on the angle required.



If hip abduction needs to be addressed, the frontal segments of the cushions can be pulled apart and locked in place with an additional wedge (provided).



If a moderate windsweeping needs to be accommodated, the frontal segments of the cushion can be slightly angled.

Width	Length	Cushion Code	Spare Cover Code	Incontinence Cover Code
12" / 30.5 cm	14" / 35.6 cm	1106-1214-OSC	1126-1214-6SC / -6HC	1126-1214-7SC / -7HC
13" / 33 cm	14" / 35.6 cm	1106-1314-OSC	1126-1314-6SC / -6HC	1126-1314-7SC / -7HC
14" / 35.6 cm	14" / 35.6 cm	1106-1414-OSC	1126-1414-6SC / -6HC	1126-1414-7SC / -7HC
14" / 35.6 cm	16" / 40.6 cm	1106-1416-OSC	1126-1416-6SC / -6HC	1126-1416-7SC / -7HC
14" / 35.6 cm	18" / 45.7 cm	1106-1418-OSC	1126-1418-6SC / -6HC	1126-1418-7SC / -7HC
15" / 38.1 cm	14" / 35.6 cm	1106-1514-OSC	1126-1514-6SC / -6HC	1126-1514-7SC / -7HC
15" / 38.1 cm	16" / 40.6 cm	1106-1516-OSC	1126-1516-6SC / -6HC	1126-1516-7SC / -7HC
15" / 38.1 cm	18" / 45.7 cm	1106-1518-OSC	1126-1518-6SC / -6HC	1126-1518-7SC / -7HC
16" / 40.6 cm	16" / 40.6 cm	1106-1616-OSC	1126-1616-6SC / -6HC	1126-1616-7SC / -7HC
16" / 40.6 cm	18" / 45.7 cm	1106-1618-OSC	1126-1618-6SC / -6HC	1126-1618-7SC / -7HC
16" / 40.6 cm	20" / 50.8 cm	1106-1620-OSC	1126-1620-6SC / -6HC	1126-1620-7SC / -7HC
17" / 43.1 cm	18" / 45.7 cm	1106-1718-OSC	1126-1718-6SC / -6HC	1126-1718-7SC / -7HC
17" / 43.1 cm	20" / 50.8 cm	1106-1720-OSC	1126-1720-6SC / -6HC	1126-1720-7SC / -7HC
18" / 45.7 cm	18" / 45.7 cm	1106-1818-OSC	1126-1818-6SC / -6HC	1126-1818-7SC / -7HC
18" / 45.7 cm	20" / 50.8 cm	1106-1820-OSC	1126-1820-6SC / -6HC	1126-1820-7SC / -7HC
19" / 48.2 cm	18" / 45.7 cm	1106-1918-OSC	1126-1918-6SC / -6HC	1126-1918-7SC / -7HC
19" / 48.2 cm	20" / 50.8 cm	1106-1920-OSC	1126-1920-6SC / -6HC	1126-1920-7SC / -7HC
20" / 50.8 cm	20" / 50.8 cm	1106-2020-OSC	1126-2020-6SC / -6HC	1126-2020-7SC / -7HC

# Comfi Back Support

The Comfi Back Support foam system was developed to provide a simplistic approach to basic contouring needs while coupling this with Spex Air-Flow technology. Skin breakdown is most often caused by three combined extrinsic factors: Pressure, shear and moisture.

## CLINICAL

- Designed for the individual who requires a solid back support to assist with mild to moderate postural needs
- Ideal to assist clients who may need pressure relief in identified areas
- The cut grid shape and configuration creates a mild suspension effect which provides comfort and increases sitting tolerance
- Suitable for geriatric users who need comfort, minor shaping and pressure-relieving back surface

## FUNCTIONAL

- Comfortable pressure reducing foam surface layer to absorb bony prominences.
- Cubes allow tear-off function to remove pressure areas
- Dual-layer cover reduces shear forces
- Breathable air-mesh on back support sides counters moisture and temperature
- Swap out the upholstery unit at any future point to full Spex contouring system if required, utilizing the same shell and mounting hardware.
- Approx. Comfi weight is from 1.5 to 4 kg (3.3 to 8.8 lbs.)

## TEAR OFF CUBES

Ability to accommodate bony prominences or to relieve tender spots or lesions. Molds without resistance to both concave and convex flexion.



## INSTANT IMMERSION

Auto-conforming of the foam support unit through the combination of thermosensitive foam and cube technology.



## HARDWARE OPTIONS

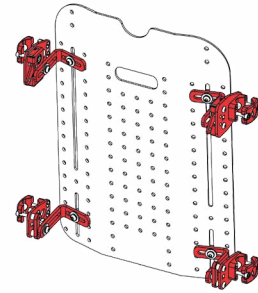

### QUAD MOUNT (DEFAULT)

Default hardware with 4 points of attachment for ultimate strength. #1259-2400-100

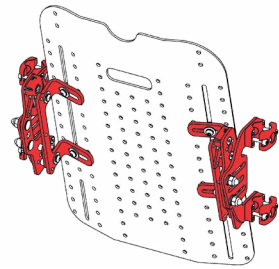

### DUAL MOUNT (OPTION)

Increased adjustability, angle and growth. #1259-2200-100

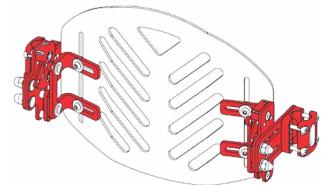

### SINGLE MOUNT (OPTION)

For lower height backs, and as a lightweight option. #1259-2100-100



Tear-off padding to assure **PRESSURE RELIEF** in identified areas

**SMOOTH CONTOURING** surface

**BREATHABLE CUBES** increase air flow through the back support offering daily comfort

Soft memory foam overlay to provide **COMFORT AND PRESSURE REDUCTION**

W/C Width	Height	Comfi Back Support Code	Spare Cover Code
10" / 25.4 cm	12" / 30.5 cm	1253-1012-00H	1253-1012-00H
10" / 25.4 cm	14" / 35.6 cm	1253-1014-00H	1253-1014-00H
10" / 25.4 cm	16" / 40.6 cm	1253-1016-00H	1253-1016-00H
12" / 30.5 cm	14" / 35.6 cm	1253-1214-00H	1253-1214-00H
12" / 30.5 cm	16" / 40.6 cm	1253-1216-00H	1253-1216-00H
12" / 30.5 cm	18" / 45.7 cm	1253-1218-00H	1253-1218-00H
14" / 35.6 cm	16" / 40.6 cm	1253-1416-00H	1253-1416-00H
14" / 35.6 cm	18" / 45.7 cm	1253-1418-00H	1253-1418-00H
14" / 35.6 cm	20" / 50.8 cm	1253-1420-00H	1253-1420-00H
16" / 40.6 cm	18" / 45.7 cm	1253-1618-00H	1253-1618-00H
16" / 40.6 cm	20" / 50.8 cm	1253-1620-00H	1253-1620-00H
16" / 40.6 cm	23" / 58.4 cm	1253-1623-00H	1253-1623-00H
17" / 43.2 cm	18" / 45.7 cm	1253-1718-00H	1253-1718-00H
17" / 43.2 cm	20" / 50.8 cm	1253-1720-00H	1253-1720-00H
17" / 43.2 cm	23" / 58.4 cm	1253-1723-00H	1253-1723-00H
18" / 45.7 cm	18" / 45.7 cm	1253-1818-00H	1253-1818-00H
18" / 45.7 cm	20" / 50.8 cm	1253-1820-00H	1253-1820-00H
18" / 45.7 cm	23" / 58.4 cm	1253-1823-00H	1253-1823-00H
20" / 50.8 cm	18" / 45.7 cm	1253-2018-00H	1253-2018-00H
20" / 50.8 cm	20" / 50.8 cm	1253-2020-00H	1253-2020-00H
20" / 50.8 cm	23" / 58.4 cm	1253-2023-00H	1253-2023-00H

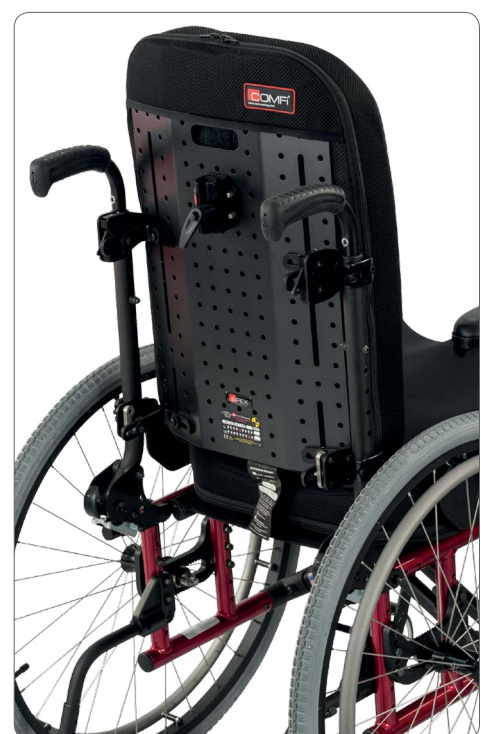

# Spex® Back Support

Easily solve upper torso needs for most wheelchair users with the Spex exceptional upholstery section. Incorporates the Spex cube contouring cell system to allow on-the-spot modifications for torso comfort and asymmetry needs.

## CLINICAL

Designed for the individual who:

- Requires a comfortable back support to reduce torso pain
- Requires spinal alignment and support
- Has skin breakdown/pressure care needs
- Has bony or protruding skeletal prominences
- Has changing postural needs
- Appropriate for a maladaptive or asymmetric posture

## FUNCTIONAL

- Comfortable pressure reducing foam surface layer to absorb bony prominences
- Cube contouring cell system provides configurations for a perfect fit and shape for the client
- Modification to contouring is performed on-the-spot
- Created as the solution-solver for asymmetrical back postures
- Modular componentry means you can 'mix and match' with different lateral pad options and positioning supports
- Offers exceptional back/shoulder contact
- Sustainable choice for issuing to other users
- Dual-layer cover reduces shear forces, and breathable air-mesh on back support sides counters moisture and temperature
- Approx. Spex Back Support weight is from 1.3 to 3.8 kg (2.9 to 8.4 lbs.)

## RECTANGLE SHAPE

Fits between wheelchair canes



## T SHAPE

Sits in front of wheelchair canes

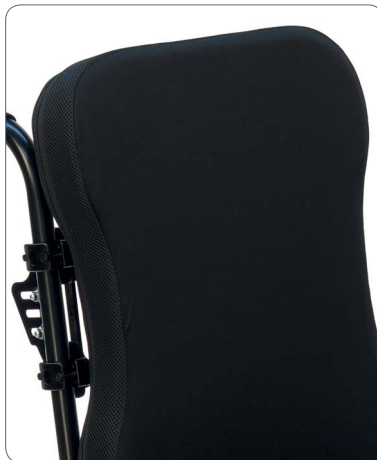

## HARDWARE OPTIONS

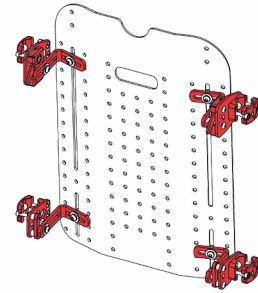

### QUAD MOUNT (DEFAULT)

Default hardware with 4 points of attachment for ultimate strength. #1259-2400-100

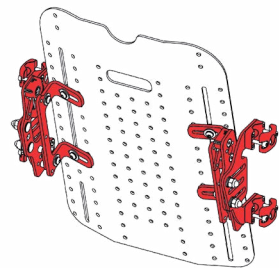

### DUAL MOUNT (OPTION)

Increased adjustability, angle and growth. #1259-2200-100

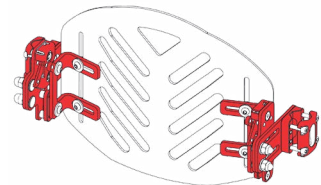

### SINGLE MOUNT (OPTION)

For lower height backs, and as a lightweight option. #1259-2100-100



Dual-layer cover reduces **SHEAR FORCES** with air-mesh side panels to counter moisture and temperature

Add laterals as required from our **LARGE MODULAR RANGE**

Strong **VENTILATED SHELL** increases air flow through the back support offering daily comfort

**SLOTS & HOLE POSITIONS** on shell allow easy installation of head supports, lateral supports and harnesses

W/C Width	Height	Rectangle Shape Backrest Code	Rectangle Shape Spare Cover Code	T Shape Backrest Code	T Shape Spare Cover Code
10" / 25.4 cm	12" / 30.5 cm	1255-1012-OSS	1255-1012-OSS-C	1255-1012-OTS	1255-1012-OTS-C
10" / 25.4 cm	14" / 35.6 cm	1255-1014-OSS	1255-1014-OSS-C	1255-1014-OTS	1255-1014-OTS-C
10" / 25.4 cm	16" / 40.6 cm	1255-1016-OSS	1255-1016-OSS-C	1255-1016-OTS	1255-1016-OTS-C
12" / 30.5 cm	14" / 35.6 cm	1255-1214-OSS	1255-1214-OSS-C	1255-1214-OTS	1255-1214-OTS-C
12" / 30.5 cm	16" / 40.6 cm	1255-1216-OSS	1255-1216-OSS-C	1255-1216-OTS	1255-1216-OTS-C
12" / 30.5 cm	18" / 45.7 cm	1255-1218-OSS	1255-1218-OSS-C	1255-1218-OTS	1255-1218-OTS-C
14" / 35.6 cm	16" / 40.6 cm	1255-1416-OSS	1255-1416-OSS-C	1255-1416-OTS	1255-1416-OTS-C
14" / 35.6 cm	18" / 45.7 cm	1255-1418-OSS	1255-1418-OSS-C	1255-1418-OTS	1255-1418-OTS-C
14" / 35.6 cm	20" / 50.8 cm	1255-1420-OSS	1255-1420-OSS-C	1255-1420-OTS	1255-1420-OTS-C
16" / 40.6 cm	16" / 40.6 cm	1255-1616-OSS	1255-1616-OSS-C	1255-1616-OTS	1255-1616-OTS-C
16" / 40.6 cm	18" / 45.7 cm	1255-1618-OSS	1255-1618-OSS-C	1255-1618-OTS	1255-1618-OTS-C
16" / 40.6 cm	20" / 50.8 cm	1255-1620-OSS	1255-1620-OSS-C	1255-1620-OTS	1255-1620-OTS-C
16" / 40.6 cm	23" / 58.4 cm	1255-1623-OSS	1255-1623-OSS-C	1255-1623-OTS	1255-1623-OTS-C
17" / 43.2 cm	18" / 45.7 cm	1255-1718-OSS	1255-1718-OSS-C	1255-1718-OTS	1255-1718-OTS-C
17" / 43.2 cm	20" / 50.8 cm	1255-1720-OSS	1255-1720-OSS-C	1255-1720-OTS	1255-1720-OTS-C
17" / 43.2 cm	23" / 58.4 cm	1255-1723-OSS	1255-1723-OSS-C	1255-1723-OTS	1255-1723-OTS-C
18" / 45.7 cm	18" / 45.7 cm	1255-1818-OSS	1255-1818-OSS-C	1255-1818-OTS	1255-1818-OTS-C
18" / 45.7 cm	20" / 50.8 cm	1255-1820-OSS	1255-1820-OSS-C	1255-1820-OTS	1255-1820-OTS-C
18" / 45.7 cm	23" / 58.4 cm	1255-1823-OSS	1255-1823-OSS-C	1255-1823-OTS	1255-1823-OTS-C
20" / 50.8 cm	18" / 45.7 cm	1255-2018-OSS	1255-2018-OSS-C	1255-2018-OTS	1255-2018-OTS-C
20" / 50.8 cm	20" / 50.8 cm	1255-2020-OSS	1255-2020-OSS-C	1255-2020-OTS	1255-2020-OTS-C
20" / 50.8 cm	23" / 58.4 cm	1255-2023-OSS	1255-2023-OSS-C	1255-2023-OTS	1255-2023-OTS-C

# SuperShape® Back Support

SuperShape provides an extra supportive wheelchair back solution with Shape Technology for contouring to provide postural integrity, pressure relief and comfort. Successfully meets individual trunk shapes of users with complex postural needs. SuperShape is a seating system that can be fitted and changed anywhere and at any time.

## CLINICAL

Designed for the individual who:

- Has complex postural needs
- Has significant spinal or trunk asymmetries
- Has protruding skeletal prominences
- Risks skin breakdown and has pressure care requirements
- Requires greater immersion into back support for stability and comfort
- Requires torso pain reduction

## FUNCTIONAL BENEFITS

- Expansion fabric cover that allows all kind of contouring without compromising skin protection
- Comfortable pressure reducing foam surface layer to absorb bony prominences
- Triple-layered cube contouring cell system provides configurations for a perfect fit and shape for the client
- Modification to contouring is performed on-the-spot, as many times as you want
- Created as the solution-solver for asymmetrical back postures
- Modular componentry means you can 'mix and match' with different lateral pad options and positioning supports
- Deep contour solution which offers exceptional contact to contoured areas of the body

## ACCESSORIES

- Spare outer cover
- Extra positioning wedges
- Lateral supports, head supports - options from Spex range

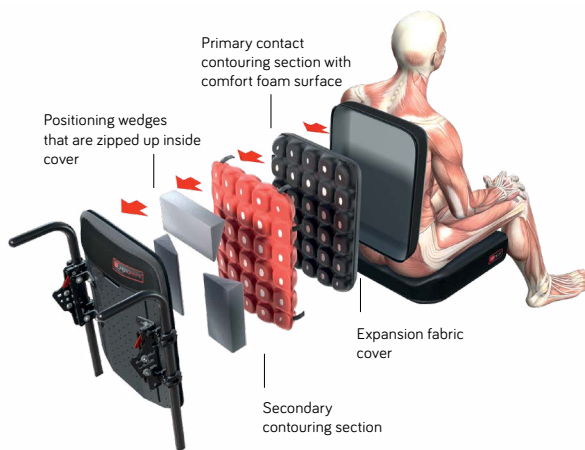

## MODERATE NEEDS

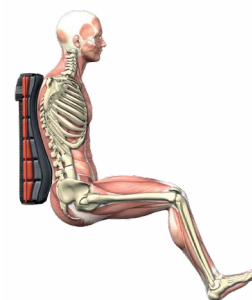

Contouring of the cushioning is provided by creating areas of greater or lesser support by adjusting the multiple layered padded pocket cells

## COMPLEX NEEDS



On-the-spot contouring allows the patient to adopt their preferred posture for maximum function and comfort.

## PERSONALIZED NEEDS



SuperShape's simple method accomplishes superior seating results by accurately contouring to the complex shapes seen in highly involved clients.



Contouring of the cushioning is essential to apply intimate surface contact to areas of the body which are contoured.

The padded molding structure is comprised of a three-layered Spex cube contouring substrate.

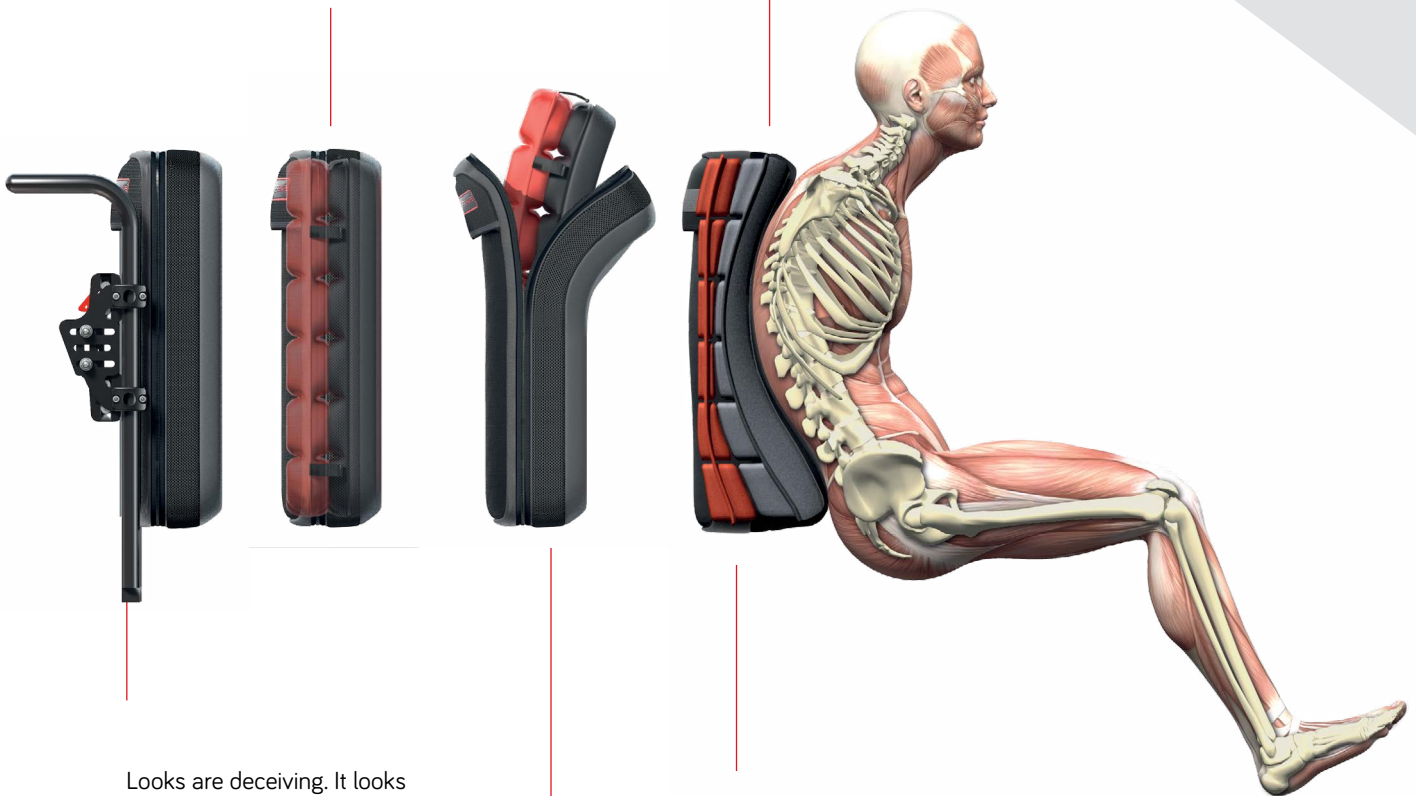

Looks are deceiving. It looks like another smart Spex product, however the SuperShape has concealed technology!

Best result is achieved by creating areas of greater or lesser support with the adjustment of the multiple layered padded pocket cells.

The front padded surface has a super-soft viscoelastic foam for enhanced trunk immersion and comfort.

# SuperShape® Back Support

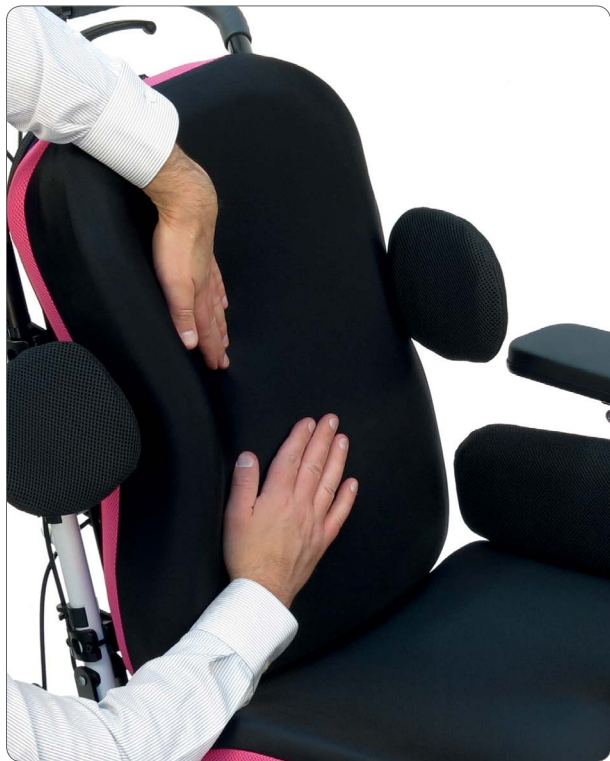

## HOW SUPERSHAPE® WORKS:

- SuperShape Back Support can be fitted to virtually any wheelchair chassis
- Contouring system is comprised of three layers of pockets where padding can be increased or decreased to provide different shapes to suit any individual
- Contouring can effectively make an intimate interface contact for even pressure distribution and comfort
- Easily adapted to accommodate complex postural needs such as kyphosis, scoliosis, hyperlordosis
- Angle, depth and height adjustable
- Breathable, washable cover
- Sizes available from 10" to 20" (25 cm to 50 cm) and in different heights for each width. Approx. SuperShape weight is from 1.6 to 4.5 kg (3.5 to 10 lbs.)
- Choose from a large range of lateral supports and head supports



## SOLVE COMPLEX CASES:

- SuperShape can adapt to changing needs and provide enough stability for complex and asymmetric postures
- With the large range of Spex support options available, it is possible to start building a seating system using off-the-shelf products and then size and adjust them to achieve a one-of-a-kind fit for a user with complex postural needs.
- Easy set-up and optimum interfacing with a range of wheelchair chassis
- Wide range of adjustment for growth and changing needs
- Wide range of lateral supports (sizes, models and adjustments)
- Robust and durable
- Comfortable and pressure relieving



Expansion fabric cover that allows all kinds of contouring without compromising skin protection.



Contouring pockets provide easy adjustment, and positioning will not slip or move once completed.



Triple-layered cube contouring cell system provides configurations for a perfect fit and shape for the client.



2 densities of contouring pads included in every kit to ensure correct personal fitting.

W/C Width	Height	Back Support Code	Back Support Spare Cover Code
10" / 25.4 cm	12" / 30.5 cm	1256-1012-OSS	1256-1012-OSS-C
10" / 25.4 cm	14" / 35.6 cm	1256-1014-OSS	1256-1014-OSS-C
10" / 25.4 cm	16" / 40.6 cm	1256-1016-OSS	1256-1016-OSS-C
12" / 30.5 cm	12" / 30.5 cm	1256-1212-OSS	1256-1212-OSS-C
12" / 30.5 cm	14" / 35.6 cm	1256-1214-OSS	1256-1214-OSS-C
12" / 30.5 cm	16" / 40.6 cm	1256-1216-OSS	1256-1216-OSS-C
12" / 30.5 cm	18" / 45.7 cm	1256-1218-OSS	1256-1218-OSS-C
14" / 35.6 cm	14" / 35.6 cm	1256-1414-OSS	1256-1414-OSS-C
14" / 35.6 cm	16" / 40.6 cm	1256-1416-OSS	1256-1416-OSS-C
14" / 35.6 cm	18" / 45.7 cm	1256-1418-OSS	1256-1418-OSS-C
14" / 35.6 cm	20" / 50.8 cm	1256-1420-OSS	1256-1420-OSS-C
16" / 40.6 cm	16" / 40.6 cm	1256-1616-OSS	1256-1616-OSS-C
16" / 40.6 cm	18" / 45.7 cm	1256-1618-OSS	1256-1618-OSS-C
16" / 40.6 cm	20" / 50.8 cm	1256-1620-OSS	1256-1620-OSS-C
16" / 40.6 cm	23" / 58.4 cm	1256-1623-OSS	1256-1623-OSS-C

W/C Width	Height	Back Support Code	Back Support Spare Cover Code
17" / 43.2 cm	16" / 40.6 cm	1256-1716-OSS	1256-1716-OSS-C
17" / 43.2 cm	18" / 45.7 cm	1256-1718-OSS	1256-1718-OSS-C
17" / 43.2 cm	20" / 50.8 cm	1256-1720-OSS	1256-1720-OSS-C
17" / 43.2 cm	23" / 58.4 cm	1256-1723-OSS	1256-1723-OSS-C
18" / 45.7 cm	16" / 40.6 cm	1256-1816-OSS	1256-1816-OSS-C
18" / 45.7 cm	18" / 45.7 cm	1256-1818-OSS	1256-1818-OSS-C
18" / 45.7 cm	20" / 50.8 cm	1256-1820-OSS	1256-1820-OSS-C
18" / 45.7 cm	23" / 58.4 cm	1256-1823-OSS	1256-1823-OSS-C
20" / 50.8 cm	16" / 40.6 cm	1256-2016-OSS	1256-2016-OSS-C
20" / 50.8 cm	18" / 45.7 cm	1256-2018-OSS	1256-2018-OSS-C
20" / 50.8 cm	20" / 50.8 cm	1256-2020-OSS	1256-2020-OSS-C
20" / 50.8 cm	23" / 58.4 cm	1256-2023-OSS	1256-2023-OSS-C

# Contouring the Spex® Back Support Surface

A special feature of the Spex Back Support is the adjustable contouring cell cube system which incorporates into the upholstery unit of the backrest. Easy configurations are performed for asymmetrical trunk postures without the need for complicated bespoke seating.

The cover un-zips from the top of the back support and remains fixed to the shell while you remove the inner upholstery unit. Changes to the contouring are made on-the-spot for instant results.

Further postural enhancements to the degree and depth of contouring are achieved with the positioning kit of support wedges (included with every Spex Back Support).



Special cover design allows the contouring cube system to be removed through the top of the back support.

## FOR MILD BONY PROMINENCES

Without even adjusting the cube system, the Spex Back Support has slight contouring and integrates a comfortable pressure reducing foam surface layer to absorb mild bony prominences and asymmetries for uniform torso contact.



Showing front pressure-reducing surface

## FOR IMMERSION

For individuals who require immersion into the backrest, simply adjust the cube contouring cell system to configure for a perfect fit and shape for the client's back.

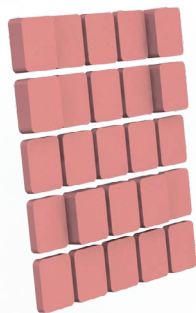

Showing contouring cells without the front foam surface

## FOR ASYMMETRY

For asymmetrical or maladaptive postures, the contour can be arranged to provide the matching shape required to support the client's torso profile.

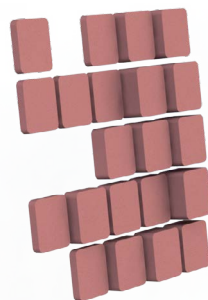

Blank areas show where contouring pads can be fully removed, yet the foam surface still offers padded support



Instant changes can be implemented to configure the back support surface.

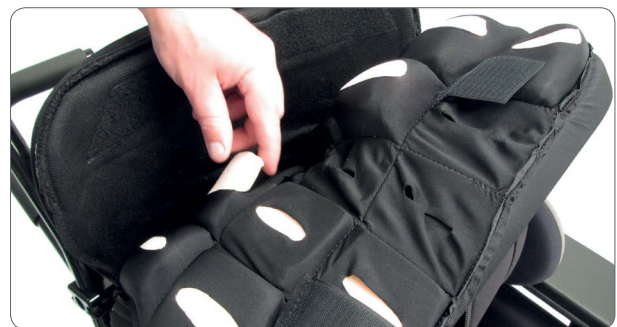

- + Add layers to build up areas where pronounced support is required.
- Remove layers where more immersion is required.



Configurations can be updated at any time when postural needs change. Contouring doesn't move or slip out of adjustment.

# Head Support WHITMYER®

Provide adequate neck and head control simply with the Whitmyer head support system. With their wide array of options for posterior and lateral support of the head and neck, clients with unique needs will always find what they're looking for.

## FUNCTIONAL

- Softly padded foam inner head support with supple upholstery covers
- Powerful clamp mechanism allows super-quick release and prevents lateral movement
- Extra strong and non-wobbly hardware
- Approx. head support weight will vary depending on hardware and support pad choices.
- Each hardware system has a choice of detachable or swing-away mounting brackets for versatility.
- COBRA & COBRA Flip-Back hardware systems include detachable mounting bracket.





## SUPPORT PAD OPTIONS



## HARDWARE SYSTEMS

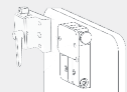
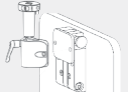
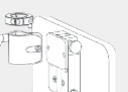
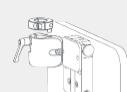

## MOUNTING BRACKETS FOR HARDWARE SYSTEMS

Bracket Style	AXYS Options	ONYX Options	LINX & LINX2 Options	PRO Options
Detachable	 M2500	 M2100-WB	 M2300	 M2200-WB
Swing-Away	 M5500	 M5100	 M5300	 M5200

For more information about Whitmyer's support pad options and hardware system, please refer to the Whitmyer Product Catalog found on the product pages at <http://www.sunrisemedical.ca/seating/whitmyer/headrests>

# Lateral Trunk Supports

Spex lateral trunk supports offer adjustability, comfort and positioning. Our anatomical pad design with new full curved Natural-Lateral® surface has been tested for optimum fitting to body shape. The supporting surface of each lateral pad includes a layer of pressure relieving foam for additional protection and comfort.

## CLINICAL

- Modular lateral supports provide optimum trunk control while improving balance, posture and comfort
- Offset correction can be applied to an asymmetric trunk to bring better trunk alignment for enhanced function

## FUNCTIONAL BENEFITS

- Super comfortable pressure-reduction padding for molding to user shape
- Removable and washable covers
- Brackets are adjustable in all planes: height, width, depth and lateral angle for ultimate trunk orientation
- Spex brings you modular creativity! Mix and match with different pad combinations
- Provide trunk control and stability with the ability to install a lateral in multiple positions on the back support
- Approx. lateral hardware weight is from 0.15 to 0.45 kg (0.33 to 1 lb.), and approx. lateral pad weight is from 0.05 to 0.3 kg (0.11 to 0.66 lb.)

## OPTIONS

- Select from Fixed, Standard Swing-Away or Axial Swing-Away Hardware
- Bracket upgrades available:
  - Cane Mount
  - DeepContour backrest bracket
  - Extension for DeepContour (commonly used with SuperShape backrest)

## AXIAL® TECHNOLOGY

Unique swing-away hardware that allows the lateral pad to rotate to correctly support/align to the user's trunk needs.

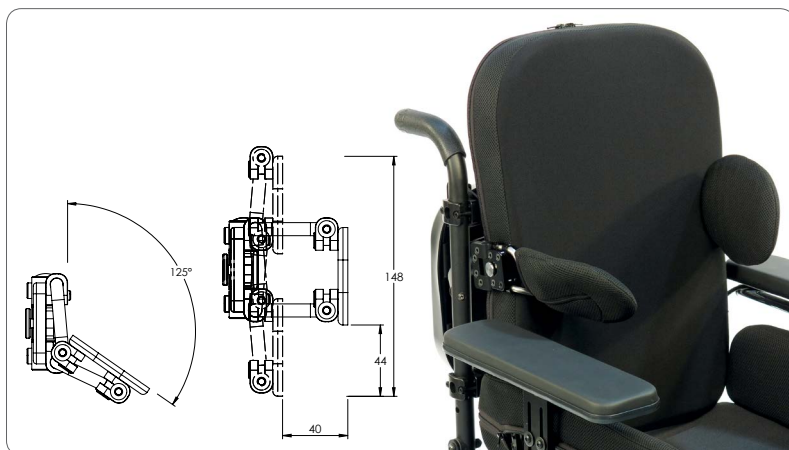

## HARDWARE OPTIONS



**FIXED**  
Width and depth adjustable



**STANDARD SWING-AWAY**  
Width and depth adjustable with vertical pivot adjustment.



**AXIAL® SWING-AWAY**  
Width, depth, and multiple angle adjustable by its rotational system.  
Axial technology provides the correct support structure with patented mechanical rotational system.



**CANE MOUNT**  
Mounts directly to wheelchair canes

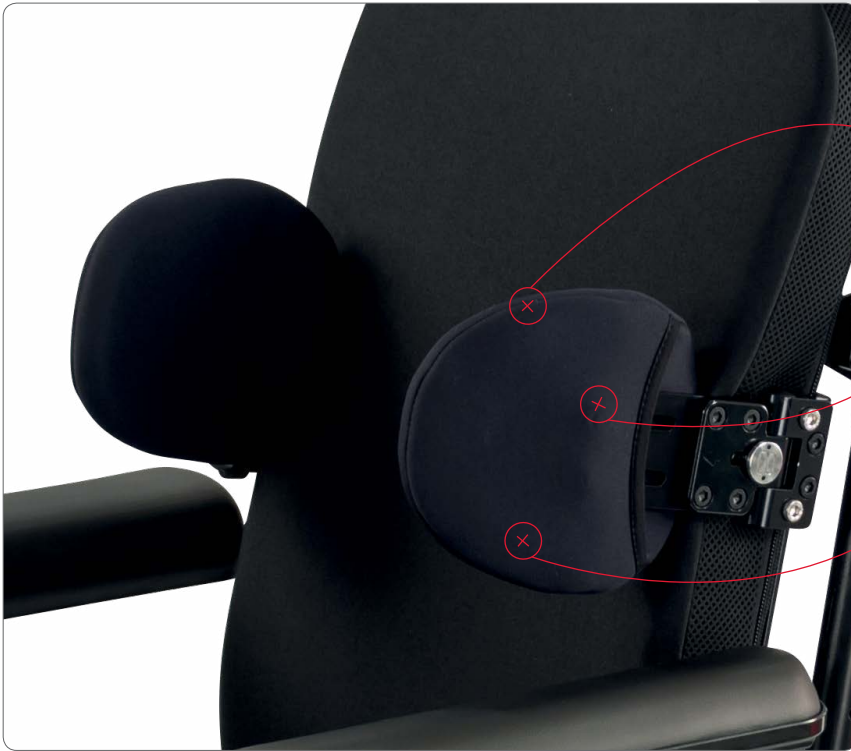

Anatomical full curve  
**NATURAL-LATERAL®** technology  
for optimum fitting to body shape

New levels of comfort with  
**PRESSURE-REDUCING** layer

Huge number of pad options to provide  
the exact **SNUG FITTING** comfort  
that's required (See Page 24)

**FIXED LATERAL  
HARDWARE**

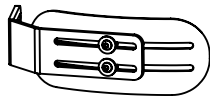

Options (Add pad, shown on Pg 24)	Depth Adjustment	Code
Fixed Bracket	2.2" / 5.5 cm	1266-2101-100
<b>Kidz Fixed Bracket</b>	1.6" / 4 cm	1266-2111-100

**AXIAL LATERAL  
HARDWARE**

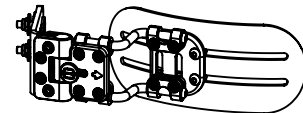

Options (Add pad, shown on Pg 24)	Code
Axial Hardware	1266-2301-100
<b>Kidz Axial Hardware</b>	1266-2311-100

**SWING-AWAY  
LATERAL HARDWARE**

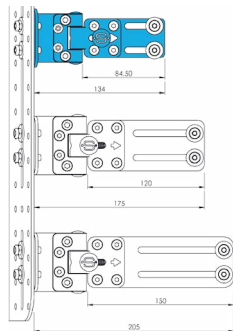
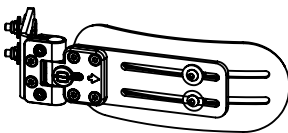

**STANDARD**

Options (Add pad, shown on Pg 24)	Overall length	Plate Length	Code
Swing-Away, straight bracket	6.9" / 17.5 cm	4.7" / 12 cm	1266-2201-100
<b>Swing-Away, kidz straight bracket</b>	5.3" / 13.4 cm	3.4" / 8.5 cm	1266-2211-100
Swing-Away, straight extended bracket	8.1" / 20.5 cm	5.9" / 15 cm	1266-2202-100

**OFFSET**

When lateral support is required  
to sit closer towards the user's  
trunk to provide support

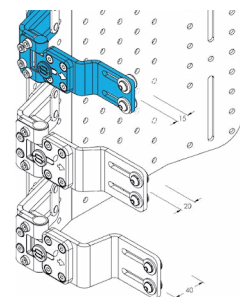

Options (Add pad, shown on Pg 24)	Offset	Code
Swing-Away, offset bracket	0.8" / 2 cm	1266-2203-100
<b>Swing-Away, kidz offset bracket</b>	0.6" / 1.5 cm	1266-2213-100
Swing-Away, offset extended bracket	1.6" / 4 cm	1266-2204-100

# Lateral Support Pads

Anatomical pad design with new full curved Natural-Lateral® surface has been tested for optimum fitting to body shape. Huge lateral support pad range to provide the exact fit required.



## STANDARD COVER

- Pictured above. Removable and washable cover option

## COMFY-COVER

Exclusive Comfy-Covers are available for all laterals (pictured right):

- Extended padding over mechanism to protect arms from the metal hardware
- Clever release strap for operating the swing-away movement
- Easy release for users who have limited hand function and need independent use to open the laterals for transfers

Pad Style	Size	Pad Height	Pad Depth	Pad & Std Cover	Pad & Comfy-Cover
Narrow Straight	0	3.4" / 8.5 cm	4.5" / 11.5 cm	1266-3010-400	1266-3010-800
"	1	3.7" / 9.5 cm	5.7" / 14.5 cm	1266-3011-400	1266-3011-800
"	2	3.7" / 9.5 cm	7.1" / 18 cm	1266-3012-400	1266-3012-800
"	3	4.5" / 11.5 cm	8.3" / 21 cm	1266-3013-400	1266-3013-800
"	4	4.5" / 11.5 cm	9.5" / 24 cm	1266-3014-400	1266-3014-800
Narrow Curved	1	3.7" / 9.5 cm	5.7" / 14.5 cm	1266-3021-400	1266-3021-800
"	2	3.7" / 9.5 cm	7.1" / 18 cm	1266-3022-400	1266-3022-800
"	3	4.5" / 11.5 cm	8.3" / 21 cm	1266-3023-400	1266-3023-800
"	4	4.5" / 11.5 cm	9.5" / 24 cm	1266-3024-400	1266-3024-800
Broad	1	4.1" / 10.5 cm	5.1" / 13 cm	1266-3031-400	1266-3031-800
"	2	4.9" / 12.5 cm	5.5" / 14 cm	1266-3032-400	1266-3032-800
"	3	5.5" / 14 cm	5.9" / 15 cm	1266-3033-400	1266-3033-800
"	4	6.3" / 16 cm	6.1" / 15.5 cm	1266-3034-400	1266-3034-800
"	5	7.7" / 19.5 cm	6.5" / 16.5 cm	1266-3035-400	1266-3035-800
"	6	9.1" / 23 cm	6.9" / 17.5 cm	1266-3036-400	1266-3036-800

## LATERAL PAD OPTIONS



### NARROW STRAIGHT

Freedom to move forwards and backwards for functional activities and transfers



### NARROW CURVED

Anterior support for increased comfort and spinal extension



### BROAD

Provides long trunk support and effective pressure reduction

## COMFY-COVER OPTION





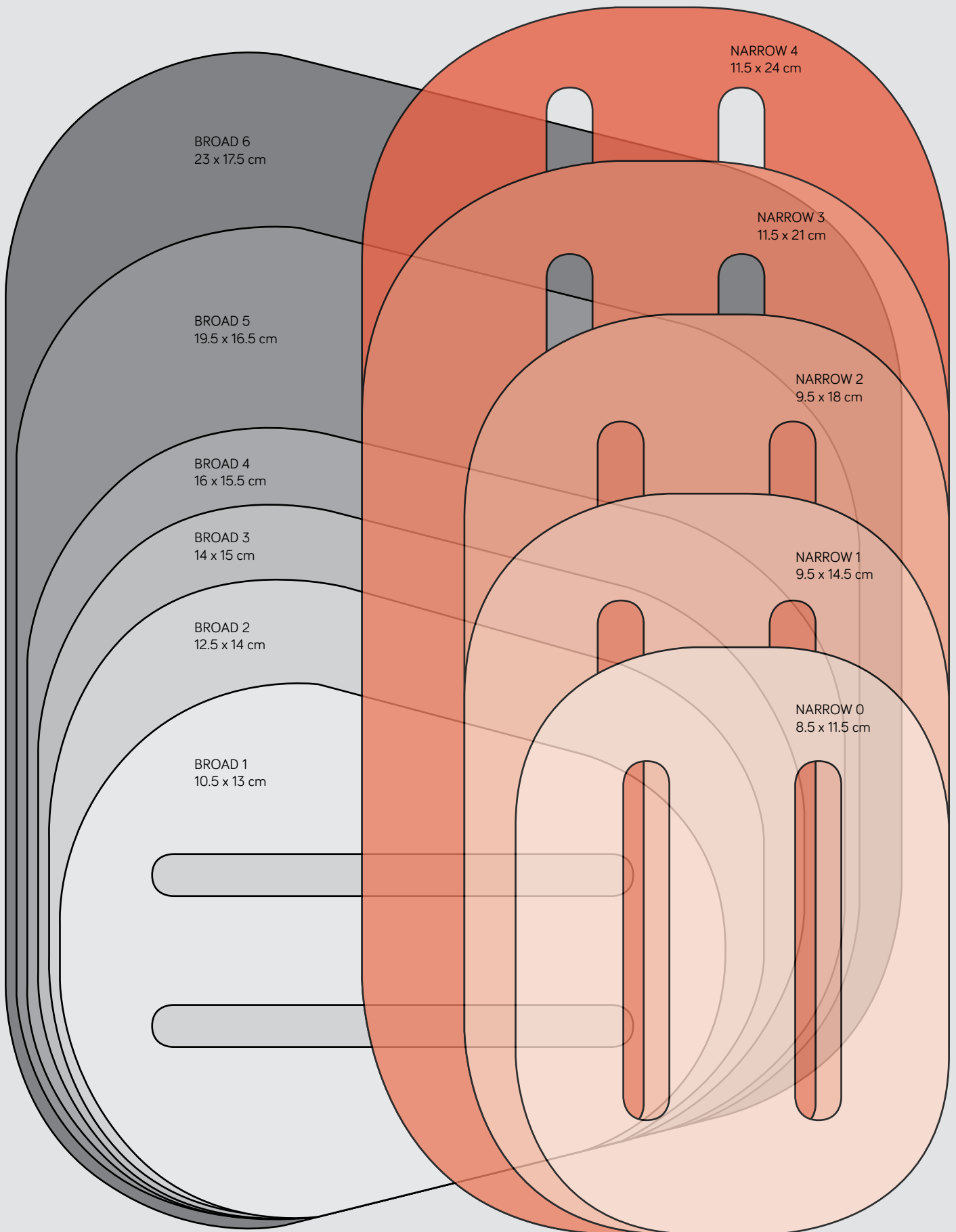

Spex provides the tools to make decisions faster. Use this lateral pad size guide built to scale.

When deciding which lateral support pad style and size will suit your clients, place this page against their torso to make an informed decision on the spot!

# Lateral Thigh Supports

Spex wheelchair thigh supports are transport certified and designed to be installed to the seat pan or seat rail, enabling precise positioning for the user. Various configurations are available including our acclaimed Axial hardware that enables full support for external hip rotation and wind-swept postures as well as preventing pelvic rotation tendency.

## CLINICAL

- Facilitate good thigh alignment and stabilize the sitting posture
- Control hip abduction, moderate external hip rotation, reduce femur and greater trochanter lateral pressure into the wheelchair sideguards with its comfortable pad
- Prevent hip, pelvic and trunk rotation by stabilizing the pelvis on the seating system
- In combination with trunk lateral supports, they assist to align the user's posture, stabilizing upper body and providing functionality

## FUNCTIONAL

- Hardware can be configured various ways to suit different pelvic and thigh patterns
- Arm supports can be upgraded to the hardware if necessary
- Hardware is available in fixed or axial adjustment. Axial hardware reduces the seat width by 0 to 6.5 cm (0 - 2.6") each side. Pad is 2.5 cm (1") thick, and Axial bars allow for up to 4 cm (1.6") adjustment
- Washable upholstery covers

# Arm Supports

Arm supports provide functional forearm and upper extremity support. Modular system creates flexibility and takes into consideration the individual needs of all kinds of clients. Hardware can be combined with thigh support pads, if required.

## CLINICAL

- By having arm supports in the correct position, bearing normal weight on the arm pads will provide better trunk alignment and support which improves posture
- Assist pelvic and trunk stability to reduce or redirect forces that lead to pressure sores
- Correct shoulder girdle stabilizing
- In combination with tray table, they assist to improve upper body stability essential to accomplishing tasks

## FUNCTIONAL

- Spex hardware enables precise positioning of the arm support pads to ensure the user gains the correct positioning for function
- A variety of different hardware options allow specific functions tailored for the user
- Powered chair drive controllers can be easily installed
- Gain accurate width setting and infinite height setting for improved arm placement
- Approx. combo Thigh & Arm Support weight is 1.85 kg (4.07 lbs.)

## FUNCTIONAL CHOICES FOR THIGH & ARM SUPPORTS



- Quick Release



- Flip-Down. Facilitate easy transfers



- Fixed

## ARM SUPPORT CHOICES HEIGHT & ANGLE-ADJUST (PICTURED) OR HEIGHT-ADJUST AVAILABLE



Multiple angle adjustments for precise support.



UNIQUE ANGLE-ADJUSTABLE  
arm support pad option

Support pad can be oriented to  
CORRECTLY ALIGN pelvis/thigh  
positioning

PRESSURE REDUCTION  
pad for comfort at bony areas

Spex Axial technology to maintain  
PRECISE SUPPORT

### SEAT RAIL MOUNT

Option for thigh/arm support hardware. Mounts vertically to the seat rail on most power chairs.

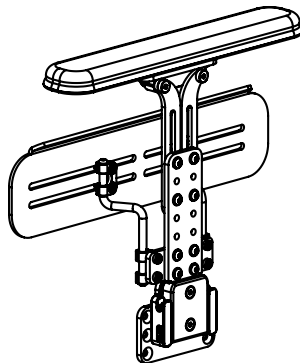

### SEAT PAN MOUNT

Option for thigh/arm support hardware. Mounts horizontally to the seat pan of most wheelchairs.

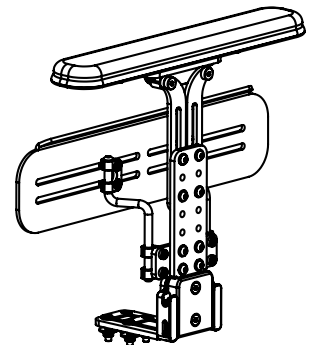

### THIGH SUPPORT PADS

SIZE	WIDTH	DEPTH
10" / 25.4 cm	3" / 7.5 cm	9.8" / 25 cm
12" / 30.5 cm	3.2" / 8 cm	11.8" / 30 cm
14" / 35.6 cm	3.5" / 9 cm	13.8" / 35 cm
16" / 40.6 cm	3.9" / 10 cm	15.8" / 40 cm
18" / 45.7 cm	3.9" / 10 cm	16.9" / 43 cm
20" / 50.8 cm	3.9" / 10 cm	17.7" / 45 cm

### ARM SUPPORT PADS

SIZE	WIDTH	DEPTH
SML, Slim	1.6" / 4 cm	9.8" / 25 cm
MED, Slim	2" / 5 cm	11.8" / 30 cm
LGE, Slim	2.4" / 6 cm	13.8" / 35 cm
SML, Wide	2.8" / 7 cm	9.8" / 25 cm
MED, Wide	3.2" / 8 cm	11.8" / 30 cm
LGE, Wide	3.5" / 9 cm	13.8" / 35 cm

# Medial Thigh Support

The Spex Medial Thigh Support is a wedge shape that can be attached to the front of the wheelchair seat. It should be used to keep the user's legs in the correct position to maintain a neutral pelvis. Provides a comfortable, yet firm, knee and medial thigh support through a soft padding and removable washable cover.



## CLINICAL

- Should be used with clients who experience a variety of movement disorders, fluctuating muscle tone, spasticity or contractures
- Assists to align the heads of the femurs with the acetabulum providing symmetrical hip abduction for proper posture
- Abduction allows equal weight bearing through both ischial tuberosities and thighs, thus permitting better pressure distribution
- Provides a wider, more stable support base for the upper body while limiting contractures and deformities that could interfere with function
- In hip dysplasia cases, luxation or dislocation; provides comfort and reduces pain
- Not to be used as a way to prevent or limit forward sliding. Should be installed clear of the groin area

## FUNCTIONAL

- Depth adjustable convenience combined with flip down hardware, which can then pull off the mount to allow an unimpeded transfer (pull-off feature can be locked with a bolt if not required)
- Easy access release hardware which can be mounted to a seat pan
- Huge height range for high profile cushions

Pad Style	Pad Size	Code	A	B	C	D	E	F
Standard	1	1162-1501-000	2.4" / 6 cm	5.7" / 14.5 cm	3.7" / 9.5 cm	1.6" / 4 cm	1.6" / 4 cm	2.6" / 6.5 cm
"	2	1162-1502-000	2.4" / 6 cm	6.1" / 15.5 cm	3.9" / 10 cm	2.4" / 6 cm	2" / 5 cm	2.6" / 6.5 cm
"	3	1162-1503-000	2.4" / 6 cm	7.3" / 18.5 cm	4.1" / 10.5 cm	2.4" / 6 cm	2.4" / 6 cm	3" / 7.5 cm
Axial-Adjust	1	1162-1601-000	2.8" - 5.5" / 7 - 14 cm	5.7" / 14.5 cm	3.7" / 9.5 cm	2" - 4.7" / 5 - 12 cm	1.6" / 4 cm	2.6" / 6.5 cm
"	2	1162-1602-000	2.8" - 5.5" / 7 - 14 cm	6.1" / 15.5 cm	3.9" / 10 cm	2.4" - 5.5" / 6 - 14 cm	2" / 5 cm	2.6" / 6.5 cm
"	3	1162-1603-000	2.8" - 6.3" / 7 - 16 cm	7.3" / 18.5 cm	4.1" / 10.5 cm	2.4" - 5.5" / 6 - 14 cm	2.4" / 6 cm	3" / 7.5 cm

## PAD OPTIONS

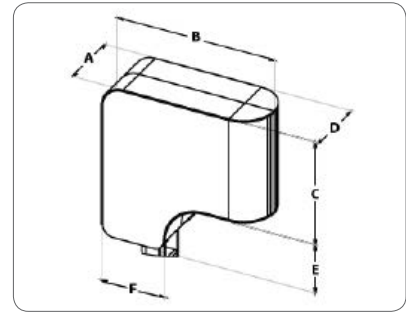

### STANDARD PAD

Refer to table below for size options.

Approx. weight is from 0.8 to 1.1 kg (1.76 to 2.4 lbs.)



### AXIAL-ADJUSTABLE PAD

Shown below without cover. Unique expansion fabric cover allows multiple adjustments.

Offset and swivel for asymmetric positions. Infinite adjustments.

Approx. weight is from 0.95 to 1.25 kg (2.1 to 2.75 lbs.)

# JAY Anterior Positioning

JAY's Anterior Positioning encourages an upright posture and supports the torso for improved respiratory function, head positioning, and upper extremity control. Options include six support styles and either structured or dynamic construction. Each positioning option also provides a different way to remove and attach each set of straps to the client.

## CLINICAL

Depending on the client, the following positioning styles should be used for the following needs:

- The Contour style design is optimized for women or individuals who want to limit the amount of contact area between the harness and the body.
- The Classic style is designed for optimal distribution of support and maximum stability.
- The Zipper Open style is designed to aid in frequent transfers and ease of removal.
- The Center Opening allows for increased flexibility in frequent transfers and the adjustable center strap allows for a more precise fit.
- The Y-Style allows for increased range of motion for one arm while still providing optimal support.
- The Trunk Strap style allows for increased range of motion when shoulder rotation and reaching are required.
- The Backpack style allows control of forward flexion and allows more intimate shoulder retraction – can be used aggressively for upper torso control.

## FUNCTIONAL

- JAY's Anterior Trunk Supports are available with either Structured or Dynamic construction.
- Structured supports provide secure support for individuals who may otherwise experience a decline in proper positioning throughout the day.
- Dynamic Construction helps maintain proper positioning for individuals who may experience periods of high tone or involuntary movements throughout the day.
- Depth, height, and width range all dependent on style of anterior positioning that the client chooses.

## POSITIONING OPTIONS



CLASSIC



CONTOUR STYLE



ZIPPER OPEN



ADJUSTABLE STRETCH,  
CENTER-OPENING

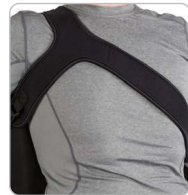

Y-STYLE



BACKPACK STYLE



TRUNK STRAP STYLE

For more information about JAY's anterior positioning options, please refer to the JAY Upper Body Positioning section on our website:  
<http://www.sunrisemedical.ca/seating/jay-positioning/upper-body-positioning>

# JAY Pelvic Positioning

Pelvic Positioning Belts help encourage and maintain a stable and aligned pelvis, which impacts the positioning of the entire body. Options include varying styles and sizes, single- or dual-pull adjustments, and push button or side release buckles for ease of use.

STANDARD 2-POINT WITH  
SIDE RELEASE BUCKLE



STANDARD 2-POINT WITH  
PUSH BUTTON BUCKLE



MEDIAL 4-POINT WITH  
PUSH BUTTON BUCKLE



V-CONTOUR



For more information about JAY's pelvic positioning options, please refer to the JAY Pelvic Positioning section on our website: <http://www.sunrisemedical.ca/seating/jay-positioning/upper-body-positioning>



# Transport Certified

## WC20

The Spex Seating System complies with RESNA WC-4:2012, Section 20. Spex is designed only for use with wheelchair frames that have been successfully crash tested to the frontal-impact requirements of RESNA WC-4:2012, Section 19.

Spex Seating Systems must be used on a wheelchair frame that provides four securement points and pelvic-belt anchor points that conform to the requirements of RESNA WC-4:2012, Section 19.

Spex components that are WC20 certified for use during motor vehicle transportation include: Backrest, Grid-Base Seat Pan, Cushion, Thigh & Arm Supports, Trunk Supports and Head Support. The seating system is designed to be occupied when the wheelchair is facing forward in motor vehicles.

The seating system has been designed to accommodate the proper use of vehicle-anchored belt restraints and the ratings of the seating systems with regard to a) ease of properly positioning vehicle-anchored belt restraints on the wheelchair passenger, and b) the degree to which proper positioning of belt restraints can be achieved.

## ISO 16840-4

Spex Seating is intended only for use with wheelchair bases tested as part of a complete wheelchair system that conforms to the performance requirements of ISO 7176-19.

Spex Seating Systems must be used on a wheelchair base that provides securement points that conform to the design requirements of ISO 7176-19.

Spex components that are ISO 16840-4 certified for use during motor vehicle transportation include: Backrest, Grid-Base Seat Pan, Cushion, Thigh & Arm Supports, Trunk Supports and Head Support. The seating system is designed to be forward facing when used with a wheelchair base in a motor vehicle.

A wheelchair tie down and occupant restraint system (WTORS) that conforms to the requirements of ISO 10542-1 must be used during wheelchair transportation with this seating system.

When tested in accordance with Annex D of ISO 16840-4 with regard to accommodating vehicle-anchored occupant restraints, Spex Seating achieved an overall score of 16 out of 16, and a rating of A (Good).



**Note:** Back supports that are lower than the user's shoulder height are not certified and not recommended for transport in a vehicle. e.g. Vigour Lo and Vigour Mid back supports.

# medifab®

Sunrise Medical Canada Inc.  
237 Romina Drive, Unit 3  
Concord, Ontario  
L4K 4V3  
Canada

Specifications are subject to change without notice.

Customer Service:

Phone: +1 (800) 263 3390

Fax: +1 (800) 561 5834

E-Mail: [cscanada@sunmed.com](mailto:cscanada@sunmed.com)

Website: [www.sunrisemedical.ca](http://www.sunrisemedical.ca)

© 2021 Sunrise Medical Canada Inc.

107739-CAN, REV (F).



CE