



ORDER FORM

Print pages 1-23 to exclude pictures.

Q700M with SEDEO[®] PRO[™], SEDEO LITE[™] AADL - W581 and JAY Syncra Seating EIPW25

| Customer | | Ship To | |
|-----------|--|----------|-------------|
| Account # | | Name | |
| Date | | Address | |
| PO# | | City | |
| Buyer | | Province | Postal Code |
| Mark For | | Phone | |

Client Measurements

| | |
|----------------------------|----|
| a) Top of head to seat | in |
| b) Top of shoulder to seat | in |
| c) Underarm to seat | in |
| d) Elbow to seat | in |
| e) Top of leg to seat | in |
| f) Shoulder width | in |
| g) Chest width | in |
| i) Hip width | in |
| j) Actual sitting depth | in |
| m) Foot length | in |
| n) Knee to foot | in |
| o) Seat width | in |

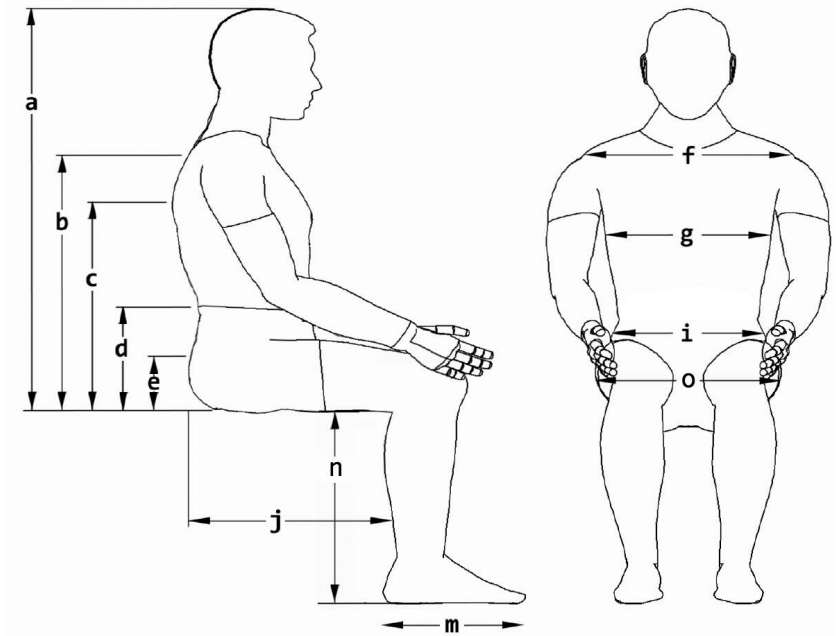

Notes

Chair Specifications

| | |
|--|--|
| Weights Starting at: (with Batteries) | NPC: 294 lbs. SPC: 318 lbs. |
| Power Seating | 50° of CG Tilt 12" seat elevator |
| Seat Type | SEDEO® PRO™/ SEDEO® LITE™/ JAY Syncra |
| Seat Size Range | Width 15" to 20" Depth 16" to 22" |
| Seat-to-Floor Height Range | 16.5" to 19" |

Mid-Wheel Drive Base Specifications

| | |
|--------------------------|--|
| Drive Wheel Position | Mid-wheel drive |
| User Weight Capacity | 250 lbs. / 300 lbs. / 350 lbs. HD / 450 lbs. HD |
| Base Size | Width 25", Length 36.5" |
| Minimum Turning Radius | 19.8" (excludes footplates) |
| Drive Control | R-net PM 120A / R-net PM 90A |
| Driving Range | Up to 18 miles (w/ Group 24 Batteries) |
| Drive Motors | 4-pole 6 mph, 5 mph HD, 8 mph |
| Drive Wheels | 14" w/flat-free inserts (black) 14" w/pneumatic inserts (black) |
| Casters | 6" front / 6" rear (black) |
| Charger | 10A Dual Mode (Compact) |
| Battery Size | Group 24 / Group 34 |
| Color | Matte Black with 6 color accents |
| Maximum Ground Clearance | 3" |

| BASE | | | |
|--|--|---|------------|
| OPTION | | DESCRIPTION | RETAIL |
| Standard Duty Mid Wheel Drive Base <i>End Item Number EIPW25 (PRO™ Seat)</i> | | | \$ |
| 250PC197 | | Quickie Q700 M NPC No Power Option for SEDEO® PRO™ Seat Included in Base Pricing : Q700 M Base, R-net 90amp Electronics for No Power Seat Functions, SpiderTrac 2.0 Six-Wheel Independent Suspension, 14" Drive Wheels with Dual Density Inserts, 6" Flat Free Casters, ISO Occupied Tie-Down Brackets and 10amp Charger. Max Speed = 6mph, Weight Capacity = 300lbs., STFH = 16.5". (AADL Contract Price) | \$8,300.00 |
| 250PC198 | | Quickie Q700 M SPC Single Power Option for SEDEO® PRO™ Seat Included in Base Pricing : Q700 M Base, R-net 90amp Electronics for Single Power Seat Functions, SpiderTrac 2.0 Six-Wheel Independent Suspension, 14" Drive Wheels with Dual Density Inserts, 6" Flat Free Casters, ISO Occupied Tie-Down Brackets and 10amp Charger. Max Speed = 6mph, Weight Capacity = 300lbs., STFH = 16.5". (AADL Contract Price) | \$8,300.00 |
| 250PC198 | | Quickie Q700 M MPC Multi Power Option for SEDEO® PRO™ Seat Included in Base Pricing: Q700 M Base, R-net 90amp Electronics for Multiple Power Seat Functions, SpiderTrac 2.0 Six-Wheel Independent Suspension, 14" Drive Wheels with Dual Density Inserts, 6" Flat Free Casters, ISO Occupied Tie-Down Brackets and 10amp Charger. Max Speed = 6mph, Weight Capacity = 300lbs., STFH = 16.5". (AADL Contract Price) | \$8,300.00 |
| Heavy Duty Mid Wheel Drive Base <i>End Item Number EIPW25 (PRO™ Seat)</i> | | | \$ |
| 250PC199 | | Quickie Q700 M NPC HD No Power Option for SEDEO® PRO™ Seat Included in Base Pricing : Q700 M Base, R-net 90amp Electronics for No Power Seat Functions, SpiderTrac 2.0 Six-Wheel Independent Suspension, 14" Drive Wheels with Dual Density Inserts, 6" Flat Free Casters, ISO Occupied Tie-Down Brackets and 10amp Charger. Max Speed = 5mph, Weight Capacity = 450lbs., STFH = 16.5". (AADL Contract Price) | \$9,200.00 |
| 250PC200 | | Quickie Q700 M SPC HD Single Power Option for SEDEO® PRO™ Seat Included in Base Pricing : Q700 M Base, R-net 90amp Electronics for Single Power Seat Functions, SpiderTrac 2.0 Six-Wheel Independent Suspension, 14" Drive Wheels with Dual Density Inserts, 6" Flat Free Casters, ISO Occupied Tie-Down Brackets and 10amp Charger. Max Speed = 5mph, Weight Capacity = 450lbs., STFH = 16.5". (AADL Contract Price) | \$9,200.00 |
| 250PC204 | | Quickie Q700 M MPC HD Multi Power Option for SEDEO® PRO™ Seat Included in Base Pricing : Q700 M Base, R-net 90amp Electronics for Multi Power Seat Functions, SpiderTrac 2.0 Six-Wheel Independent Suspension, 14" Drive Wheels with Dual Density Inserts, 6" Flat Free Casters, ISO Occupied Tie-Down Brackets and 10amp Charger. Max Speed = 5mph, Weight Capacity = 450lbs., STFH = 16.5". (Client Cost) | \$9,200.00 |
| High Performance 8mph Mid Wheel Drive Base <i>End Item Number EIPW25 (PRO™ Seat)</i> | | | \$ |
| 250PC201 | | Quickie Q700 M NPD HD No Power Option for SEDEO® PRO™ Seat Included in Base Pricing : Q700 M Base, R-net 120amp Electronics for No Power Seat Functions, SpiderTrac 2.0 Six-Wheel Independent Suspension, 14" Drive Wheels with Dual Density Inserts, 6" Flat Free Casters, ISO Occupied Tie-Down Brackets and 10amp Charger. Max Speed = 8mph, Weight Capacity = 300lbs., STFH = 16.5". (Client Cost) | \$9,950.00 |
| 250PC202 | | Quickie Q700 M SPD HD Single Power Option for SEDEO® PRO™ Seat Included in Base Pricing : Q700 M Base, R-net 120amp Electronics for Single Power Seat Functions, SpiderTrac 2.0 Six-Wheel Independent Suspension, 14" Drive Wheels with Dual Density Inserts, 6" Flat Free Casters, ISO Occupied Tie-Down Brackets and 10amp Charger. Max Speed = 8mph, Weight Capacity = 300lbs., STFH = 16.5". (Client Cost) | \$9,950.00 |
| 250PC203 | | Quickie Q700 M MPD HD Multi Power Option for SEDEO® PRO™ Seat Included in Base Pricing : Q700 M Base, R-net 120amp Electronics for Multi Power Seat Functions, SpiderTrac 2.0 Six-Wheel Independent Suspension, 14" Drive Wheels with Dual Density Inserts, 6" Flat Free Casters, ISO Occupied Tie-Down Brackets and 10amp Charger. Max Speed = 8mph, Weight Capacity = 300lbs., STFH = 16.5". (Client Cost) | \$9,950.00 |

| BASE | | | |
|---|--|--|------------|
| OPTION | | DESCRIPTION | RETAIL |
| Standard Duty Mid Wheel Drive Base <i>End Item Number EIPW25 (LITE™ Seat)</i> | | | \$ |
| 250PC267 | | Quickie Q700 M NPC No Power Option for SEDEO® LITE™ Seat Included in Base Pricing : Q700 M Base, R-net 90amp Electronics for No Power Seat Functions, SpiderTrac 2.0 Six-Wheel Independent Suspension, 14" Drive Wheels with Dual Density Inserts, 6" Flat Free Casters, ISO Occupied Tie-Down Brackets and 10amp Charger. Max Speed = 6mph, Weight Capacity = 300lbs., STFH = 16.5". (AADL Contract Price) | \$8,300.00 |
| 250PC268 | | Quickie Q700 M SPC Single Power Option for SEDEO® LITE™ Seat Included in Base Pricing : Q700 M Base, R-net 90amp Electronics for Single Power Seat Functions, SpiderTrac 2.0 Six-Wheel Independent Suspension, 14" Drive Wheels with Dual Density Inserts, 6" Flat Free Casters, ISO Occupied Tie-Down Brackets and 10amp Charger. Max Speed = 6mph, Weight Capacity = 300lbs., STFH = 16.5". (AADL Contract Price) | \$8,300.00 |
| Heavy Duty Mid Wheel Drive Base <i>End Item Number EIPW25 (LITE™ Seat)</i> | | | \$ |
| 250PC269 | | Quickie Q700 M NPC HD No Power Option for SEDEO® LITE™ Seat Included in Base Pricing : Q700 M Base, R-net 90amp Electronics for No Power Seat Functions, SpiderTrac 2.0 Six-Wheel Independent Suspension, 14" Drive Wheels with Dual Density Inserts, 6" Flat Free Casters, ISO Occupied Tie-Down Brackets and 10amp Charger. Max Speed = 5mph, Weight Capacity = 350lbs., STFH = 16.5". (AADL Contract Price) | \$9,200.00 |
| 250PC270 | | Quickie Q700 M SPC HD Single Power Option for SEDEO® LITE™ Seat Included in Base Pricing : Q700 M Base, R-net 90amp Electronics for Single Power Seat Functions, SpiderTrac 2.0 Six-Wheel Independent Suspension, 14" Drive Wheels with Dual Density Inserts, 6" Flat Free Casters, ISO Occupied Tie-Down Brackets and 10amp Charger. Max Speed = 5mph, Weight Capacity = 350lbs., STFH = 16.5". (AADL Contract Price) | \$9,200.00 |
| High Performance 8mph Mid Wheel Drive Base <i>End Item Number EIPW25 (LITE™ Seat)</i> | | | \$ |
| 250PC271 | | Quickie Q700 M NPD No Power Option for SEDEO® LITE™ Seat Included in Base Pricing : Q700 M Base, R-net 90amp Electronics for No Power Seat Functions, SpiderTrac 2.0 Six-Wheel Independent Suspension, 14" Drive Wheels with Dual Density Inserts, 6" Flat Free Casters, ISO Occupied Tie-Down Brackets and 10amp Charger. Max Speed = 8mph, Weight Capacity = 300lbs., STFH = 16.5". (Client Cost) | \$9,950.00 |
| 250PC272 | | Quickie Q700 M SPD Single Power Option for SEDEO® LITE™ Seat Included in Base Pricing : Q700 M Base, R-net 90amp Electronics for Single Power Seat Functions, SpiderTrac 2.0 Six-Wheel Independent Suspension, 14" Drive Wheels with Dual Density Inserts, 6" Flat Free Casters, ISO Occupied Tie-Down Brackets and 10amp Charger. Max Speed = 8mph, Weight Capacity = 300lbs., STFH = 16.5". (Client Cost) | \$9,950.00 |

| BASE | | | | |
|---|--|---|--------------|----------|
| OPTION | | DESCRIPTION | RETAIL | |
| User Weight | | | \$ | |
| 250WG22 | | Up to 250 lbs. | NC | |
| 250WG03 | | 251 to 300 lbs. | NC | |
| 250WG15 | | 301 to 350 lbs. | NC | |
| 250WG25 | | 351 to 450 lbs. | NC | |
| Motor Package | | | \$ | |
| 250PF98 | | 4-pole 8 kph / 5 mph <i>(Standard for Group 3 HD)</i> | NC | |
| 250PF99 | | 4-pole 10 kph / 6 mph <i>(Standard for Group 3)</i> | NC | |
| 250PF101 | | 4-pole 12.5 kph / 8 mph <i>(Upgrade for Group 3)</i> (Client Cost) | \$1,170.00 | |
| Tracking | | | \$ | |
| 250MI01 | | SureTrac® Module & Motor Encoders <i>(Improves drive tracking)</i> | \$1,565.00 | |
| Drive Wheels  P. 24 | | | \$ | |
| 250DW58 | | Drive Wheel, 14", Dual Density, Knobby, Black | NC | |
| 250DW68 | | Drive Wheel, 14", Pneumatic, V-type, Black | \$325.00 | |
| Caster Wheels  P. 24 | | | \$ | |
| 250CW55 | | Caster Wheels 6", Solid, Black | NC | |
| Wheel Locks | | | \$ | |
| 250WL42 | | Wheel Locks | \$105.00 | |
| Shroud Color | | | \$ | |
| | | Color Accents | | |
| 250C119 | | Matte Black | Choose Color | NC |
| 250C125 | | Pearl White | Black | NC |
| 250C165 | | Candy Apple Red | Black | NC |
| 250C166 | | Candy Blue | Black | NC |
| 250C167 | | Candy Purple | Black | NC |
| 250C176 | | Green Apple | Black | NC |
| 250C178 | | Pearl Pink | Black | NC |
| 250C182 | | Silver | Black | NC |
| 250C170 | | American Flag | Black | \$150.00 |
| Color Accents | | | \$ | |
| 250EZ20 | | Apple Green | NC | |
| 250EZ22 | | Black | NC | |
| 250EZ21 | | Blue | NC | |
| 250EZ23 | | Orange | NC | |
| 250EZ24 | | Red | NC | |
| 250EZ19 | | White | NC | |
| 250EZ25 | | Silver | NC | |

| BASE | | | | |
|---|--|--|--|------------|
| OPTION | | DESCRIPTION | | RETAIL |
| ISO Transit Tie Downs | | | | \$ |
| 250T050 | | ISO Transit Package | | NC |
| LED Lights  P. 23 | | | | \$ |
| 250LI04 | | LED Lights and Indicators (Client Cost) | | \$1,131.00 |
| 250LI02 | | Omit LED Lights | | NC |
| Seat Heights | | | | \$ |

Note: Available seat-to-floor heights are dependent on 2 options: **1- Battery Size** and **2- Powered Seating**.
Use the matrix below to determine available ranges for your desired options. Measured from front of seat pan to floor with 0° frame angle.

| | | Seat Height | Power Seating | No Power Seating | |
|----------|--|-------------|---------------|------------------|----|
| 250HT103 | | 16.5" | Group 34 | Group 34 | NC |
| 250HT55 | | 17" | Group 34 | GP24 or GP34 | NC |
| 250HT104 | | 17.5" | Group 34 | GP24 or GP34 | NC |
| 250HT56 | | 18" | GP24 or GP34 | GP24 or GP34 | NC |
| 250HT105 | | 18.5" | GP24 or GP34 | GP24 or GP34 | NC |
| 250HT57 | | 19" | GP24 or GP34 | GP24 or GP34 | NC |

| Batteries and Chargers (AADL Contract Pricing)  P. 24 | | | | \$ |
|---|--|---|--|-----------|
| Group 24 Battery Options (Recommended for max daily range) | | | | |
| 250AG25 | | GP24 Flat Top Pair w/Strap MK Gel | | \$881.00 |
| 250AG26 | | GP24 Flat Top Pair w/Strap Brightway AGM | | \$844.00 |
| Group 34 Battery Options (Required for lower seat-to-floor heights) | | | | |
| 250AG27 | | GP34 Flat Top Pair w/Straps MK Gel | | \$881.00 |
| 250AG29 | | GP34 Flat Top Pair w/Straps Brightway AGM | | \$796.00 |
| Group 22 Battery | | | | |
| 250AG31 | | GP22 Flat Top Pair w/ Straps (N/A with 10A Charger) | | \$626.00 |
| Omit Batteries | | | | |
| 250AG24 | | Battery Harnesses Only (Omit Batteries) | | NC |
| Chargers | | | | |
| 250BJ28 | | 10A Dual Mode (Compact) Power First | | NC |

POWERED SEATING

| OPTION | DESCRIPTION | RETAIL |
|--------|-------------|--------|
|--------|-------------|--------|

Power Seating Options  P. 24 \$
Seat Elevator (Client Cost)

| | | |
|---------|--|------------|
| 250PI07 | Seat Elevator, Powered, 300 mm / 12" (Not available with HD) | \$3,209.00 |
| 250PI08 | C-Me® Seat Elevator, Powered, 300 mm / 12" (Not available with HD model) For users less than 250 lbs. C-Me speed can reach 3 mph. For users 251 to 300 lbs. C-Me speed can reach 2.4 mph. | \$3,209.00 |

Seat Tilt (AADL W993 for Power Tilt)

| | | |
|---------|-----------------------|------------|
| 250PA35 | Posterior 50° Tilt | \$7,995.00 |
| 250PA36 | Posterior 50° HD Tilt | \$8,235.00 |

Seat Recline (AADL W993 for Power Recline)

| | | |
|---------|---|------------|
| 250PA37 | 150° Powered Recline w/ 4" Shear Reduction | \$7,385.00 |
| 250PA38 | 130° Powered Semi-Recline | \$6,885.00 |
| 250PA39 | 150° HD Powered Recline w/ 4" Shear Reduction) | \$8,235.00 |

Seat Tilt/Recline (AADL W993 for Power Tilt and Recline)

| | | |
|---------|--|-------------|
| 250PA41 | Posterior 50° Tilt and 150° Recline Powered, w/ 4" Shear Reduction | \$12,252.00 |
| 250PA42 | Posterior 50° Tilt and 130° Semi-Recline Powered | \$11,752.00 |
| 250PA43 | Posterior 50° HD Tilt and 150° HD Recline Powered, w/ 4" Shear Reduction | \$13,282.00 |

Pre Set Seat Frame Angle (No Power Seating Options, Increases Seat to Floor Height) \$

| | | |
|---------|----------------------|----|
| 250FA10 | 0° (Adds 0" to STFH) | NC |
| 250FA3 | 3° (Adds 1" to STFH) | NC |
| 250FA4 | 6° (Adds 2" to STFH) | NC |
| 250FA5 | 9° (Adds 3" to STFH) | NC |

Backrest Frame Type \$

| | | |
|---------|---|----------|
| 250BF10 | Tool Angle Adjustable Back, 90°-120° | NC |
| 250BF11 | User Adjustable Manual Semi-Recline Back, 90°-130°, Right (Adjustment Lever Mounted on Opposite Side of Joystick) | \$760.00 |
| 250BF12 | User Adjustable Manual Semi-Recline Back, 90°-130°, Left (Adjustment Lever Mounted on Opposite Side of Joystick) | \$760.00 |

Backrest Frame Option \$

| | | |
|---------|--------------------------|----------|
| 250BF23 | Flip Down, Quick Release | \$165.00 |
|---------|--------------------------|----------|

Back Cushion Type \$

| | | |
|----------|---|----------|
| 250BT134 | SEDEO® Back Cushion (Choose Seating in Section B) | NC |
| 250BT148 | SEDEO® LITE™ Sling Back with Tension Adjustable Straps (Choose Seating in Section A) | NC |
| 250BT134 | JAY® Syncra™ (Choose Seating in Section C) | NC |
| 250BT135 | JAY® J3® (Choose Seating in Section D) | NC |
| 250BT136 | JAY® J3® Interface Only (Allows Personalized JAY Backs) | NC |
| 250BT137 | SEDEO® PRO™ Aftermarket Back Adapter (Height Adjustable Round Tubes for Traditional Mounting) | \$585.00 |
| 250BT133 | OMIT (For personalized mounting. No headrest mount) | NC |

| POWERED SEATING | | | | | | | |
|--|--|--|------------------------|---------------------|---------------------|------------------------------|----|
| OPTION | | DESCRIPTION | | RETAIL | | | |
| A - SEDEO® LITE™ Backrest Frame (Angle Adjustable 86° - 106°) | | | | \$ | | | |
| Back Frame Width | | | | | | | |
| 250BF21 | | Width Adjustable, 385 - 485 mm / 15" - 19" | | NC | | | |
| 250BF22 | | Width Adjustable, 460 - 510 mm / 18" - 20" | | NC | | | |
| Back Cane Height | | | | | | | |
| 250B263 | | Standard, 18" - 20" | | NC | | | |
| 250B264 | | Tall, 21" - 23" | | NC | | | |
| Backrest Frame Options | | | | \$ | | | |
| 250BF23 | | Flip Down, Quick Release | | \$165.00 | | | |
| 250BF24 | | Removeable | | NC | | | |
| 250PH30 | | Height Adjustable, Short w/ Trailing Push Handles <i>(Push Handle Height 20" - 22", N/A w/ Sling Back)</i> | | NC | | | |
| 250PH31 | | Height Adjustable, Tall w/ Trailing Push Handles <i>(Push Handle Height 23 - 26", N/A w/ Sling Back)</i> | | NC | | | |
| A - SEDEO® LITE™ Sling Back Dimensions | | | | | | | |
| Installed Back Height - (From Pan to Top of Back) | | | | | | | |
| 250JR71 | | 18" | | NC | | | |
| 250JR72 | | 19" | | NC | | | |
| 250JR73 | | 20" | | NC | | | |
| 250JR74 | | 21" | | NC | | | |
| 250JR75 | | 22" | | NC | | | |
| 250JR76 | | 23" | | NC | | | |
| B - SEDEO® Backrest Dimensions (Seating Benefits) | | | | | | | |
| Back Width | | | | | | | |
| 250BN28 | | 400mm / 16" | | NC | | | |
| 250BN29 | | 460mm / 18" | | NC | | | |
| 250BN30 | | 500mm / 20" | | NC | | | |
| 250BN31 | | 560mm / 22" | | NC | | | |
| Back Shell Height | | | | | | | |
| | | | Tool Angle Adj. | 130° Recline | 150° Recline | Installed Back Height | |
| 250B255 | | 460mm / 18" | 22" - 23" | 22"-24" | 23"-25" | | NC |
| 250B256 | | 560mm / 22" | 24" - 27" | 25" - 27" | 26"-29" | | NC |
| 250B257 | | 660mm / 26" | 28" - 30" | 28" - 30" | 30" | | NC |
| Installed Back Height - (From Pan to Top of Back) | | | | | | | |
| 250JR32 | | 22" | | | | NC | |
| 250JR33 | | 23" | | | | NC | |
| 250JR34 | | 24" | | | | NC | |
| 250JR35 | | 25" | | | | NC | |
| 250JR36 | | 26" | | | | NC | |
| 250JR37 | | 27" | | | | NC | |
| 250JR38 | | 28" | | | | NC | |
| 250JR39 | | 29" | | | | NC | |
| 250JR40 | | 30" | | | | NC | |

POWERED SEATING

| OPTION | DESCRIPTION | RETAIL |
|--------|-------------|--------|
|--------|-------------|--------|

Lateral Thoracic Support Pads

| | | |
|---------|--|---------|
| 250KD31 | Lateral, Swing-Away, Adjustable, Long Pad 150 x 130 mm / 6" x 5" , Right | \$67.00 |
| 250KD32 | Lateral, Swing-Away, Adjustable, Long Pad 150 x 130 mm / 6" x 5" , Left | \$67.00 |
| 250KD33 | Lateral, Swing-Away, Adjustable, Short Pad 90 x 120 mm / 3.5" x 4.5" , Right | \$67.00 |
| 250KD34 | Lateral, Swing-Away, Adjustable, Short Pad 90 x 120 mm / 3.5" x 4.5" , Left | \$67.00 |

Lateral Thoracic Swing-Away Hardware

| | | |
|---------|------------------------------------|----------|
| 250KE45 | Lateral Swing-Away Hardware, Right | \$300.00 |
| 250KE46 | Lateral Swing-Away Hardware, Left | \$300.00 |

C- JAY® Syncra™ Back (Seating Benefits) NEW \$

| | | |
|---------|---|------------|
| 250JP14 | JAY® Syncra™ Back 16-20" Wide with 3" Contour Depth | \$1,250.00 |
| 250JP15 | JAY® Syncra™ Back 22" Wide with 3" Contour Depth | \$1,250.00 |

C - JAY® Syncra™ Back Width NEW \$

Back can be ordered a different width than seat pan. Armrest will be adjusted to back width ordered.

| | | |
|---------|---|----|
| 250JQ07 | 16" Wide (Adjustment range 16 to 17" Wide)* | NC |
| 250JQ08 | 18" Wide (Adjustment range 18 to 19" Wide)* | NC |
| 250JQ09 | 20" Wide (Adjustment range 20 to 21" Wide)* | NC |
| 250JQ10 | 22" Wide (Adjustment range 22 to 23" Wide)* | NC |

**Additional +1" of shell width adjustment is achievable. Requires purchase of 1" larger foam and upholstery separately.*

C - JAY® Syncra™ Back Shell Options and Height Ranges NEW \$

JAY® Syncra™ Back shells are mounted with a minimim 5.5" gap between the bottom of the shell to the seat pan to accommodate the mechanical shear. Back height can be adjusted in the field with-in the ranges shown based on the back frame type.

JAY® Syncra™ Shell Height

| | | |
|---------|---|----|
| 250JR42 | 16" Tall Shell (22" to 24" Back Height) | NC |
| 250JR43 | 18" Tall Shell (24" to 26" Back Height) | NC |
| 250JR44 | 20" Tall Shell (26" to 28" Back Height) | NC |
| 250JR45 | 22" Tall Shell (28" to 30" Back Height) | NC |

JAY® Syncra™ Back Installed Back Height (From Pan to Top of Back)

| | | |
|---------|------------------------|----|
| 250JR50 | 22" (16" Shell Height) | NC |
| 250JR51 | 23" (16" Shell Height) | NC |
| 250JR52 | 24" (16" Shell Height) | NC |
| 250JR53 | 24" (18" Shell Height) | NC |
| 250JR54 | 25" (18" Shell Height) | NC |
| 250JR55 | 26" (18" Shell Height) | NC |
| 250JR56 | 26" (20" Shell Height) | NC |
| 250JR57 | 27" (20" Shell Height) | NC |
| 250JR58 | 28" (20" Shell Height) | NC |
| 250JR67 | 28" (22" Shell Height) | NC |
| 250JR68 | 29" (22" Shell Height) | NC |
| 250JR69 | 30" (22" Shell Height) | NC |

C - JAY® Syncra™ Back Upholstery

| | | |
|---------|-----------------------------|----|
| 250BU96 | Syncra™ Premium Leatherette | NC |
| 250BU97 | Syncra™ Stretch | NC |
| 250BU98 | Syncra™ 3DX Microclimatic | NC |

POWERED SEATING

| OPTION | DESCRIPTION | RETAIL |
|---|--|------------|
| D - JAY® J3® Back - Contour (Seating Benefits)  P. 24 \$ | | |
| 250JP01 | J3® PA Back for 16"-20" Wide | \$852.00 |
| 250JP02 | J3® PA Back for 22" Wide | \$1,812.00 |
| 250JP11 | J3® PL Back for 16"-20" Wide | \$920.00 |
| 250JP13 | J3® PD Back for 16"-20" Wide (18" and 21" shell height only) | \$997.00 |

D - JAY® J3® Back Width \$

Back can be ordered a different width than seat pan. Armrest will be adjusted to back width ordered.

| | | |
|---------|-----|----|
| 250JQ02 | 16" | NC |
| 250JQ03 | 18" | NC |
| 250JQ04 | 20" | NC |
| 250JQ05 | 22" | NC |

D - JAY® J3® Back Shell Options and Height Ranges \$

JAY® J3® shells are mounted with a minimim 4" gap between the bottom of the shell to the seat pan to accommodate the mechanical shear. Back height can be adjusted in the field within the ranges shown, based on the back frame type and the amount of usable hardware adjustability.

JAY® J3® Shell Height

| | | Tool Angle Adj. | 130° Recline | 150° Recline | | |
|---------|--|-----------------|--------------|--------------|-----------------------|----|
| 250JR41 | 15" tall shell (Upper Thoracic Med) for 22" Wide | 22" - 23" | 21" - 22" | 22" - 23" | Installed Back Height | NC |
| 250JR14 | 16.5" tall shell (Upper Thoracic Short) | 21" - 23" | 21" - 22" | 21" - 23" | | NC |
| 250JR15 | 18" tall shell (Upper Thoracic Med) | 22" - 24" | 22" - 24" | 23" - 25" | | NC |
| 250JR16 | 19.5" tall shell (Upper Thoracic Tall) | 24" - 26" | 24" - 26" | 24" - 26" | | NC |
| 250JR18 | 18" tall shell (Shoulder Height) for 22" Wide | 25" - 26" | 24" - 25" | 25" - 26" | | NC |
| 250JR17 | 21" tall shell (Shoulder Height) | 24" - 26" | 25" - 27" | 26" - 28" | | NC |
| 250JR27 | 22.5" tall shell (Shoulder Height) | 26" - 28" | 27" - 29" | 27" - 29" | | NC |
| 250JR28 | 24" tall shell (Shoulder Height) | 27" - 29" | 28" - 30" | 29" - 30" | | NC |

JAY® J3® Installed Back Height (From Pan to Top of Back)

| | | |
|---------|-----|----|
| 250JR29 | 21" | NC |
| 250JR19 | 22" | NC |
| 250JR20 | 23" | NC |
| 250JR21 | 24" | NC |
| 250JR22 | 25" | NC |
| 250JR23 | 26" | NC |
| 250JR24 | 27" | NC |
| 250JR25 | 28" | NC |
| 250JR30 | 29" | NC |
| 250JR31 | 30" | NC |

D - JAY® J3® Back Spine-Align Fit Kit 2 (Seating Benefits)  P. 24 \$

| | | |
|---------|--------------|----------|
| 250JS02 | 410 mm / 16" | \$202.00 |
| 250JS03 | 460 mm / 18" | \$202.00 |
| 250JS04 | 510 mm / 20" | \$202.00 |

POWERED SEATING

| OPTION | DESCRIPTION | RETAIL |
|--------|-------------|--------|
|--------|-------------|--------|

D - JAY® Anterior Thoracic Support (Seating Benefits)  P. 25 \$

Classic-Structure Pull Down Harness (4 point strap, only available with JAY® backrest)

| | | |
|--------|-----------------------|----------|
| 250K10 | Medium (ATS8302) | \$300.00 |
| 250K11 | Large (ATS8303) | \$300.00 |
| 250K12 | Extra Large (ATS8304) | \$300.00 |

D - JAY® J3® Lateral Thoracic Swing-Away Supports (Seating Benefits) \$
Lateral Thoracic Support Pads

| | | |
|---------|--|---------|
| 250JW19 | Lateral Thoracic (LxH) 100 mm x 100 mm / 4" x 4" Pad - Right | \$67.00 |
| 250JW25 | Lateral Thoracic (LxH) 100 mm x 100 mm / 4" x 4" Pad - Left | \$67.00 |
| 250JW20 | Lateral Thoracic (LxH) 100 mm x 127 mm / 4" x 5" Pad - Right | \$67.00 |
| 250JW26 | Lateral Thoracic (LxH) 100 mm x 127 mm / 4" x 5" Pad - Left | \$67.00 |
| 250JW21 | Lateral Thoracic (LxH) 100 mm x 152 mm / 4" x 6" Pad - Right | \$67.00 |
| 250JW27 | Lateral Thoracic (LxH) 100 mm x 152 mm / 4" x 6" Pad - Left | \$67.00 |
| 250JW22 | Lateral Thoracic (LxH) 152 mm x 100 mm / 6" x 4" Pad - Right | \$67.00 |
| 250JW28 | Lateral Thoracic (LxH) 152 mm x 100 mm / 6" x 4" Pad - Left | \$67.00 |
| 250JW23 | Lateral Thoracic (LxH) 152 mm x 127 mm / 6" x 5" Pad - Right | \$67.00 |
| 250JW29 | Lateral Thoracic (LxH) 152 mm x 127 mm / 6" x 5" Pad - Left | \$67.00 |
| 250JW24 | Lateral Thoracic (LxH) 152 mm x 152 mm / 6" x 6" Pad - Right | \$67.00 |
| 250JW30 | Lateral Thoracic (LxH) 152 mm x 152 mm / 6" x 6" Pad - Left | \$67.00 |

Lateral Thoracic Swing-Away Fabric

| | | |
|---------|-----------------------------|---------|
| 250NU01 | Syncra™ Premium Leatherette | \$67.00 |
| 250NU02 | Syncra™ Stretch | \$67.00 |
| 250NU03 | Syncra™ 3DX Microclimatic | \$67.00 |

Lateral Thoracic Swing-Away Hardware

| | | |
|---------|---|----------|
| 250JW31 | Lateral Thoracic Swing-Away Bracket - Right | \$300.00 |
| 250JW32 | Lateral Thoracic Swing-Away Bracket - Left | \$300.00 |

Headrests (Requires Pad, Upholstery, & Mount) (Seating Benefits)  P. 25 \$
Headrest Pad

| | | |
|---------|--|----------|
| 250HE36 | SEDEO® Pad Small With Cover (LxH) 240 x 150 mm / 10" x 6" <i>Can only be used with Multi Position Headrest Mount with Quick Release and SEDEO® Upholstery</i> | \$210.00 |
| 250HE37 | SEDEO® Pad Flexible, (LxH) 400 x 110 mm / 16" x 4.5" <i>Can only be used with Multi Position Headrest Mount with Quick Release and SEDEO® Upholstery</i> | \$340.00 |
| 250HE38 | Whitmyer® Plush Headrest Pad 203 mm / 8" | \$328.00 |
| 250HE39 | Whitmyer® Plush Headrest Pad 254 mm / 10" | \$328.00 |
| 250HE44 | Whitmyer® Plush Headrest Pad 356 mm / 14" | \$328.00 |
| 250HE45 | Whitmyer® Adjust-A-Plush Headrest Pad Small (Narrow) (Adjustable from 6 to 14" Wide x 3" Tall) | \$387.00 |
| 250HE46 | Whitmyer® Adjust-A-Plush Headrest Pad Medium (Adjustable from 7 to 16" Wide x 4" Tall) | \$387.00 |
| 250HE47 | Whitmyer® Adjust-A-Plush Headrest Pad Large (Standard) (Adjustable from 8 to 18" Wide x 5" Tall) | \$387.00 |
| 250HE48 | OMIT Headrest Pad | NC |

| POWERED SEATING | | | |
|---|--|--|----------|
| OPTION | | DESCRIPTION | RETAIL |
| Headrest Pad Upholstery | | | |
| 250NU10 | | SEDEO® Upholstery | NC |
| 250NU04 | | Syncra™ Premium Leatherette | NC |
| 250NU05 | | Syncra™ Premium Leatherette | NC |
| 250NU06 | | Syncra™ Premium Leatherette | NC |
| 250NU11 | | Whitmyer® Lycra | NC |
| Headrest Mount | | | |
| 250MH32 | | SEDEO® Multi-Position Headrest Mount with Quick Release <i>(Only available with SEDEO® Pad)</i> | \$515.00 |
| 250MH33 | | Whitmyer® Linx Headrest Mount with Quick Release | \$215.00 |
| 250MH34 | | Whitmyer® Linx-2 Headrest Mount with Quick Release | \$260.00 |
| 250MH35 | | Whitmyer® AXYS Headrest Mount with Quick Release | \$215.00 |
| 250MH36 | | Whitmyer® AXYS Offset Headrest Mount with Quick Release | \$215.00 |
| 250MH37 | | Whitmyer® Cobra FB Headrest Mount with Quick Release | \$515.00 |
| 250MH17 | | OMIT Headrest Mount | NC |
| Push Handles €\$ | | | |
| 250PH27 | | Height Adjustable Push Handles | \$57.00 |
| Seat Frame Rails €\$ | | | |
| 250SN14 | | Seat Rail Short, For Seat Depth 16" - 20" <i>(Effective depth 14" to 18")</i> | NC |
| 250SN15 | | Seat Rail Long, For Seat Depth 19" - 22" <i>(Effective depth 17" to 20") (Not available with 16" seat width)</i> | NC |
| Seat Cushion Type €\$ | | | |
| 250ST78 | | SEDEO® (See Section D) | NC |
| 250ST79 | | JAY Syncra™ (See Section F) | NC |
| 250ST80 | | JAY® (See Section E) | NC |
| 250ST75 | | Omit | NC |
| Seat Size €\$ | | | |
| Seat Pan Width | | | |
| 250R78 | | 15" <i>(Not Available with Sedeo PRO)</i> | NC |
| 250R53 | | 16" | NC |
| 250R54 | | 17" | NC |
| 250R55 | | 18" | NC |
| 250R56 | | 19" | NC |
| 250R57 | | 20" | NC |
| 250R58 | | 21" <i>(Not Available with JAY® Syncra Cushions or Sedeo Lite)</i> | NC |
| 250R59 | | 22" <i>(Not Available with Sedeo Lite)</i> | NC |
| Seat Pan Depth (Front of Seat Pan to Back Structure. Back Cushions Can Cause 2" Loss of Effective Depth) | | | |
| 250RF51 | | 16" | NC |
| 250RF45 | | 17" | NC |
| 250RF46 | | 18" | NC |
| 250RF47 | | 19" | NC |
| 250RF48 | | 20" | NC |
| 250RF49 | | 21" | NC |
| 250RF50 | | 22" | NC |
| SEDEO® Cushions (Seating Benefits) €\$ | | | |
| 250CU82 | | SEDEO® Cushion <i>(Sizes 16", 18", & 20" Wide) (Not Available with 14" Depth)</i> | \$295.00 |
| 250CU83 | | SEDEO® Cushion <i>(Sizes 22" Wide)</i> | \$295.00 |

| POWERED SEATING | | | |
|---|-----------------------------|--|----------------|
| OPTION | | DESCRIPTION | RETAIL |
| E - JAY® Seat Cushions (Seating Benefits) | | | \$ |
| 250CU55 | | JAY® X2® Cushion (Sizes 16" - 20" Wide) | \$881.00 |
| 250CU56 | | JAY® J2® Cushion (Sizes 16" - 20" Wide) | \$777.00 |
| 250CU57 | | JAY® J2® Deep Contour Cushion (Sizes 16" - 20" Wide) | \$812.00 |
| 250CU58 | | JAY® J2® Deep Contour Cushion (Size 22" Wide) | \$1,021.00 |
| 250CU59 | | JAY® Ion® (Sizes 16" - 21" Wide) | \$613.00 |
| 250CU60 | | JAY® Ion® (Size 22" Wide) | \$652.00 |
| 250CU61 | | JAY® Union® (Sizes 16" - 21" Wide) | \$714.00 |
| 250CU62 | | JAY® Union® (Size 22" Wide) | \$753.00 |
| 250CU63 | | JAY® Union® Reduced Profile (Sizes 16" - 20" Wide) | \$714.00 |
| 250CU64 | | JAY® Fusion® with Cryo® Technology (Sizes 16" - 21" Wide) | \$976.00 |
| 250CU65 | | JAY® Fusion® with Cryo® Technology (Size 22" Wide) | \$1,095.00 |
| 250CU66 | | JAY® Fusion® Air Insert Single Valve (Sizes 16" - 21" Wide) | \$992.00 |
| 250CU67 | | JAY® Fusion® Air Insert Single Valve (Size 22" Wide) | \$1,111.00 |
| 250CU68 | | JAY® Fusion® Air Insert Dual Valve (Sizes 16" - 21" Wide) | \$976.00 |
| 250CU69 | | JAY® Fusion® Air Insert Dual Valve (Size 22" Wide) | \$1,095.00 |
| 250CU70 | | JAY® Fusion® Reduced Profile (Sizes 16" - 21" Wide) | \$976.00 |
| 250CU71 | | JAY® Fusion® Reduced Profile with Cryo® Technology (Sizes 16" - 21" Wide) | \$1,095.00 |
| 250CU72 | | JAY® Fusion® Reduced Profile Air Insert Single Valve (Sizes 16" - 21" Wide) | \$976.00 |
| 250CU73 | | JAY® Fusion® Reduced Profile Air Insert Dual Valve (Sizes 16" - 21" Wide) | \$1,095.00 |
| 250CU74 | | JAY® Fusion® Reduced Profile Air Insert Dual Valve (Sizes 16" - 21" Wide) | \$992.00 |
| 250CU75 | | JAY® Fusion® Reduced Profile Air Insert Dual Valve (Size 22" Wide) | \$1,111.00 |
| 250CU76 | | JAY® Fusion® Positioning (Sizes 16" - 21" Wide) | \$997.00 |
| 250CU77 | | JAY® Fusion® Positioning (Size 22" Wide) | \$1,108.00 |
| 250CU78 | | JAY® Fusion® Positioning Air Insert Single Valve (Sizes 16" - 21" Wide) | \$1,019.00 |
| 250CU79 | | JAY® Fusion® Positioning Air Insert Dual Valve (Sizes 16" - 21" Wide) | \$1,120.00 |
| 250CU80 | | JAY® Fusion® Positioning Air Insert Dual Valve (Sizes 16" - 21" Wide) | \$1,019.00 |
| 250CU81 | | JAY® Fusion® Positioning Air Insert Dual Valve (Size 22" Wide) | \$1,120.00 |
| E - JAY® Solid Seat (Seating Benefits) | | | \$ |
| 250CU84 | | JAY® Solid Seat | \$325.00 |
| E - JAY® Bundling | | | \$ |
| <i>Note: To order any JAY® cushion not listed above please see the JAY® price list.</i> | | | |
| 250JC20 | JAY® Bundled Cushion | | See Price List |
| | Cushion name or part number | Width | Depth |
| F - JAY® Syncra Cushions (Seating Benefits) | | | \$ |
| 250CU87 | | JAY® Syncra™ Cushion with Visco Foam (16" to 20" wide) | \$950.00 |
| 250CU88 | | JAY® Syncra™ Cushion with Visco Foam (22" wide) | \$950.00 |
| 250CU89 | | JAY® Syncra™ Cushion featuring JAY Flow® Fluid with Cryo™ Technology (16" to 20" wide) | \$950.00 |
| 250CU90 | | JAY® Syncra™ Cushion featuring JAY Flow® Fluid with Cryo™ Technology (22" wide) | \$1,050.00 |
| 250CU91 | | JAY® Syncra™ Cushion with Air Insert - Single Valve (16" to 20" wide) | \$1,050.00 |
| 250CU92 | | JAY® Syncra™ Cushion with Air Insert - Single Valve (22" wide) | \$1,050.00 |
| 250CU93 | | JAY® Syncra™ Cushion with Air Insert - Dual Valve (16" to 20" wide) | \$1,050.00 |
| 250CU94 | | JAY® Syncra™ Cushion with Air Insert - Dual Valve (22" wide) | \$1,050.00 |
| JAY® Syncra™ Cushion Cover Upholstery | | | |
| 250YR73 | | Syncra™ Premium Leatherette | NC |
| 250YR74 | | Syncra™ Stretch | NC |
| 250YR75 | | Syncra™ 3DX Microclimatic | NC |

POSITIONING SUPPORTS & ACCESSORIES

| OPTION | DESCRIPTION | RETAIL |
|--------|-------------|--------|
|--------|-------------|--------|

Knee and Thigh Swing-Away Support Pads **(Seating Benefits)**

\$

Lateral Knee Support Pads and Hardware *(must pick pad and mount)*

| | | |
|---------|--|----------|
| 250XY05 | Lateral Knee Support Pad, Right (4" round) | \$228.00 |
| 250XY06 | Lateral Knee Support Pad, Left (4" round) | \$228.00 |
| 250XX08 | Lateral Swing-Away Bracket Knee - Right | \$300.00 |
| 250XX09 | Lateral Swing-Away Bracket Knee - Left | \$300.00 |

Lateral Thigh Support Pads and Hardware *(must pick pad and mount)*

| | | |
|---------|---|----------|
| 250KF08 | Lateral Thigh Support Pad, Right (5"x10") | \$134.00 |
| 250KF09 | Lateral Thigh Support Pad, Left (5"x10") | \$134.00 |
| 250KF10 | Lateral Removable Bracket Thigh - Right | \$300.00 |
| 250KF11 | Lateral Removable Bracket Thigh - Left | \$300.00 |

JAY® Lateral Thigh Supports (Must pick pad, upholstery, and mount) **(Seating Benefits)**

\$

JAY® Lateral Thigh Support Pads

| | | |
|---------|---|----------|
| 250KF16 | Lateral Thigh Support Standard, Right (8.25" x 3.25") | \$134.00 |
| 250KF17 | Lateral Thigh Support Standard, Left (8.25" x 3.25") | \$134.00 |
| 250KF18 | Lateral Thigh Support Large, Right (12" x 3.25") | \$134.00 |
| 250KF19 | Lateral Thigh Support Large, Left (12" x 3.25") | \$134.00 |

JAY® Lateral Thigh Support Pad Upholstery

| | | |
|---------|-----------------------------|----|
| 250NU07 | Syncra™ Premium Leatherette | NC |
| 250NU08 | Syncra™ Stretch | NC |
| 250NU09 | Syncra™ 3DX Microclimatic | NC |

JAY® Lateral Thigh Removable Mount

| | | |
|---------|---------------------------------------|----------|
| 250KF20 | Lateral Thigh Removable Mount - Right | \$300.00 |
| 250KF21 | Lateral Thigh Removable Mount - Left | \$300.00 |

Armrest Structure P. 26

\$

| | | |
|---------|--|----------|
| 250EG35 | Reclining, Flip Back <i>(Height Adjustable 8" to 13")</i> | NC |
| 250EG36 | Reclining, Flip Back with 2-point post locking arm <i>(Height Adjustable 11" to 13" x .625")</i> | \$325.00 |
| 250EG32 | Single Post, Flip Back <i>(N/A with thigh support) (Height Adjustable 10" to 15")</i> | NC |
| 250EG33 | Single Post, Removable <i>(N/A with thigh support) (Height Adjustable 10" to 15")</i> | NC |
| 250EG34 | Single Post, SEDEO LITE, Removable <i>(N/A with thigh support), (Height Adjustable 10" to 15")</i> | NC |

Arm Pads P. 26

\$

SEDEO® Armrest Pad

| | | |
|---------|--|----|
| 250AB62 | 300 mm / 12", Integral Foam, Right | NC |
| 250AE62 | 300 mm / 12", Integral Foam, Left | NC |
| 250AB63 | 400 mm / 16", Integral Foam, Right | NC |
| 250AE63 | 400 mm / 16", Integral Foam, Left | NC |
| 250AB45 | Wide, 450 mm, Integral Foam, Right <i>(Increases armpad width by 1.5". May prevent flip-back.)</i> | NC |
| 250AE45 | Wide, 450 mm, Integral Foam, Left <i>(Increases armpad width by 1.5". May prevent flip-back.)</i> | NC |
| 250AB61 | SEDEO LITE Pad, Right | NC |
| 250AE61 | SEDEO LITE Pad, Left | NC |

POSITIONING SUPPORTS & ACCESSORIES (Seating Benefits)

| OPTION | DESCRIPTION | RETAIL |
|---|--|------------|
| Comfort Arm Pad (Foam) | | |
| 250AB46 | 2" Wide Right | \$104.00 |
| 250AE46 | 2" Wide Left | \$104.00 |
| 250AB47 | 4" Wide Right | \$104.00 |
| 250AE47 | 4" Wide Left | \$104.00 |
| Comfort Arm Pad (Gel) | | |
| 250AB48 | 2" Wide Right | \$197.00 |
| 250AE48 | 2" Wide Left | \$197.00 |
| 250AB49 | 4" Wide Right | \$197.00 |
| 250AE49 | 4" Wide Left | \$197.00 |
| AES Trough/Elbow Block Arm Pads (Gel) | | |
| 250AB50 | 3.5" x 13" Right | \$274.00 |
| 250AE50 | 3.5" x 13" Left | \$274.00 |
| 250AB51 | 4" x 14.5" Right | \$274.00 |
| 250AE51 | 4" x 14.5" Left | \$274.00 |
| Side Guards (Pair) (Client Cost) \$ | | |
| 250SG43 | Side Guards (9"L x 5.5"H) (N/A with Reclining Armrests) | \$228.00 |
| 250SG44 | Side Guards Integral Foam (11"L x 5.5"H) (N/A with Reclining Armrests) | \$328.00 |
| 250SG45 | Side Guards Wedge Shaped, Padded ((18"L x 5"H, 3" thick in front, 1.5" thick in rear) (Only with Single Post Removable Armrests) | \$328.00 |
| 250SG46 | Side Guards Mounted On Seat Rail Bracket (Only with Reclining Armrests) (N/A with Thigh Supports) | \$328.00 |
| Fixed Centermount Legrest \$ | | |
| 250H183 | SEDEO® Fixed Centermount Legrest (3" to 17.5" Leg Length) | \$316.00 |
| 250H184 | Fixed Centermount Legrest, Short (Includes Calf Pads & Single Footplate) (11.5" to 14.5" Leg Length) | NC |
| 250H185 | Fixed Centermount Legrest, Long (Includes Calf Pads & Single Footplate) (13.5" to 18.5" Leg Length) | NC |
| 250H186 | Angle Adjustable Centermount Legrest, Long (Only Available with Sedeo Lite) (11.5" to 18.5" Leg Length) | \$558.00 |
| Power Centermount Legrest (Client Cost)  P. 26 \$ | | |
| 250H175 | Power Centermount Legrest, 90° - 0° Angle, 7.5" Extension (Mechanical Articulation) (5" to 17.5" Leg Length) | \$2,295.00 |
| 250H109 | Power Centermount Legrest, 90° - 0° Angle, 7.5" Extension (Powered Articulation) (3" to 17.5" Leg Length) | \$3,169.00 |
| Power Centermount Legrest Accessories (Client Cost) \$ | | |
| Footplates | | |
| 250F127 | Dual, Height, Width and Angle Adjustable, Standard (14"W x 10"D) | \$262.00 |
| 250F128 | Dual, Height, Width and Angle Adjustable, Large (16"W x 12"D) | \$262.00 |
| Calf Pad Options | | |
| 250DI34 | Calf Pads, Pair, Standard | NC |
| 250DI35 | Extra Large Pair Calf Pads for Centermount Legrests, Fully adjustable (N/A w/ Std footplates) | \$328.00 |

POSITIONING SUPPORTS & ACCESSORIES

| OPTION | DESCRIPTION | RETAIL |
|---|---|------------|
| SEDEO® PRO™ Swing-Away Legrest (Pair) (250H179 is Client Cost) | | \$ |
| 250H177 | Legrests, Swing-Away, 70°, SEDEO® PRO™ (14" to 21" Leg Length) | NC |
| 250H178 | Legrests, Manual Elevating, Swing-Away, SEDEO® PRO™ (Includes Padded Calf Pads) (14".5 to 21.5" Leg Length) | \$558.00 |
| 250H179 | Legrests, Power Elevating, Swing-Away, SEDEO® PRO™ (Includes Padded Calf Pads) (15.5" to 22.5" Leg Length) | \$3,169.00 |
| 250H180 | Hanger Receivers Only, SEDEO® PRO™ | NC |
| 250DI76 | Omit Legrests | NC |
| Swing-Away Legrest Footplates | | |
| 250F360 | Footplate, For Seat Width 15" - 16" | \$262.00 |
| 250F361 | Footplate, For Seat Width 17" - 18" | \$262.00 |
| 250F362 | Footplate, For Seat Width 19" - 20" | \$262.00 |
| 250F363 | Footplate, For Seat Width 21" - 22" | \$262.00 |
| Swing-Away Legrest Calf Supports | | |
| 250DI41 | Calf Support, Depth Adjustable, Integral Foam (7" Wide x 10" Tall, NA 16-17" W) | \$384.00 |
| 250DI42 | Calf Support, Depth Adjustable, Padded (6.5" to 8" Wide, Depending On Chair Width, x 9.5" Tall) | \$472.00 |
| Swing-Away Legrest Options | | |
| 250F364 | Footplates, Coupled | \$262.00 |
| 250DI44 | Heel Loops | NC |
| 250DI40 | Calf Strap (Only For 70° Swing-Away Legrests) | \$130.00 |
| 250KG4 | Knee Pads, Integral Foam (2.5" Wide x 4.5" Tall) | \$260.00 |
| SEDEO® Lower Extremity Swing-Away Support | | |
| 250VD01 | Lower Extremity Support, Padded, Swing-Away, SEDEO®, Right | \$472.00 |
| 250VD02 | Lower Extremity Support, Padded, Swing-Away, SEDEO®, Left | \$472.00 |
| Pelvic Positioning Belts  P. 26 | | \$ |
| 250A837 | Positioning Belt, Auto Style Buckle, 50 mm 1600 mm / 2" | NC |
| 250A839 | Positioning Belt, Aircraft Buckle, 50 mm x 1300 mm / 2" | NC |
| 250A840 | Positioning Belt, Aircraft Buckle, Padded 50 mm x 1300 mm / 2" | \$95.00 |
| Accessories | | \$ |
| Ventilator Option | | |
| 250VT12 | Vent Tray Fixed (Pulmonetic LTV Models) | \$562.00 |
| O2 Tank Option | | |
| 250A718 | O2 Tank Holder Mounted to Backrest (D and E Styles) | \$361.00 |
| Wheelchair Tray Table | | |
| 2507A09 | Tray, Swing-Away | \$351.00 |
| Backpack (Client Cost) | | |
| 250A1 | Black Utility | \$103.00 |
| Misc. Accessories (Client Cost) | | |
| 2508A59 | Transfer Bar (Pair) | \$455.00 |
| 2508A52 | Ram Mount Phone | \$71.00 |
| 2508A53 | Ram Mount Tablet | \$284.00 |
| 2508A54 | Ram Mount Cup Holder | \$71.00 |
| 2508A58 | Rear View Mirror | \$71.00 |

| JOYSTICK / ELECTRONICS | | | |
|---|--|---|------------|
| OPTION | | DESCRIPTION | RETAIL |
| Seating Control <i>(Button Switches will not be mounted)</i> | | | \$ |
| Switch Controls Only | | | |
| 250E033 | | Dual Toggle for one Actuator | NC |
| 250E034 | | Buddy Button for 1 actuator | NC |
| 250E035 | | Switch-It Mini 1 button for 1 Actuator | NC |
| 250E036 | | Switch-It Mini 2 button for 1 Actuator | NC |
| Toggle Mount | | | |
| 250TN1 | | Toggle Mount, Right | NC |
| 250TN2 | | Toggle Mount, Left | NC |
| Thru-Drive Control | | | |
| 250E037 | | Thru-drive Control for 1 Actuator | \$1,332.00 |
| 250E038 | | Thru-drive Control for 2+ Actuators | \$2,679.00 |
| Attendant Controls (Prior Approval Required)  P. 27 | | | \$ |
| 2500A05 | | Dual Control Module for Attendant | \$1,131.00 |
| 2500A06 | | R-net Color LCD (CJSM1) Control Attendant Only | \$1,131.00 |
| Attendant Mounting Location  P. 27 | | | \$ |
| 250DN5 | | Right Back Cane | NC |
| 2500DN6 | | Left Back Cane | NC |
| R-net Joystick <i>(Remote)</i>  P. 27 | | | \$ |
| 250J121 | | Standard LED Joystick <i>(w/o Screen Display)</i> | NC |
| 250J116 | | Color Joystick <i>(2.3" Color LCD Screen Display, CJSM1)</i> | NC |
| 250J117 | | Heavy Duty Color Joystick <i>(2.3" Color LCD Screen Display, Fixed Joystick Mount Only)</i> | \$1,495.00 |
| 250J118 | | High Resolution Color Joystick,(CJSM2+BT) <i>3.5" Color LCD Display, Paddle Switches, Programmable Shortcut Keys, ICONs, Stereo Jack, IR and dual (IOS/Android) Bluetooth control</i> (Client Cost) | \$1,167.00 |
| 250J119 | | Omit Remote Control <i>(Required with arm mounted specialty controls)</i> | -\$25.00 |
| Joystick Mounting | | | \$ |
| 250JM34 | | Fixed on Armrest | NC |
| 250JM35 | | Parallel Swing-Away | \$412.00 |
| 250JM36 | | Link-It Mid Line Mount on Armrest <i>(Swing-Away)</i> | \$412.00 |
| Joystick Mount (Location) | | | \$ |
| 250HM16 | | Right Hand Armrest | NC |
| 250HM17 | | Left Hand Armrest | NC |
| Display Language Selection R-net | | | \$ |
| 250L1 | | English | NC |
| 250L3 | | French | NC |
| 250L7 | | Spanish | NC |

JOYSTICK / ELECTRONICS

| OPTION | DESCRIPTION | RETAIL |
|---|--|------------|
| Joystick Handle (Optional) <i>N/A with HD Joystick</i>  P. 27 \$ | | |
| 250JH13 | Ball Handle | \$101.00 |
| 250JH14 | Foam Ball Handle | \$101.00 |
| 250JH15 | T-Handle | \$101.00 |
| 250JH16 | Goalpost | \$101.00 |
| Table Top Controls \$ | | |
| 250OG09 | Table Top Control LCD Remote Control, Center Tray Mounted, Included | \$3,250.00 |
| Electronic Programmings  P. 27 \$ | | |
| 250PR10 | R-net PC Programmer w/ Dongle | \$652.00 |
| R-net Power Modules  P. 27 \$ | | |
| 250ER11 | Power Module, R-net, 120A, Non-Expandable <i>(Only available with High Performance)</i> | NC |
| 250ER10 | Power Module, R-net, 120A, Expandable <i>((Includes Expandable Controller & Harness) (Only Available with High Performance))</i> | NC |
| 250EX09 | Expandable 120A Controller - R-net | |
| 250EX10 | Harness for 120A Expandable Controller | |
| 250ER17 | Power Module, R-net, 90A, Expandable <i>(Includes Expandable Controller & Harness)</i> | NC |
| 250EX15 | Expandable 90A Controller - R-net | |
| 250EX16 | Harness for 90A Expandable Controller | |
| Ctrl+5® Switchbox Options \$ | | |
| 250QG11 | Ctrl+5 Switch Box With Free Assignable Functions | \$995.00 |
| 250QG12 | Ctrl+5 Switch Box With Free Assignable Functions <i>(Multi-power only)</i> | NC |
| Ctrl+5 Mounting location | | |
| 250EY19 | Right Armrest | NC |
| 250EY20 | Left Armrest | NC |
| 250EY21 | Back Cane, Right | NC |
| 250EY24 | Back Cane, Left | NC |
| Ctrl+5® Switch Type  P. 27 \$ | | |
| 250EY22 | Push Buttons | NC |
| 250EY23 | Toggle Switches | \$328.00 |
| R-net Optional Controls / Electronics  P. 28 <i>Not available if LED lights and SureTrac are both selected.</i> \$ | | |
| 250DA07 | Bluetooth Mouse Module, R-net | \$1,131.00 |
| 250DA08 | 2nd Bluetooth Mouse Module, R-net <i>(Android and Windows)</i> | \$1,131.00 |
| 250DA09 | IOS Bluetooth Mouse Module, R-net <i>(Apple)</i> | \$1,131.00 |
| R-net Programming Selection \$ | | |
| Assignable Buttons | | |
| <i>Assignable Button feature allows for modification of joystick buttons and/or Ctrl+5 Switches allowing access to various wheelchair and seating functions. When enabled, chair will be pre-programmed with seating functions assigned to buttons on the joystick. Assignments can be changed via PC Dongle.</i> | | |
| 250PM12 | Include Assignable Buttons | NC |
| 250PM13 | Omit Assignable Buttons | NC |

JOYSTICK / ELECTRONICS

| OPTION | DESCRIPTION | RETAIL |
|---|--|------------|
| R-net Programming Selection (cont'd) | | \$ |
| Power Centermount Footplate Extension Option (Client Cost) | | |
| 250IE03 | Include 7.5" Powered Footplate Extension for Transfer Assist <i>(Electronics programmed to allow footplates to be extended with or without legrest being raised.) Only Available with Powered Articulation</i> | \$546.00 |
| 250IE04 | Omit Footplate Extension for Transfers. | NC |
| R-net Omni2 Options  P. 27 For Expandable Controls, choose all that apply. (AADL W100 Grant) | | \$ |
| 2500N14 | R-net Omni2 Only Input Control Module and 3.5" LCD Display w/ Built-In Infrared and Bluetooth® Choose Mount Below | \$2,201.00 |
| 2500N15 | R-net Omni2 Bundled Input Control Module and 3.5" LCD Display w/ Built-In Infrared and Bluetooth® Bundled Omni2 Available w/ Switch-It Input Devices | NC |
| Omni2 Mount <i>If used w/ Standard Joystick, it must be mounted opposite side.</i> (AADL W100 Grant) | | \$ |
| 250DS14 | Link-It with Parallel Swing-Away Omni2 Mount w/Rear Mounted Interface, Right | \$644.00 |
| 250DS15 | Link-It with Parallel Swing-Away Omni2 Mount w/Rear Mounted Interface, Left | \$644.00 |

SPECIALTY INPUT DEVICES (AADL W100 Grant)

| OPTION | DESCRIPTION | RETAIL |
|--------|-------------|--------|
|--------|-------------|--------|

Hand Control Packages  P. 28 *Requires Standard Joystick Omit / Only one hand control device can be ordered.* \$

Proportional Input Devices

| | | |
|---------|-----------------------------|------------|
| 250EU14 | Switch-It MicroGuide | \$4,284.00 |
| 250EU15 | Switch-It MicroPilot | \$4,284.00 |
| 250EU16 | Switch-It TouchDrive 2 | \$4,999.00 |
| 250EU17 | Switch-It VersaGuide | \$2,360.00 |
| 250EU18 | Switch-It VersaGuide EZ | \$2,789.00 |
| 250EU19 | All Round Joystick Standard | \$2,360.00 |
| 250EU20 | All Round Joystick Light | \$2,789.00 |

Mounting Position (Required)

| | | |
|---------|--|------------|
| 250EM04 | Link-It to the Backrest <i>(Not Available w/ Omit Back Cushion Type)</i> | \$1,235.00 |
| 250EM05 | Link-It to the Fixed Joystick Mount | \$384.00 |
| 250EM06 | Link-It to the Parallel Swing-Away Joystick Mount | \$644.00 |
| 250EM07 | Link-It to the Midline Swing-Away | \$1,365.00 |
| 250EM08 | Omit Mount | NC |

Mounting Platforms (Optional) *Not available w/ Link-It to Backrest*

| | | |
|---------|--|----------|
| 250MG16 | SunDisk Hand Tray <i>(Only available w/ MicroSeries Joysticks)</i> | \$384.00 |
| 250MG15 | Bullet Hand Tray | \$384.00 |

Mounting Location (Required)

| | | |
|---------|-------|----|
| 250IM09 | Right | NC |
| 250IM10 | Left | NC |

Switch Options

| | | |
|---|--|---|
| – | See Switch Selections <i>(Maximum 2)</i> | – |
|---|--|---|

Head Control Packages  P. 28 *(Select headrest mount on next page)* **(AADL W100 Grant)** \$

Only one head control device can be ordered.

Proportional Input Devices

| | | |
|---------|---|------------|
| 250EU25 | Switch-It DualPro® Proportional Head Array - Facial Pads | \$6,513.00 |
| 250EU44 | Switch-It DualPro® Proportional Head Array - Facial Pads - Dedicated Mode Outer Left | \$6,513.00 |
| 250EU45 | Switch-It DualPro® Proportional Head Array - Facial Pads - Dedicated Mode Outer Right | \$6,513.00 |
| 250EU46 | Switch-It DualPro® Proportional Head Array - Facial Pads - Dedicated Mode & Reverse | \$6,513.00 |
| 250EU26 | Switch-It DualPro® Proportional Head Array - Spot Pads | \$6,513.00 |
| 250EU27 | Switch-It RIM Proportional Head Control | \$6,513.00 |
| 250EU20 | Switch-It RIM Proportional Head Control | \$6,513.00 |

Switched Input Devices

| | | |
|---------|---|------------|
| 250EU28 | Switch-It 3-Switch Head Array - Short Curved Wings | \$5,679.00 |
| 250EU29 | Switch-It 3-Switch Head Array - Short Straight Wings | \$5,679.00 |
| 250EU30 | Switch-It 3-Switch Head Array - Long Curved Wings | \$5,679.00 |
| 250EU31 | Switch-It 3-Switch Head Array - Long Straight Wings | \$5,679.00 |
| 250EU42 | Switch-It 4-Switch Head Array - Long Straight Wings Only - Mode Outer Left | \$5,679.00 |
| 250EU43 | Switch-It 4-Switch Head Array - Long Straight Wings Only - Mode Outer Right | \$5,679.00 |
| 250EU33 | Switch-It 5-Switch Head Array - Long Straight Wings Only - Mode Outer Left | \$5,679.00 |
| 250EU47 | Switch-It 5-Switch Head Array - Long Straight Wings Only - Mode Outer Right | \$5,679.00 |

SPECIALTY INPUT DEVICES (AADL W100 Grant)

| OPTION | DESCRIPTION | RETAIL |
|--------|-------------|--------|
|--------|-------------|--------|

Head Control Packages (cont'd) \$**Switch Options**

| | | |
|---|--|---|
| – | See Switch Selections (<i>Maximum 2</i>) | – |
|---|--|---|

Sip 'N Puff (AADL W100 Grant) \$

| | | |
|---------|---|------------|
| 250ID73 | Switch-It Sip 'N Puff Combo Head Array with Link-It Hardware (<i>Requires headrest mount</i>) | \$6,494.00 |
| 250ID74 | Switch-It OptiStop with Sip 'N Puff | \$2,529.00 |

Headrest Mounts (*Applies to Head/Sip 'N Puff control packages*) (AADL W100 Grant) \$

| | | |
|---------|---|----------|
| 250IJ13 | Whitmyer® Linx Headrest Mount with Quick Release | \$215.00 |
| 250IJ14 | Whitmyer® Linx-2 Headrest Mount with Quick Release | \$260.00 |
| 250IJ15 | Whitmyer® AXYS Headrest Mount with Quick Release | \$215.00 |
| 250IJ16 | Whitmyer® AXYS Offset Headrest Mount with Quick Release | \$215.00 |
| 250IJ17 | Whitmyer® Cobra FB Headrest Mount with Quick Release | \$515.00 |

Chin Control Packages (AADL W100 Grant)  P. 28 \$**Proportional Input Devices**

| | | |
|---------|---|------------|
| 250EU34 | Switch-It MicroGuide (<i>Switches mounted to the headrest only.</i>) | \$4,284.00 |
| 250EU35 | Switch-It MicroPilot (<i>Switches mounted to the headrest only.</i>) | \$4,284.00 |
| 250EU36 | Switch-It VersaGuide | \$2,360.00 |
| 250EU37 | Switch-It VersaGuide EZ | \$2,789.00 |
| 250EU38 | All Round Joystick Light - Omni2 (<i>Requires satellite twister switches.</i>) | \$2,360.00 |
| 250EU39 | All Round Joystick Standard - Omni2 (<i>Requires satellite twister switches.</i>) | \$2,789.00 |

Mounting Position

| | | |
|---------|---|------------|
| 250EM09 | Link-It To Chin Harness, Small (150mm / 6") | \$1,625.00 |
| 250EM10 | Link-It To Chin Harness, Large (220mm / 8") | \$1,625.00 |
| 250EM11 | Link-It To Headrest, Swing-Away | \$1,625.00 |
| 250EM53 | Link-It To Manual Chin Boom - Right Side | \$4,934.00 |
| 250EM54 | Link-It To Manual Chin Boom - Left Side | \$4,934.00 |
| 250EM55 | Link-It To Power Chin Boom - Right Side | \$8,444.00 |
| 250EM56 | Link-It To Power Chin Boom - Left Side | \$8,444.00 |
| 250EM16 | Omit Mount | NC |

Input Device Mounting Location

| | | |
|---------|-------|----|
| 250IM13 | Right | NC |
| 250IM14 | Left | NC |

Switch Options

| | | |
|---|---|---|
| – | See Switch Selections (<i>Minimum 1 for the Power Chin Boom, Maximum 3</i>) | – |
|---|---|---|

Safety Devices (AADL W100 Grant) \$

| | | |
|---------|--|------------|
| 250SA06 | Switch-It Remote Stop Switch - XLR Connector | \$1,216.00 |
|---------|--|------------|

Switched Driving Packages (AADL W100 Grant) \$

| | | |
|---------|---|------------|
| 250SW43 | SJX6 Hub - 6 Powered SmartJacks for Driving, Mode and User Switch - Select Maximum 6 Switches | \$2,334.00 |
|---------|---|------------|

SPECIALTY INPUT DEVICES

| OPTION | DESCRIPTION | RETAIL |
|--------|-------------|--------|
|--------|-------------|--------|

Switches  P. 29

Single switches can be programmed to activate any function of the wheelchair including: On/Off, Mode, Profile, Speeds, Seating, Memory Positions, Horn, Lights & Indicators, IR functions, Bluetooth mouse clicks, Environmental Controls when plugged into assignable port.

Switches can connect via: Joysticks (Standard, Micro series, Versa series, All-round series) Omni2, SJX6 Hub, head controls

Switch ordering instructions:

1. Select switch type and quantity in Section "A" using columns below. (Max 6 switches. See limitations below.)
2. Select switch mounting position from Section "B" using corresponding switch column.
3. Select switch mounting location from Section "C" using corresponding switch column.

Section A – Switch Selections**Switch / Quantity**

| Single Function Switches - Mechanical Switches | Switch 1 | Switch 2 | Switch 3 | Switch 4 | Switch 5 | Switch 6 | \$ |
|--|----------|----------|----------|----------|----------|----------|----------|
| Buddy Button - Black | | | | | | | \$101.00 |
| Buddy Button - Blue | | | | | | | \$101.00 |
| Buddy Button - Green | | | | | | | \$101.00 |
| Buddy Button - Red | | | | | | | \$101.00 |
| Buddy Button - Yellow | | | | | | | \$101.00 |
| Egg Switch - Black | | | | | | | \$101.00 |
| Egg Switch - Blue | | | | | | | \$101.00 |
| Egg Switch - Green | | | | | | | \$101.00 |
| Egg Switch - Red | | | | | | | \$101.00 |
| Egg Switch - Yellow | | | | | | | \$101.00 |
| MicroLite (Includes color labels) | | | | | | | \$106.00 |
| Mini Button 1 - Blue (Velcro) | | | | | | | \$284.00 |
| Mini Button 1 - Green (Velcro) | | | | | | | \$284.00 |
| Mini Button 1 - Red (Velcro) | | | | | | | \$284.00 |
| Piko - Black | | | | | | | \$358.00 |
| Piko - Blue | | | | | | | \$358.00 |
| Piko - Green | | | | | | | \$358.00 |
| Piko - Orange | | | | | | | \$358.00 |
| Piko - Red | | | | | | | \$358.00 |
| Piko - Yellow | | | | | | | \$358.00 |
| Twister Switch - Black (Must choose mount and location) | | | | | | | \$228.00 |
| Twister Switch - Green (Must choose mount and location) | | | | | | | \$228.00 |
| Twister Switch - Red (Must choose mount and location) | | | | | | | \$228.00 |
| Electronic Switches | | | | | | | |
| Flex Switch (Headrest mount only) | | | | | | | \$280.00 |
| Zero Touch Proximity Sensor | | | | | | | \$254.00 |
| Section B – Switch Mounting Position | | | | | | | |
| Link-It to the Backrest (Up to 1 per side) | | | | | | | \$845.00 |
| Link-It to the Headrest - Gooseneck & Rigid (Up to 2 per side) | | | | | | | \$845.00 |
| Link-It to the Fixed Joystick Mount (Up to 2 per side) | | | | | | | \$644.00 |
| Link-It to the Parallel Swing-Away Joystick Mount (Up to 2 per side) | | | | | | | \$644.00 |
| Link-It to the Seat Rail (Up to 2 per side) (Not avail w/knee & thigh supports) | | | | | | | \$514.00 |
| Omit Mount (includes Velcro) | | | | | | | NC |
| Section C – Switch Mounting Location | | | | | | | |
| Right side of chair | | | | | | | NC |
| Left side of chair | | | | | | | NC |

JAY® SYNCRA™ SEATING MEASURING GUIDE

JAY® SYNCRA™ BACK



| | | | | |
|-----------------------------|-------|-------|-------|-------|
| Backrest Width | 16" | 18" | 20" | 22" |
| Max User Trunk Width | 13.5" | 15.5" | 17.5" | 19.5" |

JAY® Swing-Away Lateral Thoracic Adjustment Range

| Syncra Back Width | Width Range | Height range from bottom of shell to seat pan |
|-------------------|-------------|---|
| 16" | 10" to 24" | 12" to 19.5" |
| 18" | 12" to 26" | 12.5" to 21.5" |
| 20" | 14" to 28" | 12.5" to 22" |
| 22" | 16" to 30" | 13.5" to 23" |

Syncra™ Fixed Lateral Support Accessory Range

| Syncra Back Width | Width Range | Height range from bottom of shell to seat pan | Contour Depth Range |
|-------------------|----------------|---|---------------------|
| 16" | 16.4" to 16.8" | 6" to 8" | 3" to 5" |
| 18" | 18.4" to 18.8" | 6" to 8" | 3" to 5" |
| 20" | 20.4" to 20.8" | 6" to 8" | 3" to 5" |
| 22" | 22.4" to 22.8" | 6" to 8" | 3" to 5" |

Syncra™ Back Shell Height Diagram

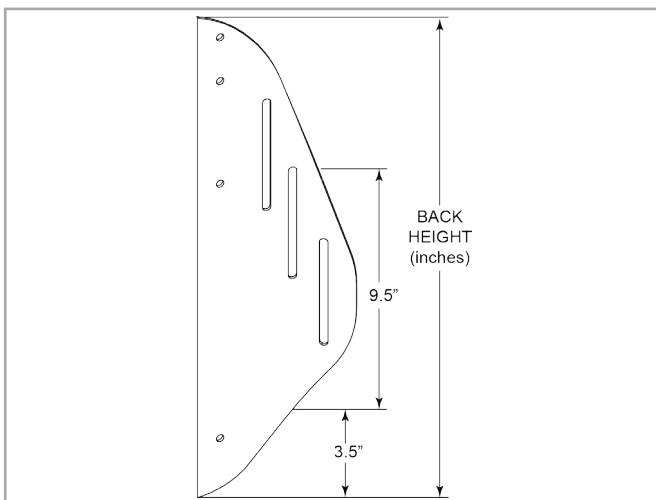

JAY® SYNCRA™ CUSHION



JAY® Lateral Thigh Support Adjustment Range

| Syncra Cushion Width | Width Range |
|----------------------|----------------|
| 16" | 8.5" to 16.0" |
| 17" | 9.5" to 17.0" |
| 18" | 10.5" to 18.0" |
| 19" | 11.5" to 19.0" |
| 20" | 12.5" to 20.0" |
| 22" | 14.5" to 22.0" |

POWER BASE

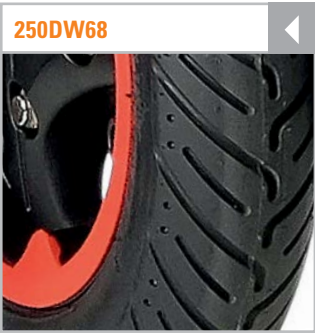

250DW68

14" Drive Wheel, Pneumatic, V-Type

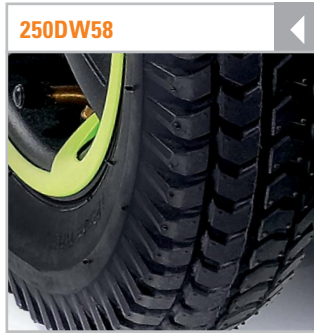

250DW58

14" Drive Wheel, Knobby



250CW55

6" Caster Wheels

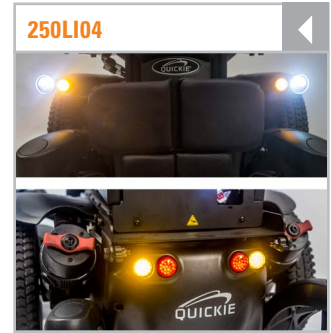

250LI04

LED Lights



250BJ28

Charger

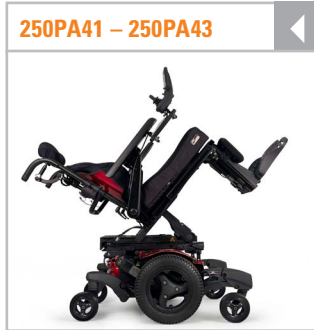

250PA41 – 250PA43

Power Seating: Tilt, Recline

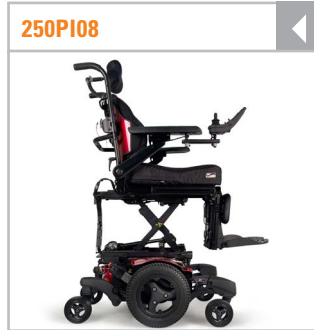

250PI08

Power Seating: Elevate

SEATING AND POSITIONING



250JP01

JAY® J3® Back: 2.2"



250JP11

JAY® J3® Back: 3"



250JP13

JAY® J3® Back: 6"

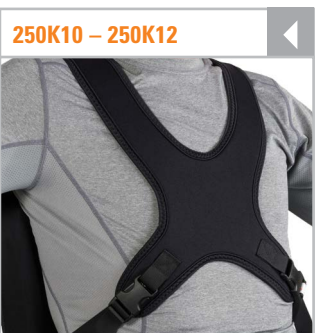

250K10 – 250K12

JAY® Anterior Thoracic Support



250JS02 – 250JS04

JAY® J3® Back, Spine-Align Kit 2

SEATING AND POSITIONING

250CU59



JAY® Ion® Cushion

250CU61



JAY® Union® Cushion

250CU66



JAY® Fusion® Cushion w/Air

250CU64



JAY® Fusion® Cushion w/Fluid

250CU55



JAY® X2® Cushion

250CU56



JAY® J2® Cushion

250CU57



JAY® J2® Deep Contour Cushion

250EG35



SEDEO® Reclining Flip Back Armrest

250AB47



Comfort Reclining Armpad, Foam

250AB43



SEDEO® Reclining Armrest Pad

250AB48



Comfort Reclining Armpad, Gel

250H109



Power Centermount Legrest,
Power Articulation

250H175



Power Centermount Legrest,
Mechanical Articulation

SEATING AND POSITIONING



Positioning Belt, Aircraft Style



SEDEO® Headrest, Small



SEDEO® Headrest, Flexible

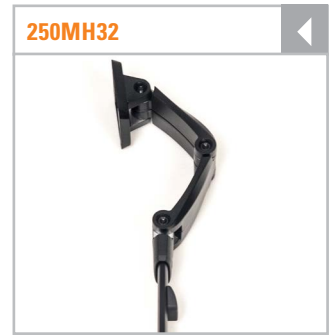

SEDEO® Multiposition Headrest Mount



Whitmyer® Plush Headrest



Whitmyer® Adjust-a-Plush Headrest

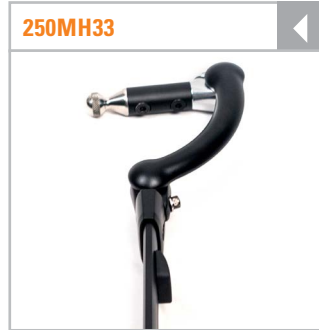

Whitmyer® Linx Headrest Mount

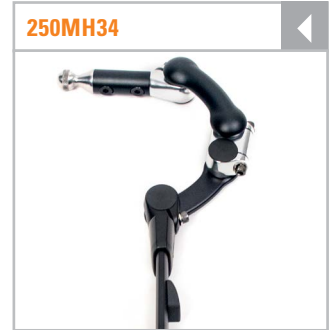

Whitmyer® Linx-2 Headrest Mount

ELECTRONICS



Color Joystick



Heavy Duty Color Joystick

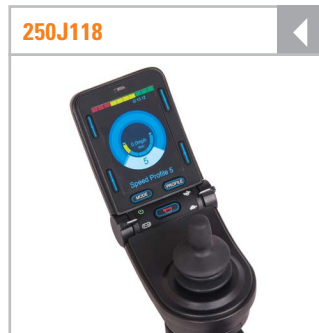

High Resolution Color Joystick, (CJSM2+BT)



Goalpost Joystick Handle



T-Handle Joystick Handle

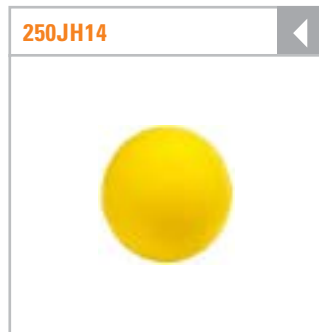

Foam Ball Joystick Handle



Ball Joystick Handle

ELECTRONICS

250PR10



R-net PC Programmer

250ER10



R-net Power Module

250EY22



Ctrl+5®, Push Button

250EY23



Ctrl+5®, Toggle

250E034



2.5" Single Switch
black, blue, green, red, yellow

250E036



Mini 2 Button

250E035



Mini 1 Button (Mono Plug)
blue, green, red

ELECTRONICS

250EU14 & 250EU34



Switch-It™ MicroGuide

250EU15 & 250EU35



Switch-It™ MicroPilot

250EU16



Switch-It™ TouchDrive 2 (TD2)

250EU17 & 250EU36



Switch-It™ VersaGuide

250EM04



Link-It to Backrest

250EM05

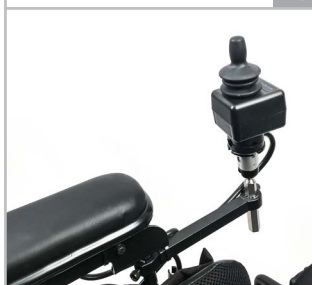

Link-It to Fixed Joystick Mount

250EM06



Link-It to Parallel Swing-Away Joystick Mount

zEM07

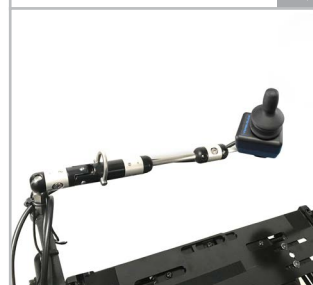

Link-It to Midline Swing-Away Joystick Mount

250EM09

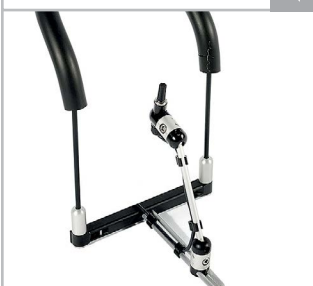

Link-It to Chin Harness

250EM11



Link-It to Headrest, Swing-Away

250EM53



Link-It to Manual Chin Boom

ELECTRONICS

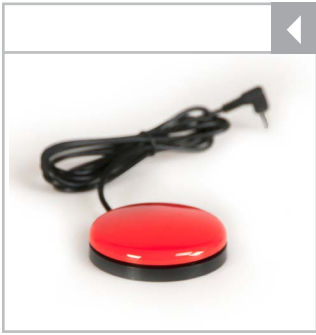

2.5" Single Switch
black, blue, green, red, yellow

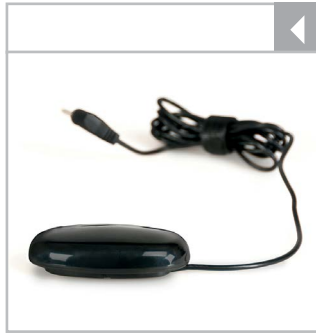

Egg Switch
black, blue, green, red, yellow



MicroLite



1" Single Switch
black, blue, green, orange, red, yellow

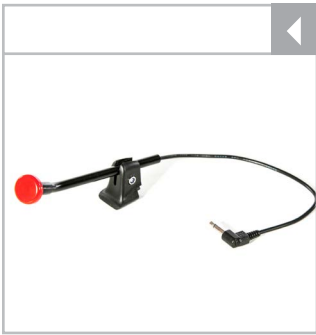

Twister Switch
black, green, red

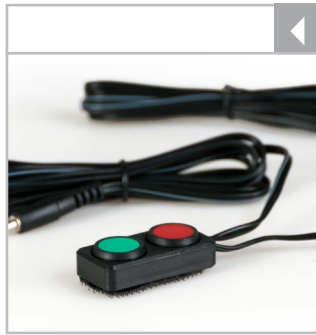

Mini 2

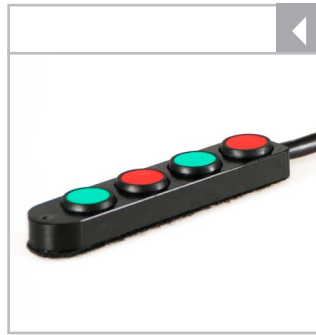

Mini 4



Mini 1 Button (Mono Plug)
blue, green, red



| Q700 M with SEDEO® LITE™ | | \$ |
|-------------------------------|--|----|
| Base Price | | |
| Total of additional equipment | | |
| Packaging and transport | | |
| Total Price | | |

| Date | | | Signature |
|-------|-----|------|-----------|
| Month | Day | Year | |



Customer Service: (800) 263-3390
 Fax: (800) 561-5834
 E-mail: cscanada@sunmed.com
www.sunrisemedical.ca
 Specifications are subject to change without notice.

© 2023 Sunrise Medical Canada Inc.
 237 Romina Drive, Unit 3
 Concord, Ontario
 L4K 4V3
 MK-129632-AADL, Rev. 6