



Customer Contact Details

Customer Name: _____

Advisor: _____

Address: _____

Phone: _____

Email: _____

Shipping Name: _____

Shipping Address: _____

Phone: _____

Email: _____

Additional Information

Notes: _____

Current Wheelchair: _____

Customer Weight: _____

Customer Height: _____

Customer Disability: _____

Guide:

- Base product
- Required option
- Optional Extra
- Critical Information
- Information Needed

PRODUCT STYLE

SBCXZ011 VEYPR SUB4
\$21,662.00

XA070 Open design

Max User Weight 110kg (242lbs)

Yes, I am within the max user weight

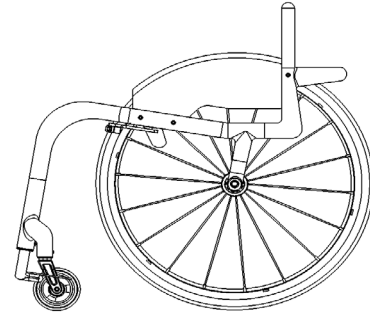

CAD APPROVAL

XW012 QUOTE CAD drawing for approval
\$550 FLAT FEE (includes two free revisions)

XW010 ORDER CAD drawing for approval
\$300 FLAT FEE (includes two free revisions)

XW009 QUOTE only no CAD \$0

XW011 ORDER only no CAD \$0

KEY MEASUREMENTS

XY010 Seat width (Inside of sideguards)

(Max - 440mm)
(Min - 250mm)

XY020 Seat length

(Max - 440mm)
(Min - 250mm)

XY030 Extra seat length (Provides additional leg support & hand grip)

(Max - 460mm total seat)

XY050 Front frame height

(Max - 520mm)
(Min - 380mm)

XY060 Rear frame height

(Max - 500mm)
(Min - 380mm)

XY070 Frame length

(Min = XY020 + XY030 + 140mm)
(Max - 625mm)

XY072 Caster position

Optimize measurements

XA020 Ergonomic seat
\$119.00

Specify length

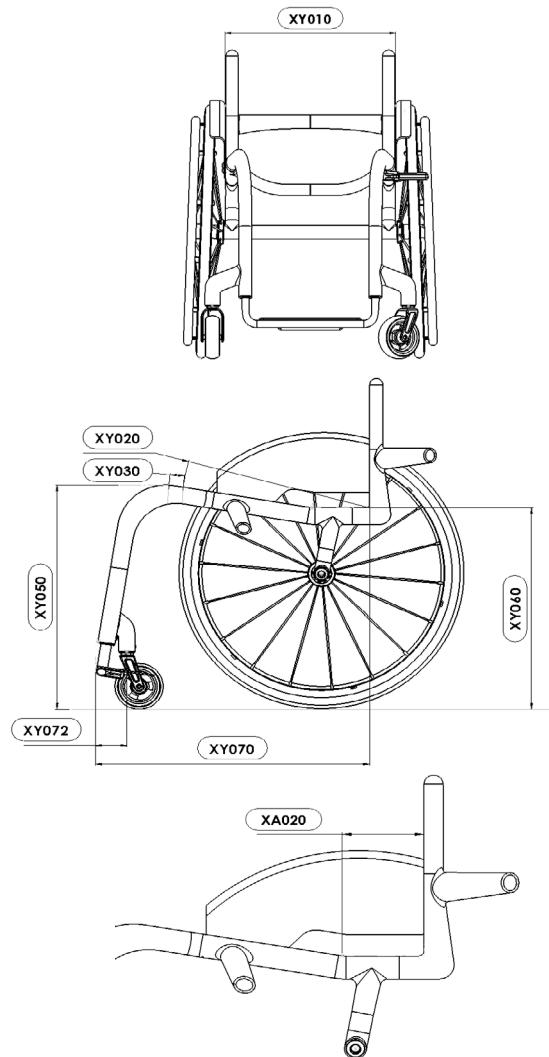

FRONT FRAME AND FOOTREST

Front Frame Options

XY080 Seat taper design

i Specify width mm

(When combined with XY091, dimension is inbetween the centre of the main bends)

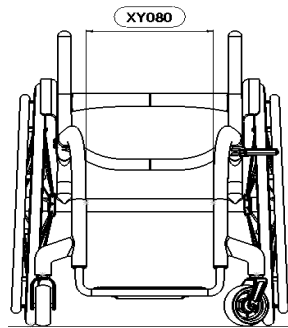

XY091 Parallel taper design

i Specify width mm

(When combined with XY080 dimensions must be smaller 20mm)

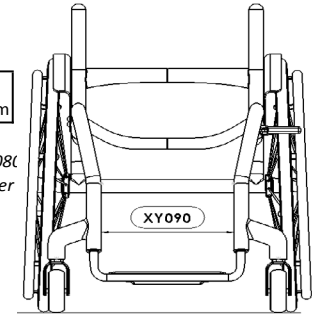

Footrest Design (Choose one)

XY100 Round design

Caster Wheel Size	Max Height Achievable
4"	150

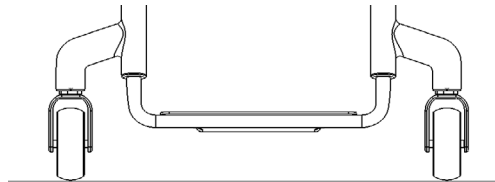

Footrest Measurements

XY115 Front footrest height

! mm

XY120 Rear footrest height

i mm

Std = 20 lower than front height

XY125 Footrest length

i mm

Maximum length 120mm (Certified weight)

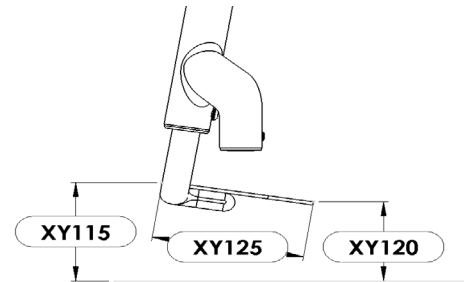

Footrest Style

SBCXB400 Carbon Fibre Footrest with Carbon Plate
(Height adjustable +/-12mm)

CASTER WHEELS, FORKS & WHEEL LOCKS

Caster Wheels

- XC135 Aluminium centre 4"x1.25"
Choose colour below:



- | | |
|--|---|
| <input type="checkbox"/> Silver hub & black tire (Std) | <input type="checkbox"/> Green hub & black tire |
| <input type="checkbox"/> Black hub & black tire | <input type="checkbox"/> Red hub & black tire |
| <input type="checkbox"/> Purple hub & black tire | <input type="checkbox"/> Blue hub & black tire |

Caster Forks

- XC192 Anti-Flutter Caster Fork

- | | | |
|--------------------------------|---------------------------------|---------------------------------|
| <input type="checkbox"/> Black | <input type="checkbox"/> Red | <input type="checkbox"/> Silver |
| <input type="checkbox"/> Blue | <input type="checkbox"/> Purple | |

Caster Pin Width

- XY330 Caster pin width
- Optimize measurements
(Minimum width for clear caster rotation and maximum wheelbase length)

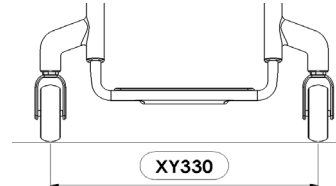

Wheel Lock Options

- SBCXD036 Compact scissor with lightweight fixing
- XD010 Omit wheel locks

SIDEGUARDS

Sideguard without Fender

- XE055 Screw on lightweight carbon fibre

Sideguard Measurements

- Individual above tire (Follow tire - max. 25mm)



mm

- Level with tire (Follow tire)

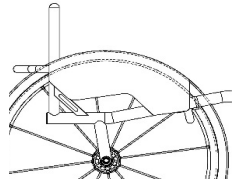

Sideguard with Fender

- XE065 Screw on lightweight carbon fibre w/fender

Sideguard Measurements

- 10mm above tire (Standard)

- Individual above tire (Min = 10mm)



mm

- Centre of tire

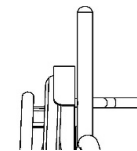
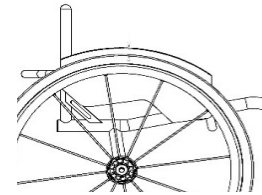

BACKREST

Backrest Height - Fixed



XY230

Backrest height

Specify height (400mm max)

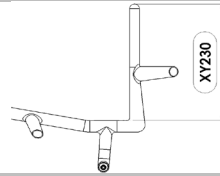
 mm

XG010

Fixed Backrest (non-folding)

Ergonomic Options



XY360

Backrest angle

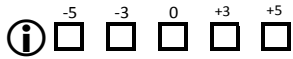

Individual

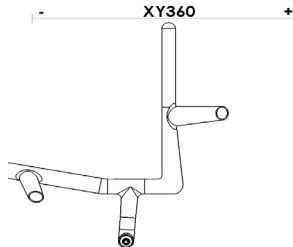
 Deg
(Max -10/+20 Deg)

XG100

Ergonomic backrest

\$144.00

Vertical height

 mm

Rearward position

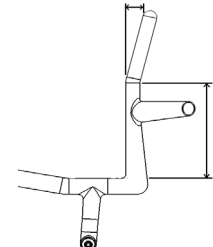

 mm

XG110

Inward taper
(inside of backrest posts)

\$144.00

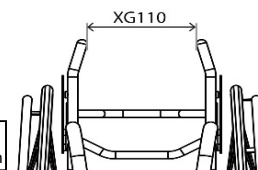
Specify width or per side



 mm

XG120

Outward flare
(inside of backrest posts)

\$144.00

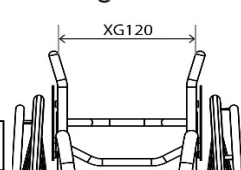
Specify width or per side

 mm

CAMBER BAR

Camber Angle



XY390

Camber angle

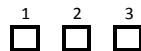

Centre of Gravity



SBCXH100

Single post fixed centre of gravity
(25-125mm)

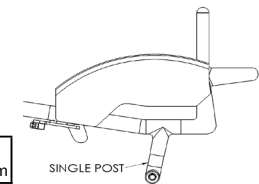

Specify length

 mm

FRAME FINISH OPTIONS

Frame and Footrest



SBCXN300

Carbon Fibre Matte finish



SBCXN305

Carbon Fibre Gloss finish

Accent Colour (Choose One)

Note: Accent colour includes decals only

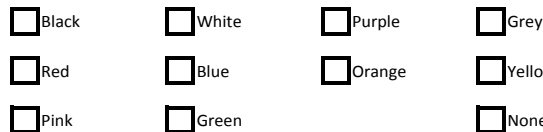

SBCXN250

Individual Accent Colour

\$186.00

UPHOLSTERY

Seat Upholstery



XP045

Sub4 Seat sling strap adjustable

Backrest Upholstery



XP035

Airtech Sub4 backrest strap adjustable



XP050

Airtech backrest strap adjustable ***Non Sub4 option**

Backrest Upholstery Stitching Options



Backrest Upholstery Logo Colour

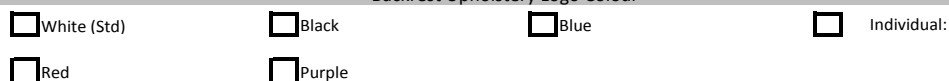

REAR WHEELS (* non certified weight options)

Rear Wheel Size

- XY420 24" Wheels
 XY430 25" Wheels

Rear Wheel Gap

XY460 Rear wheel gap

15
 20
 25

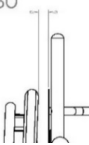

Rear Wheel Options

- XK075 Spinergy **BLXL** 18 blade spoke
(N/A with silver hub)
 SBCXK150 Spinergy **CLX** 18 carbon blade spoke
- XK226 Titanium 100mm quick release axle pins
 \$1,296.00 *(N/A with silver hub or colour rims)*

Spinergy Colour Options:

- | | | | |
|--|--|--|--|
| <input type="checkbox"/> Black spokes | <input type="checkbox"/> White spokes | <input type="checkbox"/> Yellow spokes | <input type="checkbox"/> XK180 Individual spoke design
<i>(Specify colour)</i>
Inside: _____
Outside: _____ |
| <input type="checkbox"/> Red spokes | <input type="checkbox"/> Blue spokes | <input type="checkbox"/> Pink spokes | |
| <input type="checkbox"/> Purple spokes | <input type="checkbox"/> Orange spokes | <input type="checkbox"/> Green spokes | |

Spinergy Anodize Options

- | | | | |
|---|---|---|---|
| <input type="checkbox"/> XK190 Black hub
NC <i>(std option)</i> | <input type="checkbox"/> XK201 Red hub/rims
\$403.00 <i>(LX, XLX & BLXL only)</i> | <input type="checkbox"/> XK204 Gold hub/rims
\$531.00 <i>(LX, XLX & BLXL only)</i> | <input type="checkbox"/> XK205 Individual hub/rims
\$560.00 Select colour: _____ |
| <input type="checkbox"/> XK202 Purple hub/rims
\$403.00 <i>(LX, XLX & BLXL only)</i> | <input type="checkbox"/> XK203 Blue hub/rims
\$403.00 <i>(LX, XLX & BLXL only)</i> | | |

Supply Without Wheels

- SBCXK040 Supply without Wheels

Wheel Type:
Tire Type:

Handrim Position / Options

- XY480 Narrow set handrim
 XY485 Wide set handrim
- XL090 Remove excess mounting tabs
\$144.00 *(recommended for small wheel gaps)*

Handrim Styles

- | | |
|--|--|
| <input type="checkbox"/> XL010 Aluminium hard anodized 6 tab | |
| <input type="checkbox"/> XL160 Elipse 6 tab
\$622.00 <i>(replacement for Surge)</i> | <input type="checkbox"/> XL040 Titanium 6 tab
\$439.00 |
| <input type="checkbox"/> XL020 Tetra grip 6 tab
\$394.00 | <input type="checkbox"/> XL050 Stainless steel 6 tab
\$244.00 |
| <input type="checkbox"/> XL100 Para grip 6 tab
\$394.00 | <input type="checkbox"/> RGK-XL140 Ergo gripp 6 tab wide
\$681.00 |

Tire Options

- XM060 Schwalbe One (Lightest option)
\$131.00
- XM010 Kenda

 Grey
 Blue
 Red
- XM020 Schwalbe Marathon Plus
\$97.00
 XM130 Kenda black
\$27.00
- XM040 Shox solid airless
\$158.00
 XM050 Kenda K885 mountain bike tire (24",25" only)
\$39.00

Inner Tube Valve Options

- XY500 Schraeder inner tube valve
(Standard if no option selected)

 XY490 Presta inner tube valve

* Indicates items that are not part of the certified weight of the Tiga Sub4

CUSHION (** non certified weight options)

Cushion foam options

- XP080 Cushion foam
\$119.00
(select density and size below)
- | | | |
|--|--|---|
| <input type="checkbox"/> Soft (CMS040) | <input type="checkbox"/> Medium (CMS050) | <input type="checkbox"/> Hard (9lb recon) |
| <input type="checkbox"/> 50mm | <input type="checkbox"/> 75mm | <input type="checkbox"/> 100mm |

Cushion cover upgrades

- XP085 Nylon cushion cover
(Black)
- XP090 Airlite cushion cover
\$97.00
(Black)
- XP100 Leather cushion cover
\$250.00
(Black)

Jay Products

- JAY Cushion
(Price dependant on size / option)
- JAY Backrest
(Price dependant on size / option)
- Refer to Jay Order Form*

ACCESSORIES (** non certified weight options)

- XP120 Frame protectors Neoprene zip fasten (Black)
\$83.00
- XP420 Frame protectors Nylon velcro fasten (Black)
\$80.00
- XR010 Seat pouch velcro attach (Black)
\$58.00
- XR200 Rucksack with RGK logo (Black)
\$149.00
- XR020 Underseat large storage bag (Black)
\$125.00
- XR090 Tool kit
- XS065 Sub4 Calf Strap

** indicates options that, when chosen, will not enable RGK to guarantee a Sub4kg product weight



OTHER (non certified weight options)**

Caster Wheel Size

XC140 Aluminium centre 5"x1.4"
\$229.00 *(Silver hub and black tire)*

XC145 Aluminium centre 6"x1.4"
\$305.00 *(Silver hub and black tire)*

Sideguards

XE030 Screw on aluminium, indicate size on page 4
\$322.00

Push handle Options

XG080 Flip down push handles
\$434.00

Anti-Tip Options

XJ100 Single sport anti tip
\$497.00

Seat Plate

XR050 Carbon fibre seat plate
\$473.00

Backrest Upholstery Leather Options (only with XP050)

XP070 Backrest upgrade to leather corners (Black)
\$119.00 *(only with Airtech upholstery XP050)*

Backrest Accessories (only with XP050)

XP110 Backrest with zip pocket
\$125.00

XP170 Individual backrest embroidery
\$236.00 *(Please provide .jpeg file and positioning)*

** indicates options that, when chosen, will not enable RGK to guarantee a Sub4kg product weight

ADDITIONAL NOTES

Large grid area for additional notes.