

**Customer Contact Details**

Customer Name: _____

Advisor: _____

Address: _____

Phone: _____

Email: _____

Ship to Customer Address:

Shipping Name: _____

Shipping Address: _____

Phone: _____

Email: _____

Additional InformationNotes: _____

Current Wheelchair: _____

Customer Weight: _____

Customer Height: _____

Customer Disability: _____

Guide:

- Base product
- Required option
- Optional Extra
- Critical Information
- Information Needed

PRODUCT STYLE

GSAXZ010 GRAND SLAM
\$7,520.00

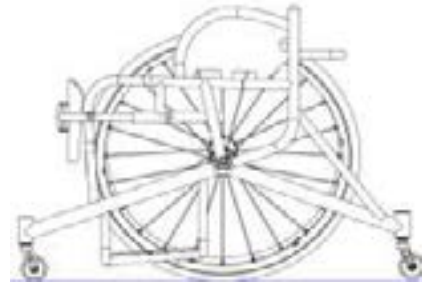

Max User Weight 125kg (275lbs)

Yes, I am within the max user weight

CAD APPROVAL

- XW012 QUOTE CAD drawing for approval
\$550 FLAT FEE (includes two free revisions)
- XW009 QUOTE only no CAD \$0

- XW010 ORDER CAD drawing for approval
\$300 FLAT FEE (includes two free revisions)
- XW011 ORDER only no CAD \$0

KEY MEASUREMENTS

- XY010 Seat width *(Inside to inside of sideguards)*
 mm *(Max - 500mm)*
- XY020 Seat length
 mm *(Max - 500mm)*
- XY030 Extra seat length *(Provides additional leg support & hand grip)*
 mm
- XY050 Front frame height
 mm *(Max - 630mm)
(Min - 360mm)*
- XY060 Rear frame height
 mm *(Max - 630mm)
(Min - 360mm)*
- XY070 Frame length
 mm *(Min XY020 + XY030 + 110mm)*
- XA020 Ergonomic seat
 \$119.00
 Specify length mm *(Standard = 120mm)*

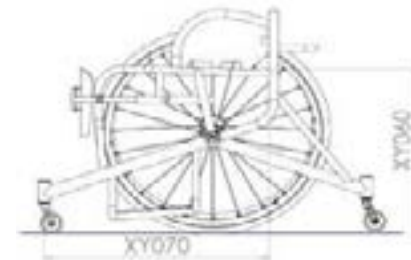
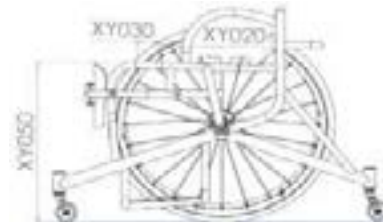
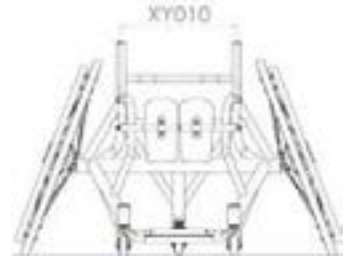

FRAME OPTIONS

Front Frame Options (Choose One)

XY080 Seat taper design

i Specify taper width
 mm



XA130 V-seat design
\$302.00

i Specify taper width
 mm



XA136 Frame front seat parallel design
\$89.00

i Specify width
 mm

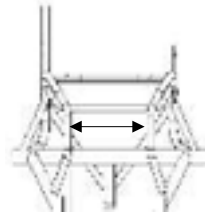

XA131 V-seat and Seat Taper Design
\$326.00

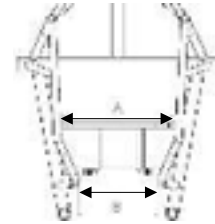

Knee Support Options

XA200 Knee support ratchet system
(Tubes on the **outside**)

i Specify length
 mm

Optimize (Smallest)

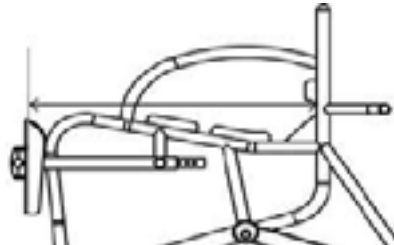

XA202 Plastic shin pads
(Includes 5mm hard padding)

XA203 Carbon fibre shin pads
\$729.00 (Includes 7mm hard padding)

XA204 Extra padding + cover for shin pads
\$178.00

i mm

Specify padding density

Med Hard

Seat Options

XR040 Aluminum seat plate
\$190.00 (riveted to frame)

i Specify length of plate
 mm (Std XY020 - 20mm)

XR050 Carbon fibre seat plate
\$473.00 (riveted to frame)



i Specify length of plate
 mm (Std XY020 - 20mm)

FOOTREST

Fixed Footrest

- GSAXB080 Fixed position footrest

Height and Position

- Front footrest height
 mm (min = 35mm) 
- Rear footrest height
 mm (min = 35mm) 
- Footrest position
 (front of footplate to castor pot)
 mm 

Footrest Size

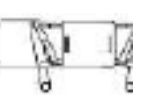
- Footrest width
 mm (Std = 200mm) 
- Footrest length
 mm (Std = 250mm) 



Footrest Plate

- XB180 Aluminium footplate
 (2.5mm)
- XB190 Carbon fibre footplate
 \$552.00
- XB100 ABS moulded foot tray
 \$180.00
 Specify length
 mm (Max = 380mm (Full)
 Std = 330mm) 
- GSAXB140 Spacer kit
 \$125.00 (Allows for 25mm increase in height)



Adjustable Footrest

- GSAXB130 Adjustable position footrest
 \$302.00

Height and Position

- Front footrest height
 mm (min = 40mm) 
- Rear footrest height
 mm (min = 40mm) 
- Footrest position
 (front of footplate to castor pot)
 mm 

Footrest Size (Not ABS)

- Footrest width
 mm (Std = 200mm) 
- Footrest length
 mm (Std = 250mm) 

Footrest Plate

- XB180 Aluminium footplate
 (5mm)
- XB100 ABS moulded foot tray
 Specify length
 mm (Max = 380mm (Full)
 Std = 330mm) 

Footrest Plate Options

- XB240 Aluminium raised edges (Cost per Edge)
 \$185.00
- Front Back Left Right
- Specify height
 (Max = 60mm)

Caster pin

- XY330 Caster pin width
 mm
- Optimize measurements

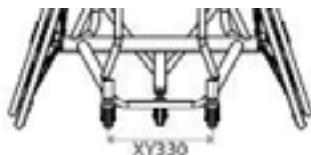

CAMBER BAR & ANTI-TIP

Centre of Gravity

 GSAXY510 Fixed centre of gravity

Specify measurement
 mm

(Note: dimension is taken from front of backrest post to centre of axle)

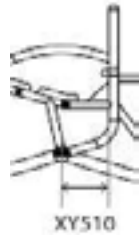
 GSAXY515 Backrest COG adjustment
 \$390.00
 (Not with welded sides)
 (+/-20mm)

Specify measurement
 mm

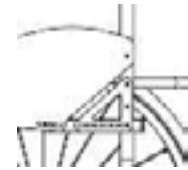
 GSAXY560 Adjustable centre of gravity

Specify measurement
 mm

Camber Angle & Anti Tip

 XY390 Camber angle

16 18 20 22

 GSAXJ040 Single fixed anti tip

Specify distance behind rear wheel
 mm (Std = 100mm)



SIDEGUARDS

Sideguard Style

 GSAXE240 Welded aluminium sport
 \$1,036.00

 XE030 Screw on aluminium
 \$322.00

 XE050 Screw on carbon fibre
 \$715.00

Sideguard Measurements

 Sideguard length

mm

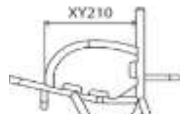

 25mm above tire
 (Follow tire)

 Individual above tire
 (Follow tire)

mm

 Sideguard height

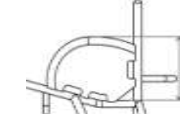
mm



 Level with tire
 (Follow tire)

BACKREST

Backrest Height (Choose One)

 XY230 Fixed backrest height

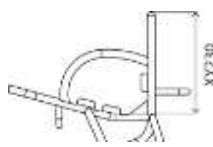
Specify height
 mm

 XY245 Adjustable backrest height
 \$244.00
 (+/-25mm)

Specify height
 mm



Ergonomic Options

 XY360 Backrest angle

-5 -3 0 +3 +5

Individual Deg
 (Max -10/+10 Deg)

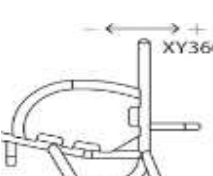
 XG100 Ergonomic backrest
 \$144.00

Vertical height
 mm



Rearward position
 mm

 XG110 Inward taper
 \$144.00
 (inside of backrest posts)

Specify width or per side
 mm

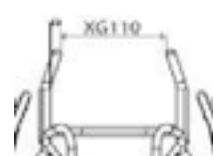
 XG120 Outward flare
 \$144.00
 (inside of backrest posts)

Specify width or per side
 mm



CASTERS AND REAR WHEELS

Caster Options

- | | |
|--|---|
| <input type="checkbox"/> XC160 Sport 61mm caster
(Std, Black) | <input type="checkbox"/> XC181 Bones Reds bearings
(All caster bearings) |
| <input type="checkbox"/> XC170 Sport 72mm caster (Black)
\$197.00 | <input type="checkbox"/> XC182 Bones Swiss Ceramic bearings
\$592.00 (All caster bearings) |

Rear Wheel Size

- | | | | |
|---|---|---|--|
| <input type="checkbox"/> XY420 24" Wheels | <input type="checkbox"/> XY430 25" Wheels | <input type="checkbox"/> XY440 26" Wheels | <input type="checkbox"/> XY450 700C Wheels |
|---|---|---|--|

Rear Wheel Gap

<input type="checkbox"/> XY460 Rear wheel gap 	OR	<input type="checkbox"/> XY470 Inside to inside of wheel
---	----	--

Rear Wheel Options

- | | |
|--|---|
| <input type="checkbox"/> XK030 Equalizer 36/48 spoke
(Black hub and spokes) | <input type="checkbox"/> XK100 Spinergy XSLX 24 spoke
\$1,044.00 |
| <input type="checkbox"/> XK080 Spinergy SLX 24 spoke
\$991.00 | <input type="checkbox"/> XK180 Individual spoke design
\$210.00
(Specify colour)
Inside: _____
Outside: _____ |
- Spinergy Colour Options:**
- | | | |
|--|--|--|
| <input type="checkbox"/> Black spokes | <input type="checkbox"/> White spokes | <input type="checkbox"/> Yellow spokes |
| <input type="checkbox"/> Red spokes | <input type="checkbox"/> Blue spokes | <input type="checkbox"/> Pink spokes |
| <input type="checkbox"/> Purple spokes | <input type="checkbox"/> Orange spokes | <input type="checkbox"/> Green spokes |
- Spinergy Anodize Options**
- | | | | |
|---|--|--|--|
| <input type="checkbox"/> XK190 Black hub NC
(std option) | <input type="checkbox"/> XK200 Silver hub
\$125.00 | <input type="checkbox"/> XK201 Red hub/rims
\$403.00 | <input type="checkbox"/> XK205 Individual hub/rims
\$560.00
Select colour: _____ |
| <input type="checkbox"/> XK202 Purple hub/rims
\$403.00 | <input type="checkbox"/> XK203 Blue hub/rims
\$403.00 | <input type="checkbox"/> XK204 Gold hub/rims
\$531.00 | |

Supply Without Wheels

- | | | |
|--|-------------------|-----------------|
| <input type="checkbox"/> XK040 Supply without Wheels | Wheel Type: _____ | Tire type _____ |
|--|-------------------|-----------------|

Handrim Position / Options

- | | |
|---|--|
| <input type="checkbox"/> XY480 Narrow set handrim | <input type="checkbox"/> XY485 Wide set handrim |
| <input type="checkbox"/> XL090 Remove excess mounting tabs
\$144.00 (recommended for small wheel gaps) | <input type="checkbox"/> XL080 Super narrow set handrim
\$290.00 (only with XL040 and includes XL090) |

Handrim Style

- | | |
|---|---|
| <input type="checkbox"/> XL010 Aluminium hard anodized 6 tab
(Select Colour) | <input type="checkbox"/> XL040 Titanium 6 tab (700C not available)
\$439.00 |
| <input type="checkbox"/> XL130 Aluminium hard anodized 6 tab painted
\$159.00 | <input type="checkbox"/> XL100 Para grip 6 tab (700C not available)
\$394.00 |
| <input type="checkbox"/> XL070 Aluminium hard anodized 12 tab (24" not available)
\$144.00 | <input type="checkbox"/> XL020 Tetra Grip 6 tab
\$394.00 |

Tire Options

- | | |
|--|--|
| <input type="checkbox"/> XM070 Kenda Kaliente <input type="checkbox"/> Red <input type="checkbox"/> Blue | <input type="checkbox"/> XM080 Tufo MS3 tubeless (Blue only)
\$80.00 |
| <input type="checkbox"/> XM150 IRC Exeracer Pro (Red Only)
\$1,385.00 | <input type="checkbox"/> XM090 Tufo WS3 tubeless (24" only and Blue only)
\$80.00 |

Spare Wheel

- | | |
|--|---|
| <input type="checkbox"/> GXAXK500 Spare wheel Spinergy (All inclusive + axle pin)
\$2,225 | <input type="checkbox"/> XK520 Spare wheel Titanium / Super narrow upcharge
\$625.00 |
|--|---|

Inner Tube Valve Options

- | | |
|---|---|
| <input type="checkbox"/> XY500 Schraeder inner tube valve | <input type="checkbox"/> XY490 Presta inner tube valve (Standard if no option selected) |
|---|---|

FINISH OPTIONS

 XN010 Powder coated frame

 XN150 Powder coated components *(Frame colour if not specified)*

 Frame Comp. Gloss

 Frame Comp. Matt

 Frame Comp. Special
 Black gloss 103

 Black matt 105

 Chrome Mirror 300

 White gloss 100

 White matt 101

 Sparkle silver 170

 Grey gloss 132

 Grey matt 131

 Metallic black matt 104

 Cream gloss 135

 Light grey matt 133

 Metallic grey matt 130

 Red gloss 108

 Navy blue matt 152

 Black sandpaper 201

 Yellow gloss 120

 Grey sandpaper 202

 Forest green gloss 143

 White sandpaper 200

 Green gloss 107

 Dark blue gloss 151

 Royal blue gloss 154

 Blue gloss 174

 Duckegg blue gloss 141

 Pink gloss 188

 Orange gloss 180

 Purple gloss 157

 RGK-XN200 Individual paint colour (State Colour/RAL code)
\$557.00

 Frame Comp
 GSAXN030 Brushed frame
\$557.00 *(All parts black unless XN160 chosen)*
 XN160 Brushed components
\$119.00 *(not required with fixed footrest & backrest)*
 GSAXN050 Polished frame
\$655.00 *(All parts black unless XN170 chosen)*
 XN170 Polished components
\$210.00 *(not required with fixed footrest & backrest)*

Accent Colour (Choose One)

Note: Accent colour includes forks, caster caps, decals

 Black accent
 Red accent
 Purple accent

 Silver accent
 Blue accent

 XN250 Individual accent colour
\$310.00

 Select Colour:

UPHOLSTERY

Seat Upholstery

 XP040 Seat sling strap adjustable *(not required with seatplate)*

Backrest Upholstery

 XP055 Airtech sport backrest strap adjustable

 XP070 Backrest upgrade to leather corners *(Black)*
\$119.00

Backrest Stitching Options

 Silver Black Blue Individual:
 Red Light blue Purple _____

Backrest RGK Logo Colour

 White (Std) Green Blue Individual:
 Red Light blue Purple _____

Backrest Accessories

 XP170 Individual backrest embroidery
\$236.00 *(Please provide .jpeg file and positioning)*

CUSHION

Cushion Foam Options

- XP080** Cushion foam
\$119.00 *(select density and size below)*
- Soft (CMS040) Medium (CMS050) Hard (9lb recon)
 50mm 75mm 100mm Other mm
- XP340** Plastazote cushion upgrade
\$113.00 *(Indicate max height)*

Cushion Cover Options

- XP081** Nylon cushion cover (Black)
- XP090** Air Lite cushion cover (Black) **XP380** Neoprene cushion cover (Black)
 \$97.00 \$125.00

STRAPS

Velcro straps

- XS050** 100mm Pro adjustable velcro strap
\$170.00
- XS055** 50mm Pro adjustable velcro strap
\$133.00
- XS057** 50mm Pro knee strap
\$246.00 *(measurement from tube to tube over knees)*

Velcro strap position

Strap 1



Specify strap length

 mm

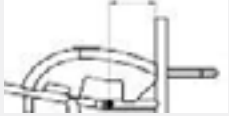

Specify distance from back post

 mm

Strap 1

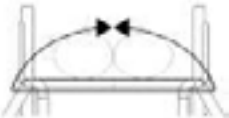

Specify strap length

 mm



Specify distance from back post

 mm

- XS020** Sport ratchet strap (Click strap)
\$138.00 *(11" x 2" pad)*
- XS025** Pelvi Loc 2DA ratchet strap
\$400.00 *(For thighs and knees)*
- XS030** Pelvi Loc 3DA ratchet strap
\$413.00 *(For hips)*
- XS035** M2 ratchet strap
\$279.00 *(For thighs and knees)*
- XS025 Select size:**
 Medium (8") Large (10")
- XS030 Select size:**
 Small (8") Medium (9")
 Large (10") Extra Large (11")
- XS035 Select size:**
 8" 10" 12"

Strap 1



Specify distance from back post

 mm

Strap 2

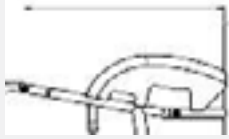

Specify distance from back post

 mm

XS040 Fixed mounting points
(one set per click strap) x1 x2 x3

XS045 Clamped mounting points
(one set per click strap) x1 x2 x3

FRAME OPTIONS

- XR060** Calf strap mounting loops
\$152.00 
- XR065** Strap location loops
\$116.00 

ACCESSORIES

- XR030** Triple wheel bag (Black)
\$198.00
- XP130** Frame protectors full length
\$125.00
- XS100** Bodypoint waist strap
\$101.00 Small Large
- XS070** Foot strap *(select if required)*
- XS060** Calf strap *(select if required)*
- XP400** Back bar protector
- XR090** Tool kit

