



### Customer Contact Details

Customer Name: _____	Ship to Customer Address: <input type="checkbox"/>
Advisor: _____	Shipping Name: _____
Address: _____	Shipping Address: _____
_____	_____
_____	_____
Phone: _____	Phone: _____
Email: _____	Email: _____

### Additional Information

Notes: _____	Current Wheelchair: _____
_____	Customer Weight: _____
_____	Customer Height: _____
_____	Customer Disability: _____

Guide:  Base product     Required option     Optional Extra    Critical Information    Information Needed

### PRODUCT STYLE

**TGAXZ010 TIGA**  
\$7,169.00

- XA070    Open design  
 XA080    Closed design

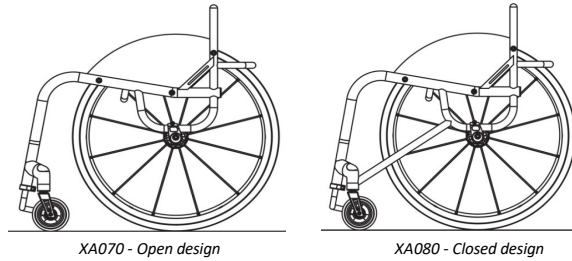

**Max User Weight 125kg (275lbs)**

Yes, I am within the max user weight

### CAD APPROVAL

- |  |   |
|--|---|
| <input type="checkbox"/> XW012 <b>QUOTE</b> CAD drawing for approval<br>\$550 FLAT FEE (Includes two free revisions) | <input type="checkbox"/> XW010 <b>ORDER</b> CAD drawing for approval.<br>\$300 FLAT FEE (Includes two free revisions) |
| <input type="checkbox"/> XW009 <b>QUOTE</b> only no CAD<br>\$0   | <input type="checkbox"/> XW011 <b>ORDER</b> only no CAD<br>\$0  |

### KEY MEASUREMENTS

- XY010    Seat width (*Inside to inside of sideguards*)  
SW  mm (Max - 500mm)
- mm
- XY020    Seat length  
 mm (Max - 500mm)
- mm
- XY030    Extra Seat Length (*Provides additional leg support & hand grip*)  
  mm
- XY050    Front frame height  
 mm (Max - 550mm)  
(Min - 380mm)
- mm
- XY060    Rear frame height  
 mm (Max - 550mm)  
(Min - 360mm)
- mm
- XY070    Frame length  
 mm (Min = XY020 + XY030 + 140mm)
- mm
- XY072    Caster position  
  mm  
 Optimize measurements     TX Forward Castor Position
- XA020    Ergonomic seat  
\$119.00  
  mm (Standard = 120mm)

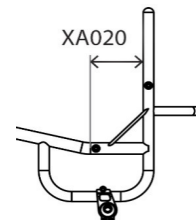
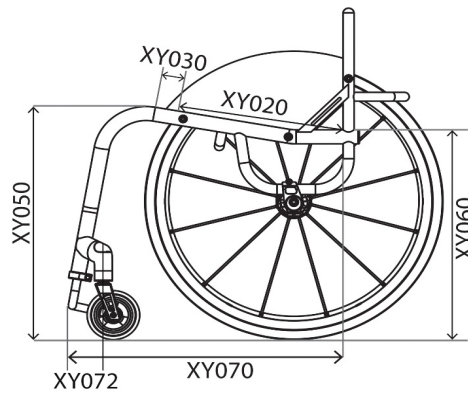
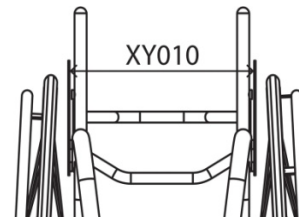

## FRONT FRAME AND FOOTREST

### Front Frame Options

 XY080 Seat taper design

**i** Specify width  mm

(When combined with XY091, dimension is inbetween the centre of the main bends)

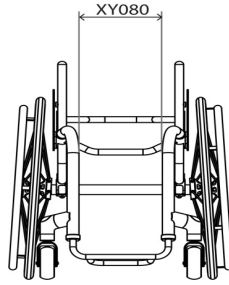
 XY091 Parallel taper design

**i** Specify width  mm

(When combined with XY080, dimensions must be smaller by 20mm)

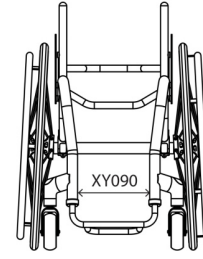

### Footrest Design (Choose One)

 XY100 Round design

Caster Size	Max Height	With XB200
3"	115mm	165mm
4"	125mm	175mm
5"	135mm	185mm

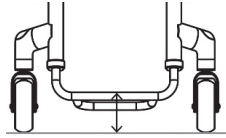
 XY105 Square design

Caster Size	Max Height	With XB200
3"	135mm	185mm
4"	145mm	195mm
5"	155mm	205mm

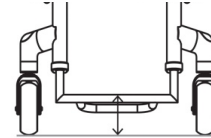
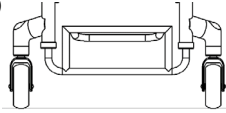
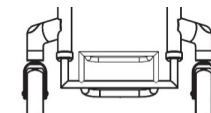
 XB200 High level footrest (Only with \$198.00 XB010, XB080 & XB150)

 XB200 High level footrest (Only with XB010, XB080 & \$198.00 XB150)

### Footrest Individual Measurements

 XY115 Front footrest height

**!**  mm

 XY120 Rear footrest height

**i**  mm (Std = 20 lower than front height)

 XY125 Footrest length

**i**  mm (Std = 100mm) (160mm and over requires heavy duty upgrade XB150)

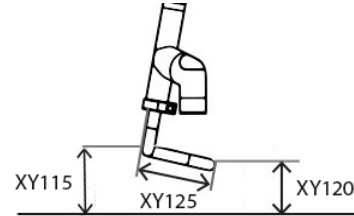

### Footrest Style (Choose One)

 XB010 Tubular aluminium footrest (Height adjustable)

 XB030 Flip up plastic footrest \$347.00 (Angle/height adjustable, with closed frame only)

 XB070 Angle adjustable aluminium footrest \$204.00 (Angle/height adjustable)

 XB150 Heavy duty tubular footrest \$177.00 (Height adjustable, for Freewheel use)

 TGAXB080 Tubular footrest welded into frame \$101.00 (No height adjustment)

### Footrest Cover

 XB050 Carbon fibre cover \$244.00 (Not with XB070 & XB030)

 XB170 Aluminium cover \$97.00 (Not with XB070 & XB030)

 XB040 Plastic Cover \$97.00 (Not with XB070 & XB030)

 XB165 Rubber grip tape \$85.00 (3M Safety walk)(not with XB030)

CASTER WHEELS, FORKS & WHEEL LOCKS	
Caster Wheels	
75mm (3")	
<input type="checkbox"/> XC150 Aluminium centre 3"x1.4" \$229.00 (Silver hub and black urethane tire)	
100mm (4")	
<input type="checkbox"/> XC060 Soft roll 4"x1.3" (Black)	
<input type="checkbox"/> XC110 Aluminium centre 4"x1" \$229.00 (Silver hub and black urethane tire)	
<input type="checkbox"/> XC130 Aluminium centre 4"x1.4" \$229.00 (choose colour below)	
<div style="display: flex; justify-content: space-between;"> <div style="width: 20%;"> <input type="checkbox"/> Silver hub &amp; black tire (Std)                             </div> <div style="width: 20%;"> <input type="checkbox"/> Black hub &amp; blue tire                             </div> <div style="width: 20%;"> <input type="checkbox"/> Purple hub &amp; black tire                             </div> <div style="width: 20%;"> <input type="checkbox"/> Silver hub &amp; blue tire                             </div> </div> <div style="display: flex; justify-content: space-between; margin-top: 5px;"> <div style="width: 20%;"> <input type="checkbox"/> Black hub &amp; black tire                             </div> <div style="width: 20%;"> <input type="checkbox"/> Red hub &amp; black tire                             </div> <div style="width: 20%;"> <input type="checkbox"/> Gold hub &amp; black tire                             </div> <div style="width: 20%;"> <input type="checkbox"/> Silver hub &amp; red tire                             </div> </div> <div style="display: flex; justify-content: space-between; margin-top: 5px;"> <div style="width: 20%;"> <input type="checkbox"/> Black hub &amp; red tire                             </div> <div style="width: 20%;"> <input type="checkbox"/> Blue hub &amp; black tire                             </div> <div style="width: 20%;"> <input type="checkbox"/> Green hub &amp; black tire                             </div> </div>	
125mm (5")	
<input type="checkbox"/> XC070 Soft roll 5"x1.3" (Black)	<input type="checkbox"/> XC120 Aluminium centre 5"x1" \$229.00 (Silver hub and black urethane tire)
<input type="checkbox"/> XC100 Pneumatic Aluminium centre 5"x1" \$244.00 (Grey)	<input type="checkbox"/> XC140 Aluminium centre 5"x1.4" \$229.00 (Silver hub and black urethane tire)
150mm (6")	
<input type="checkbox"/> XC080 Soft roll 6"x1.3"	<input type="checkbox"/> XC145 Aluminium centre 6"x1.4" \$305.00 (Silver hub and black urethane tire)
200mm (8")	
<input type="checkbox"/> XC185 Pneumatic offroad 8"x2" \$305.00 (only with TX Forward castor position)	
Caster Forks	
<input type="checkbox"/> XC190 Low ride caster fork (Std when no option selected)	<input type="checkbox"/> XC210 Froglegs suspension caster fork \$624.00
Note: Colour follows accent <div style="float: right; margin-top: 5px;"> <input type="checkbox"/> Black    <input type="checkbox"/> Silver                 </div>	
Caster Pin Width	
<input checked="" type="checkbox"/> XY330 Caster pin width <div style="display: inline-block; border: 1px solid black; width: 100px; height: 20px; margin: 5px 0;"></div> mm <input type="checkbox"/> Optimize measurements	
Wheel Lock Options (choose one)	
<input type="checkbox"/> XD020 Underseat Scissor	<input type="checkbox"/> XD050 Push to lock
<input type="checkbox"/> XD030 Compact scissor \$262.00	<input type="checkbox"/> XD046 Out Front push to lock \$403.00
<input type="checkbox"/> XD035 Compact scissor with lightweight fixing \$347.00 (Only with fixed centre of gravity)	
<input type="checkbox"/> XD045 Out Front Compact scissor \$403.00	<input type="checkbox"/> XD010 Omit wheel locks

SIDEGUARDS AND ARMRESTS																																																																																																					
<table style="width: 100%; border-collapse: collapse;"> <tr> <th colspan="2" style="background-color: #eee; text-align: center; padding: 2px;">Sideguard</th> </tr> <tr> <th colspan="2" style="background-color: #eee; text-align: center; padding: 2px;">Aluminium Options</th> </tr> <tr> <td style="padding: 2px;"><input type="checkbox"/> XE030</td> <td style="padding: 2px;">Screw on aluminium \$322.00</td> </tr> <tr> <td style="padding: 2px;"><input type="checkbox"/> XE080</td> <td style="padding: 2px;">Lift out aluminium \$524.00</td> </tr> <tr> <td style="padding: 2px;"><input type="checkbox"/> TGAXE130</td> <td style="padding: 2px;">Fold flat aluminium \$498.00</td> </tr> <tr> <td style="padding: 2px;"><input type="checkbox"/> XE180</td> <td style="padding: 2px;">Flip back aluminium \$387.00</td> </tr> <tr> <td style="padding: 2px;"><input type="checkbox"/> TGAXE220</td> <td style="padding: 2px;">Welded with 6mm bead \$349.00</td> </tr> <tr> <td style="padding: 2px;"><input type="checkbox"/> TGAXE230</td> <td style="padding: 2px;">Welded aluminium sport <i>(Extra strong)</i> \$532.00</td> </tr> <tr> <th colspan="2" style="background-color: #eee; text-align: center; padding: 2px;">Carbon Fibre Options</th> </tr> <tr> <td style="padding: 2px;"><input type="checkbox"/> XE050</td> <td style="padding: 2px;">Screw on carbon fibre \$715.00</td> </tr> <tr> <td style="padding: 2px;"><input type="checkbox"/> XE100</td> <td style="padding: 2px;">Lift out carbon fibre \$755.00</td> </tr> <tr> <td style="padding: 2px;"><input type="checkbox"/> TGAXE150</td> <td style="padding: 2px;">Fold flat carbon fibre \$807.00</td> </tr> <tr> <td style="padding: 2px;"><input type="checkbox"/> XE200</td> <td style="padding: 2px;">Flip back carbon fibre \$591.00</td> </tr> <tr> <th colspan="2" style="background-color: #eee; text-align: center; padding: 2px;">ABS Plastic Options</th> </tr> <tr> <td style="padding: 2px;"><input type="checkbox"/> XE070</td> <td style="padding: 2px;">Screw on ABS plastic \$165.00</td> </tr> <tr> <td style="padding: 2px;"><input type="checkbox"/> XE120</td> <td style="padding: 2px;">Lift out ABS plastic \$480.00</td> </tr> <tr> <td style="padding: 2px;"><input type="checkbox"/> TGAXE170</td> <td style="padding: 2px;">Fold flat ABS plastic \$455.00</td> </tr> <tr> <th colspan="2" style="background-color: #eee; text-align: center; padding: 2px;">Armrest Options</th> </tr> <tr> <td style="padding: 2px;"><input type="checkbox"/> XF010</td> <td style="padding: 2px;">Lift out armrest with plastic sideguard <i>(Indicate fixed height)</i> \$583.00</td> </tr> <tr> <td style="padding: 2px;"><input type="checkbox"/> XF020</td> <td style="padding: 2px;">Lift out armrest with Aluminium sideguard <i>(Indicate fixed height)</i> \$460.00</td> </tr> <tr> <td colspan="2" style="padding: 2px;"><i>Height (Top of seatrail to top of armrest)</i></td> </tr> <tr> <td style="padding: 2px;"><input type="checkbox"/> <input style="width: 80px;" type="text"/></td> <td style="padding: 2px; text-align: right;">mm</td> </tr> <tr> <th colspan="2" style="background-color: #eee; text-align: center; padding: 2px;">Sideguard Measurements</th> </tr> <tr> <th colspan="2" style="background-color: #eee; text-align: center; padding: 2px;">Optimized measurements</th> </tr> <tr> <td style="padding: 2px;"><input type="checkbox"/> 25mm above tire <i>(Follow tire)</i></td> <td rowspan="3" style="padding: 2px; text-align: center;"></td> </tr> <tr> <td style="padding: 2px;"><input type="checkbox"/> Individual above tire <i>(Follow tire)</i></td> </tr> <tr> <td style="padding: 2px;"><input type="checkbox"/> <input style="width: 80px;" type="text"/></td> </tr> <tr> <td style="padding: 2px;"><input type="checkbox"/> Level with tire <i>(Follow tire)</i></td> <td style="padding: 2px; text-align: center;"></td> </tr> <tr> <th colspan="2" style="background-color: #eee; text-align: center; padding: 2px;">Individual measurements</th> </tr> <tr> <td style="padding: 2px;"><input type="checkbox"/> Sideguard length</td> <td rowspan="3" style="padding: 2px; text-align: center;"></td> </tr> <tr> <td style="padding: 2px;"><input type="checkbox"/> <input style="width: 80px;" type="text"/></td> </tr> <tr> <td style="padding: 2px;"><input type="checkbox"/> Sideguard height</td> </tr> <tr> <td style="padding: 2px;"><input type="checkbox"/> <input style="width: 80px;" type="text"/></td> <td style="padding: 2px; text-align: right;">mm</td> </tr> </table>	Sideguard		Aluminium Options		<input type="checkbox"/> XE030	Screw on aluminium \$322.00	<input type="checkbox"/> XE080	Lift out aluminium \$524.00	<input type="checkbox"/> TGAXE130	Fold flat aluminium \$498.00	<input type="checkbox"/> XE180	Flip back aluminium \$387.00	<input type="checkbox"/> TGAXE220	Welded with 6mm bead \$349.00	<input type="checkbox"/> TGAXE230	Welded aluminium sport <i>(Extra strong)</i> \$532.00	Carbon Fibre Options		<input type="checkbox"/> XE050	Screw on carbon fibre \$715.00	<input type="checkbox"/> XE100	Lift out carbon fibre \$755.00	<input type="checkbox"/> TGAXE150	Fold flat carbon fibre \$807.00	<input type="checkbox"/> XE200	Flip back carbon fibre \$591.00	ABS Plastic Options		<input type="checkbox"/> XE070	Screw on ABS plastic \$165.00	<input type="checkbox"/> XE120	Lift out ABS plastic \$480.00	<input type="checkbox"/> TGAXE170	Fold flat ABS plastic \$455.00	Armrest Options		<input type="checkbox"/> XF010	Lift out armrest with plastic sideguard <i>(Indicate fixed height)</i> \$583.00	<input type="checkbox"/> XF020	Lift out armrest with Aluminium sideguard <i>(Indicate fixed height)</i> \$460.00	<i>Height (Top of seatrail to top of armrest)</i>		<input type="checkbox"/> <input style="width: 80px;" type="text"/>	mm	Sideguard Measurements		Optimized measurements		<input type="checkbox"/> 25mm above tire <i>(Follow tire)</i>		<input type="checkbox"/> Individual above tire <i>(Follow tire)</i>	<input type="checkbox"/> <input style="width: 80px;" type="text"/>	<input type="checkbox"/> Level with tire <i>(Follow tire)</i>		Individual measurements		<input type="checkbox"/> Sideguard length		<input type="checkbox"/> <input style="width: 80px;" type="text"/>	<input type="checkbox"/> Sideguard height	<input type="checkbox"/> <input style="width: 80px;" type="text"/>	mm	<table style="width: 100%; border-collapse: collapse;"> <tr> <th colspan="2" style="background-color: #eee; text-align: center; padding: 2px;">Sideguard with Fender</th> </tr> <tr> <th colspan="2" style="background-color: #eee; text-align: center; padding: 2px;">Aluminium Options</th> </tr> <tr> <td style="padding: 2px;"><input type="checkbox"/> XE040</td> <td style="padding: 2px;">Screw on aluminium with fender \$275.00</td> </tr> <tr> <td style="padding: 2px;"><input type="checkbox"/> XE090</td> <td style="padding: 2px;">Lift out aluminium with fender \$570.00</td> </tr> <tr> <td style="padding: 2px;"><input type="checkbox"/> TGAXE140</td> <td style="padding: 2px;">Fold flat aluminium with fender \$492.00</td> </tr> <tr> <td style="padding: 2px;"><input type="checkbox"/> XE190</td> <td style="padding: 2px;">Flip back aluminium with fender \$329.00</td> </tr> <tr> <th colspan="2" style="background-color: #eee; text-align: center; padding: 2px;">Carbon Fibre Options</th> </tr> <tr> <td style="padding: 2px;"><input type="checkbox"/> XE060</td> <td style="padding: 2px;">Screw on carbon fibre with fender \$938.00</td> </tr> <tr> <td style="padding: 2px;"><input type="checkbox"/> XE110</td> <td style="padding: 2px;">Lift out carbon fibre with fender \$1,115.00</td> </tr> <tr> <td style="padding: 2px;"><input type="checkbox"/> TGAXE160</td> <td style="padding: 2px;">Fold flat carbon fibre with fender \$900.00</td> </tr> <tr> <td style="padding: 2px;"><input type="checkbox"/> XE210</td> <td style="padding: 2px;">Flip back carbon fibre with fender \$735.00</td> </tr> <tr> <th colspan="2" style="background-color: #eee; text-align: center; padding: 2px;">Sideguard Measurements</th> </tr> <tr> <th colspan="2" style="background-color: #eee; text-align: center; padding: 2px;">Fender Height</th> </tr> <tr> <td style="padding: 2px;"><input type="checkbox"/> 10mm above tire <i>(Standard)</i></td> <td rowspan="3" style="padding: 2px; text-align: center;"></td> </tr> <tr> <td style="padding: 2px;"><input type="checkbox"/> Individual above tire <i>(Min = 10mm)</i></td> </tr> <tr> <td style="padding: 2px;"><input type="checkbox"/> <input style="width: 80px;" type="text"/></td> </tr> <tr> <td colspan="2" style="padding: 2px; text-align: right;">mm</td> </tr> <tr> <th colspan="2" style="background-color: #eee; text-align: center; padding: 2px;">Fender position</th> </tr> <tr> <td style="padding: 2px;"><input type="checkbox"/> Centre of tire <i>(Standard if no option selected)</i></td> <td style="padding: 2px; text-align: center;"></td> </tr> <tr> <td style="padding: 2px;"><input type="checkbox"/> Outside of tire</td> <td style="padding: 2px; text-align: center;"></td> </tr> </table>	Sideguard with Fender		Aluminium Options		<input type="checkbox"/> XE040	Screw on aluminium with fender \$275.00	<input type="checkbox"/> XE090	Lift out aluminium with fender \$570.00	<input type="checkbox"/> TGAXE140	Fold flat aluminium with fender \$492.00	<input type="checkbox"/> XE190	Flip back aluminium with fender \$329.00	Carbon Fibre Options		<input type="checkbox"/> XE060	Screw on carbon fibre with fender \$938.00	<input type="checkbox"/> XE110	Lift out carbon fibre with fender \$1,115.00	<input type="checkbox"/> TGAXE160	Fold flat carbon fibre with fender \$900.00	<input type="checkbox"/> XE210	Flip back carbon fibre with fender \$735.00	Sideguard Measurements		Fender Height		<input type="checkbox"/> 10mm above tire <i>(Standard)</i>		<input type="checkbox"/> Individual above tire <i>(Min = 10mm)</i>	<input type="checkbox"/> <input style="width: 80px;" type="text"/>	mm		Fender position		<input type="checkbox"/> Centre of tire <i>(Standard if no option selected)</i>		<input type="checkbox"/> Outside of tire	
Sideguard																																																																																																					
Aluminium Options																																																																																																					
<input type="checkbox"/> XE030	Screw on aluminium \$322.00																																																																																																				
<input type="checkbox"/> XE080	Lift out aluminium \$524.00																																																																																																				
<input type="checkbox"/> TGAXE130	Fold flat aluminium \$498.00																																																																																																				
<input type="checkbox"/> XE180	Flip back aluminium \$387.00																																																																																																				
<input type="checkbox"/> TGAXE220	Welded with 6mm bead \$349.00																																																																																																				
<input type="checkbox"/> TGAXE230	Welded aluminium sport <i>(Extra strong)</i> \$532.00																																																																																																				
Carbon Fibre Options																																																																																																					
<input type="checkbox"/> XE050	Screw on carbon fibre \$715.00																																																																																																				
<input type="checkbox"/> XE100	Lift out carbon fibre \$755.00																																																																																																				
<input type="checkbox"/> TGAXE150	Fold flat carbon fibre \$807.00																																																																																																				
<input type="checkbox"/> XE200	Flip back carbon fibre \$591.00																																																																																																				
ABS Plastic Options																																																																																																					
<input type="checkbox"/> XE070	Screw on ABS plastic \$165.00																																																																																																				
<input type="checkbox"/> XE120	Lift out ABS plastic \$480.00																																																																																																				
<input type="checkbox"/> TGAXE170	Fold flat ABS plastic \$455.00																																																																																																				
Armrest Options																																																																																																					
<input type="checkbox"/> XF010	Lift out armrest with plastic sideguard <i>(Indicate fixed height)</i> \$583.00																																																																																																				
<input type="checkbox"/> XF020	Lift out armrest with Aluminium sideguard <i>(Indicate fixed height)</i> \$460.00																																																																																																				
<i>Height (Top of seatrail to top of armrest)</i>																																																																																																					
<input type="checkbox"/> <input style="width: 80px;" type="text"/>	mm																																																																																																				
Sideguard Measurements																																																																																																					
Optimized measurements																																																																																																					
<input type="checkbox"/> 25mm above tire <i>(Follow tire)</i>																																																																																																					
<input type="checkbox"/> Individual above tire <i>(Follow tire)</i>																																																																																																					
<input type="checkbox"/> <input style="width: 80px;" type="text"/>																																																																																																					
<input type="checkbox"/> Level with tire <i>(Follow tire)</i>																																																																																																					
Individual measurements																																																																																																					
<input type="checkbox"/> Sideguard length																																																																																																					
<input type="checkbox"/> <input style="width: 80px;" type="text"/>																																																																																																					
<input type="checkbox"/> Sideguard height																																																																																																					
<input type="checkbox"/> <input style="width: 80px;" type="text"/>	mm																																																																																																				
Sideguard with Fender																																																																																																					
Aluminium Options																																																																																																					
<input type="checkbox"/> XE040	Screw on aluminium with fender \$275.00																																																																																																				
<input type="checkbox"/> XE090	Lift out aluminium with fender \$570.00																																																																																																				
<input type="checkbox"/> TGAXE140	Fold flat aluminium with fender \$492.00																																																																																																				
<input type="checkbox"/> XE190	Flip back aluminium with fender \$329.00																																																																																																				
Carbon Fibre Options																																																																																																					
<input type="checkbox"/> XE060	Screw on carbon fibre with fender \$938.00																																																																																																				
<input type="checkbox"/> XE110	Lift out carbon fibre with fender \$1,115.00																																																																																																				
<input type="checkbox"/> TGAXE160	Fold flat carbon fibre with fender \$900.00																																																																																																				
<input type="checkbox"/> XE210	Flip back carbon fibre with fender \$735.00																																																																																																				
Sideguard Measurements																																																																																																					
Fender Height																																																																																																					
<input type="checkbox"/> 10mm above tire <i>(Standard)</i>																																																																																																					
<input type="checkbox"/> Individual above tire <i>(Min = 10mm)</i>																																																																																																					
<input type="checkbox"/> <input style="width: 80px;" type="text"/>																																																																																																					
mm																																																																																																					
Fender position																																																																																																					
<input type="checkbox"/> Centre of tire <i>(Standard if no option selected)</i>																																																																																																					
<input type="checkbox"/> Outside of tire																																																																																																					

<b>BACKREST</b>	
<b>Backrest Height</b>	
<input type="checkbox"/> XY230 Fixed height backrest Specify height <input style="width: 100px;" type="text"/> mm 	<input type="checkbox"/> XY245 Adjustable height backrest \$244.00 (+/-25mm) Specify height <input style="width: 100px;" type="text"/> mm 
<b>Backrest Design</b>	
<input type="checkbox"/> XG010 Fixed backrest (Non-folding)	<input type="checkbox"/> TGAXG020 Folding backrest \$467.00 (with 2 position snap lock and angle adjust ± 5 Deg)
<b>Ergonomic Options</b>	
<input checked="" type="checkbox"/> XY360 Backrest angle -5 -3 0 +3 +5 Individual <input style="width: 100px;" type="text"/> mm (Max -10/+20 Deg) 	<input type="checkbox"/> XG100 Ergonomic backrest \$144.00 Vertical height <input style="width: 100px;" type="text"/> mm Rearward position <input style="width: 100px;" type="text"/> mm 
<input type="checkbox"/> XG110 Inward taper \$144.00 (inside of backrest posts) Specify width or per side <input style="width: 100px;" type="text"/> mm 	<input type="checkbox"/> XG120 Outward flare \$144.00 (inside of backrest posts) Specify width or per side <input style="width: 100px;" type="text"/> mm 
<b>Push handle Options</b>	
<input type="checkbox"/> XG070 Screw in push handles \$222.00 (N/A with XY245)	<input type="checkbox"/> XG090 Stroller push handles height adjustable \$434.00 Height from floor to top of handles <input style="width: 100px;" type="text"/> mm <input type="checkbox"/> Optimize (1000mm from floor)
<input type="checkbox"/> XG080 Flip down push handles \$434.00 (N/A with XY245)	<input type="checkbox"/> XG097 Integrated push handle \$666.00 (Quickie design)
<input type="checkbox"/> XG085 Flip down push handles height adjustable \$709.00 (N/A with XY245)	
<b>Backrest Options</b>	
<input type="checkbox"/> XG040 Heavy duty backrest upgrade \$204.00 (Recommended for hand cycling) (Not with XY245)	<input type="checkbox"/> XG130 Extra deep Square brace bar \$113.00 (Recommended for JAY backs) (Std - 90mm) Depth <input style="width: 100px;" type="text"/> mm
<b>ILSA Backrest Options</b>	
<input type="checkbox"/> XG140 Integrated lateral support \$472.00 A - Left <input style="width: 100px;" type="text"/> mm A - Right <input style="width: 100px;" type="text"/> mm B - Left <input style="width: 100px;" type="text"/> mm B - Right <input style="width: 100px;" type="text"/> mm C - Left <input style="width: 100px;" type="text"/> mm C - Right <input style="width: 100px;" type="text"/> mm D - Left <input style="width: 100px;" type="text"/> mm D - Right <input style="width: 100px;" type="text"/> mm	

CAMBER BAR	
<p style="text-align: center; background-color: #eee; margin-bottom: 5px;">Adjustable Centre of Gravity</p> <p><input type="checkbox"/> XH110 Square back adjustable centre of gravity (25-150mm)</p> <div style="display: flex; align-items: center; margin-top: 10px;"> <div style="margin-right: 10px;"> </div> <div style="border: 1px solid black; padding: 2px;">Specify measurement</div> <div style="border: 1px solid black; width: 80px; height: 20px; margin-left: 5px; text-align: center;">mm</div> </div> <div style="text-align: right; margin-top: 10px;"> </div> <p><input type="checkbox"/> XH120 Round back adjustable centre of gravity (60-150mm)</p> <div style="display: flex; align-items: center; margin-top: 10px;"> <div style="margin-right: 10px;"> </div> <div style="border: 1px solid black; padding: 2px;">Specify measurement</div> <div style="border: 1px solid black; width: 80px; height: 20px; margin-left: 5px; text-align: center;">mm</div> </div> <div style="text-align: right; margin-top: 10px;"> </div>	<p style="text-align: center; background-color: #eee; margin-bottom: 5px;">Fixed Centre of Gravity</p> <p><input type="checkbox"/> TGAXH100 Single post fixed centre of gravity (25-125mm) \$604.00 <i>(Open frame only)</i> <i>(Not with Crash test option)</i></p> <div style="display: flex; align-items: center; margin-top: 10px;"> <div style="margin-right: 10px;"> </div> <div style="border: 1px solid black; padding: 2px;">Specify measurement</div> <div style="border: 1px solid black; width: 80px; height: 20px; margin-left: 5px; text-align: center;">mm</div> </div> <div style="text-align: right; margin-top: 10px;"> </div> <p><input type="checkbox"/> TGAXH090 V-style fixed centre of gravity (25-125mm) \$604.00</p> <div style="display: flex; align-items: center; margin-top: 10px;"> <div style="margin-right: 10px;"> </div> <div style="border: 1px solid black; padding: 2px;">Specify measurement</div> <div style="border: 1px solid black; width: 80px; height: 20px; margin-left: 5px; text-align: center;">mm</div> </div> <div style="text-align: right; margin-top: 10px;"> </div>
<p style="text-align: center; background-color: #eee; margin-bottom: 5px;">Specify Camber Angle</p> <p><input checked="" type="checkbox"/> XY390 Camber angle</p> <div style="display: flex; align-items: center; margin-top: 10px;"> <div style="margin-right: 10px;"> </div> <div style="display: flex; gap: 5px;"> <input type="checkbox"/> 0             <input type="checkbox"/> 1             <input type="checkbox"/> 2             <input type="checkbox"/> 3             <input type="checkbox"/> 5         </div> </div>	<p style="text-align: center; background-color: #eee; margin-bottom: 5px;">Specify Camber Angle</p> <p><input checked="" type="checkbox"/> XY390 Camber angle</p> <div style="display: flex; align-items: center; margin-top: 10px;"> <div style="margin-right: 10px;"> </div> <div style="display: flex; gap: 5px;"> <input type="checkbox"/> 0             <input type="checkbox"/> 1             <input type="checkbox"/> 2             <input type="checkbox"/> 3             <input type="checkbox"/> 5         </div> </div>
<p style="text-align: center; background-color: #eee; margin-bottom: 5px;">Camber Bar Options</p> <p><input type="checkbox"/> XH040 Handbike camber bar fixed \$394.00</p> <div style="margin-top: 10px;"> <p> Camber angle (Handbike camber bar)</p> <div style="display: flex; gap: 10px;"> <input type="checkbox"/> 0             <input type="checkbox"/> 5         </div> </div> <div style="margin-top: 10px;"> <p> Caster height from floor for handbike fitting (Standard 30mm if not indicated)</p> <div style="display: flex; gap: 10px;"> <input type="checkbox"/> 30             <input type="checkbox"/> 50         </div> </div> <p><input type="checkbox"/> XH030 Froglegs suspension camber bar \$841.00</p>	<p style="text-align: center; background-color: #eee; margin-bottom: 5px;">Camber Bar Options</p> <p><input type="checkbox"/> XH040 Handbike camber bar fixed \$394.00</p> <div style="margin-top: 10px;"> <p> Camber angle (Handbike camber bar)</p> <div style="display: flex; gap: 10px;"> <input type="checkbox"/> 0             <input type="checkbox"/> 5         </div> </div> <div style="margin-top: 10px;"> <p> Caster height from floor for handbike fitting (Standard 30mm if not indicated)</p> <div style="display: flex; gap: 10px;"> <input type="checkbox"/> 30             <input type="checkbox"/> 50         </div> </div>
Anti-Tip Options	
<p><input type="checkbox"/> XJ010 Swingaway anti tip LEFT side (Only with square back frame. Not with XH040) \$165.00</p> <p><input type="checkbox"/> XJ020 Swingaway anti tip RIGHT side (Only with square back frame. Not with XH040) \$165.00</p>	<p><input type="checkbox"/> XJ100 Single sport anti tip (centre mounted) \$497.00</p>

REAR WHEELS	
Rear Wheel Size	
<input type="checkbox"/> XY420 24" Wheels	<input type="checkbox"/> XY430 25" Wheels
Rear Wheel Gap	
<div style="display: flex; align-items: center;"> <div style="margin-right: 20px;"> <input checked="" type="checkbox"/> XY460 Rear wheel gap   15 <input type="checkbox"/> 20 <input type="checkbox"/> 25                  Individual <input style="width: 100px;" type="text"/> mm             </div> <div style="margin-left: 20px;"> </div> </div>	
Rear Wheel Options	
<input type="checkbox"/> XK010 Fusion 16 spoke <i>(Silver Hub, black spokes)</i> <input type="checkbox"/> XK050 Spinerger LX 12 spoke \$985.00 <input type="checkbox"/> XK150 Spinerger CLX 18 carbon blade spoke \$3,093.00 <b>Spinerger Colour Options:</b>	<input type="checkbox"/> XK320 Spinerger XLX 12 spoke, cross/radial spoked \$1,051.00 <input type="checkbox"/> XK060 Spinerger SPOX 18 spoke \$655.00 <input type="checkbox"/> XK070 Spinerger BLXL 18 blade spoke \$1,051.00 <i>(N/A in silver hub)</i> <input type="checkbox"/> XK180 Individual spoke design \$210.00 <i>Specify colour</i> Inside: _____ Outside: _____
<input type="checkbox"/> Black spokes <input type="checkbox"/> White spokes <input type="checkbox"/> Yellow spokes <input type="checkbox"/> Red spokes <input type="checkbox"/> Blue spokes <input type="checkbox"/> Pink spokes <input type="checkbox"/> Purple spokes <input type="checkbox"/> Orange spokes <input type="checkbox"/> Green spokes	
<b>Spinerger Anodise Options</b> <input type="checkbox"/> XK190 Black hub (std option) <input type="checkbox"/> XK200 Silver hub \$125.00 <i>(n/a with BLXL/CLX)</i> <input type="checkbox"/> XK201 Red hub/rims \$403.00 <i>(LX, XLX &amp; BLXL only)</i> <input type="checkbox"/> XK205 Individual hub/rims \$560.00 Select colour: <input type="checkbox"/> XK202 Purple hub/rims \$403.00 <i>(LX, XLX &amp; BLXL only)</i> <input type="checkbox"/> XK203 Blue hub/rims \$403.00 <i>(LX, XLX &amp; BLXL only)</i> <input type="checkbox"/> XK204 Gold hub/rims \$531.00 <i>(LX, XLX &amp; BLXL only)</i>	
Supply Without Wheels	
<input type="checkbox"/> XK040 Supply without Wheels	Wheel Type: <input style="width: 150px;" type="text"/> Tire Type: <input style="width: 150px;" type="text"/>
Handrim Position / Options	
<input type="checkbox"/> XY480 Narrow set handrim	<input type="checkbox"/> XY485 Wide set handrim
<input type="checkbox"/> XL090 Remove excess mounting tabs \$144.00 <i>(recommended for small wheel gaps)</i>	
Handrim Styles	
<input type="checkbox"/> XL010 Aluminium hard anodised 6 tab <i>(Standard if no option selected)</i>	<input type="checkbox"/> XL040 Titanium 6 tab \$439.00
<input type="checkbox"/> XL020 Tetra grip 6 tab \$394.00	<input type="checkbox"/> XL050 Stainless steel 6 tab \$244.00
<input type="checkbox"/> XL100 Para grip 6 tab \$394.00	
Tire Options	
<input type="checkbox"/> XM010 Kenda	<input type="checkbox"/> Grey <input type="checkbox"/> Blue <input type="checkbox"/> Red
<input type="checkbox"/> XM130 Kenda black \$27.00	
<input type="checkbox"/> XM020 Schwalbe Marathon Plus \$97.00	<input type="checkbox"/> XM060 Schwalbe One <i>(24",25" only)</i> \$131.00
<input type="checkbox"/> XM040 Shox solid airless (Black) \$158.00	<input type="checkbox"/> XM050 Kenda K885 mountain bike tire <i>(24",25" only)</i> \$39.00
Inner Tube Valve Options	
<input type="checkbox"/> XY500 Schraeder inner tube valve <i>(Standard if no option selected)</i>	<input type="checkbox"/> XY490 Presta inner tube valve
Wheel Accessories	
<input type="checkbox"/> XK310 Offroad wheel set 24" rim with handrim, MTB tire and axle pins (Replaces 25" wheel with XM010) \$919.00	<input type="checkbox"/> XK300 Offroad wheel set 22" rim with handrim, MTB tire and axle pins (Replaces 24" wheel with XM010) \$919.00



FINISH OPTIONS					
Frame & Component Finish					
<input type="checkbox"/> XN010 Powder coated frame		<input type="checkbox"/> XN150 Powder coated components <i>(Frame colour if not specified)</i>			
<i>Frame</i>	<i>Comp.</i>	<i>Gloss</i>	<i>Frame</i>	<i>Comp.</i>	<i>Matt</i>
<input type="checkbox"/>	<input type="checkbox"/>	Black gloss 103	<input type="checkbox"/>	<input type="checkbox"/>	Black matt 105
<input type="checkbox"/>	<input type="checkbox"/>	White gloss 100	<input type="checkbox"/>	<input type="checkbox"/>	White matt 101
<input type="checkbox"/>	<input type="checkbox"/>	Grey gloss 132	<input type="checkbox"/>	<input type="checkbox"/>	Grey matt 131
<input type="checkbox"/>	<input type="checkbox"/>	Cream gloss 135	<input type="checkbox"/>	<input type="checkbox"/>	Light grey matt 133
<input type="checkbox"/>	<input type="checkbox"/>	Red gloss 108	<input type="checkbox"/>	<input type="checkbox"/>	Navy blue matt 152
<input type="checkbox"/>	<input type="checkbox"/>	Yellow gloss 120		<input type="checkbox"/>	Black sandpaper 201
<input type="checkbox"/>	<input type="checkbox"/>	Forest green gloss 143		<input type="checkbox"/>	Grey sandpaper 202
<input type="checkbox"/>	<input type="checkbox"/>	Green gloss 107		<input type="checkbox"/>	White sandpaper 200
<input type="checkbox"/>	<input type="checkbox"/>	Dark blue gloss 151			
<input type="checkbox"/>	<input type="checkbox"/>	Royal blue gloss 154			
<input type="checkbox"/>	<input type="checkbox"/>	Blue gloss 174			
<input type="checkbox"/>	<input type="checkbox"/>	Duckegg blue gloss 141			
<input type="checkbox"/>	<input type="checkbox"/>	Pink gloss 188			
<input type="checkbox"/>	<input type="checkbox"/>	Orange gloss 180			
<input type="checkbox"/>	<input type="checkbox"/>	Purple gloss 157			
<input type="checkbox"/> TGAXN030	Brushed frame		<input type="checkbox"/> XN160	Brushed components	
\$557.00	<i>(All parts black unless XN160 chosen)</i>		\$119.00		
<input type="checkbox"/> TGAXN050	Polished frame		<input type="checkbox"/> XN170	Polished components	
\$1,292.00	<i>(All parts black unless XN170 chosen)</i>		\$210.00		
<input type="checkbox"/> RGK-XN200 Individual paint colour (State Colour/RAL code)					
\$557.00					
_____					
		Frame			Components
		<input type="checkbox"/>			<input type="checkbox"/>
Accent Colour					
<b>Note:</b> Accent colour includes, forks, clamps & castor caps.					
	<input type="checkbox"/> Black accent	<input type="checkbox"/> Silver accent	<input type="checkbox"/> RGK-XN250 Individual Accent Colour		
	<input type="checkbox"/> Red accent	<input type="checkbox"/> Blue accent	\$310.00		
	<input type="checkbox"/> Purple accent	<input type="checkbox"/> Carbon accent	_____		
<i>(Castor caps only, black for rest)</i>					
UPHOLSTERY					
Seat Upholstery					
<input type="checkbox"/> XP040	Seat sling adjustable tension with straps	<input type="checkbox"/> XR050	Carbon fibre seat plate		
		\$473.00			
Backrest Upholstery					
<input type="checkbox"/> XP050	Airtech backrest strap adjustable	<input type="checkbox"/> XP070	Backrest upgrade to leather corners (Black)		
		\$119.00			
Backrest Stitching Options					
<input type="checkbox"/> Silver	<input type="checkbox"/> Black	<input type="checkbox"/> Blue	<input type="checkbox"/> Individual: _____		
<input type="checkbox"/> Red	<input type="checkbox"/> Light blue	<input type="checkbox"/> Purple	_____		
Backrest RGK Logo Colour					
<input type="checkbox"/> White (Std)	<input type="checkbox"/> Green	<input type="checkbox"/> Blue	<input type="checkbox"/> Individual: _____		
<input type="checkbox"/> Red	<input type="checkbox"/> Light blue	<input type="checkbox"/> Purple	_____		
Backrest Accessories					
<input type="checkbox"/> XP110	Backrest with zip pocket	<input type="checkbox"/> XP170	Individual backrest embroidery		
\$125.00		\$236.00	<i>(Provide .jpeg file and positioning)</i>		

CUSHION	
Cushion foam options	
<input type="checkbox"/> XP080 \$119.00	Cushion foam <i>(select density and size below)</i>
<input type="checkbox"/> Soft (CMS040) <input type="checkbox"/> 50mm	<input type="checkbox"/> Medium (CMS050) <input type="checkbox"/> 75mm
	<input type="checkbox"/> Hard (9lb recon) <input type="checkbox"/> 100mm
Cushion Cover Upgrades	
<input type="checkbox"/> XP081 \$97.00	Nylon cushion cover <i>(Black)</i>
<input type="checkbox"/> XP090 \$97.00	Air Lite cushion cover <i>(Black)</i>
<input type="checkbox"/> XP100 \$250.00	Leather cushion cover <i>(Black)</i>
Jay Products	
<input type="checkbox"/> JAY Cushion <i>(Price dependant on size / option)</i>	<input type="checkbox"/> <i>Jay Order form attached</i>
<input type="checkbox"/> JAY Backrest <i>(Price dependant on size / option)</i>	<input type="checkbox"/> <i>Jay Order form attached</i>
<input type="checkbox"/> JAY Whitmyer Headrest <i>(Price dependant on size / option)</i>	<input type="checkbox"/> <i>Jay Order form attached</i>
<div style="border: 1px solid black; height: 80px; width: 100%;"></div>	
FRAME OPTIONS	
<input type="checkbox"/> XR060 \$152.00	Welded calf strap mounting loops <i>(To locate calf strap on front frame)</i>
	Specify height from floor <input style="width: 100px; height: 20px;" type="text"/>
<input type="checkbox"/> Optimize measurements	
ACCESSORIES	
<input type="checkbox"/> XR080 \$1,037.00	Frontwheel assembly <i>(Only with Tubular style footrest)</i>
<input type="checkbox"/> XP120 \$83.00	Frame protectors Neoprene zip fasten with TIGA logo <i>(Black)</i>
<input type="checkbox"/> XP420 \$80.00	Frame protectors Nylon velcro fasten <i>(Black)</i>
<input type="checkbox"/> XR010 \$58.00	Seat pouch velcro attach <i>(Black)</i>
<input type="checkbox"/> XR200 \$149.00	Rucksack with RGK logo (Black)
<input type="checkbox"/> XR020 \$125.00	Underseat large storage bag <i>(Black)</i>
<input checked="" type="checkbox"/> XA020	Tool kit
<input checked="" type="checkbox"/> XS060	Calf strap

## NOTES