



### Customer Contact Details

Customer Name: _____ Advisor: _____ Address: _____ _____ _____ Phone: _____ Email: _____	Ship to Customer Address: <input type="checkbox"/> Shipping Name: _____ Shipping Address: _____ _____ _____ Phone: _____ Email: _____
--	---

### Additional Information

Notes: _____ _____ _____ _____	Current Wheelchair: _____ Customer Weight: _____ Customer Height: _____ Customer Disability: _____
---	---

Guide:  Base product     Required option     Optional Extra    Critical Information    Information Needed

### PRODUCT STYLE

**TGAXZ010 TIGA**  
\$7,458.00

- XA070 Open design  
 XA080 Closed design

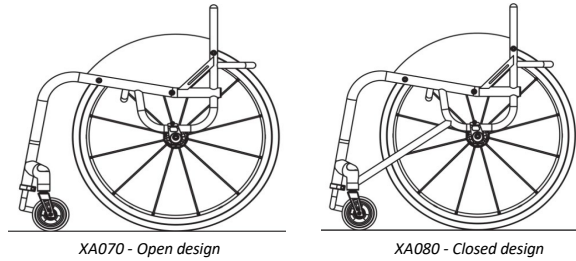

**Max User Weight 125kg (275lbs)**

Yes, I am within the max user weight

### CAD APPROVAL

- |  |   |
|--|---|
| <input type="checkbox"/> XW012 <b>QUOTE</b> CAD drawing for approval<br>\$550 FLAT FEE (Includes two free revisions) | <input type="checkbox"/> XW010 <b>ORDER</b> CAD drawing for approval.<br>\$300 FLAT FEE (Includes two free revisions) |
| <input type="checkbox"/> XW009 <b>QUOTE</b> only no CAD<br>\$0   | <input type="checkbox"/> XW011 <b>ORDER</b> only no CAD<br>\$0  |

### KEY MEASUREMENTS

- XY010 Seat width (*Inside to inside of sideguards*)  
SW  mm (Max - 500mm)
- XY020 Seat length  
 mm (Max - 500mm)
- XY030 Extra Seat Length (*Provides additional leg support & hand grip*)  
  mm
- XY050 Front frame height  
 mm (Max - 550mm) (Min - 380mm)
- XY060 Rear frame height  
 mm (Max - 550mm) (Min - 360mm)
- XY070 Frame length  
 mm (Min = XY020 + XY030 + 140mm)
- XY072 Caster position  
  mm  
 Optimize measurements     TX Forward Castor Position
- XA020 Ergonomic seat  
\$121.00  
Specify length  mm (Standard = 120mm)

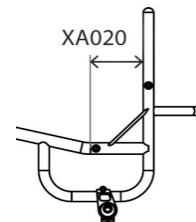
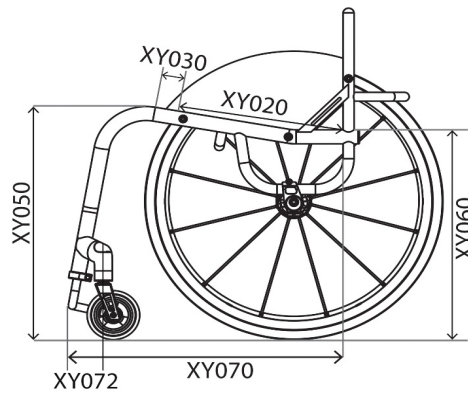
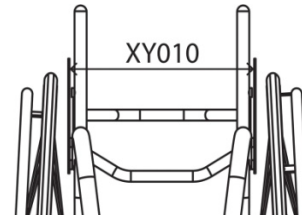

## FRONT FRAME AND FOOTREST

### Front Frame Options

- XY080 Seat taper design

**i** Specify width  mm

(When combined with XY091, dimension is inbetween the centre of the main bends)

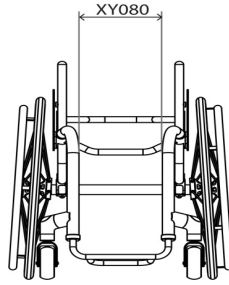

- XY091 Parallel taper design

**i** Specify width  mm

(When combined with XY080, dimensions must be smaller by 20mm)

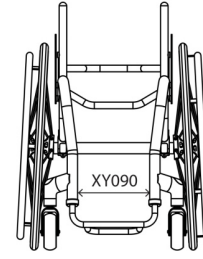

### Footrest Design (Choose One)

- XY100 Round design

Caster Size	Max Height	With XB200
3"	115mm	165mm
4"	125mm	175mm
5"	135mm	185mm

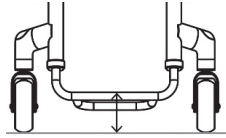

- XY105 Square design

Caster Size	Max Height	With XB200
3"	135mm	185mm
4"	145mm	195mm
5"	155mm	205mm

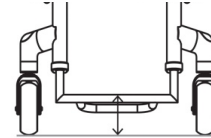

- XB200 High level footrest (Only with \$201.00 XB010, XB080 & XB150)

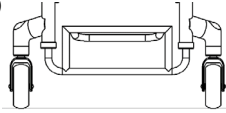

- XB200 High level footrest (Only with XB010, XB080 & \$201.00 XB150)

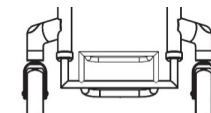

### Footrest Individual Measurements

- XY115 Front footrest height

**!**  mm

- XY120 Rear footrest height

**i**  mm (Std = 20 lower than front height)

- XY125 Footrest length

**i**  mm (Std = 100mm) (160mm and over requires heavy duty upgrade XB150)

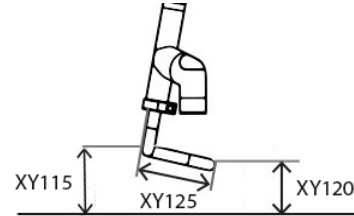

### Footrest Style (Choose One)

- XB010 Tubular aluminium footrest (Height adjustable)

- XB030 Flip up plastic footrest \$352.00 (Angle/height adjustable, with closed frame only)

- XB070 Angle adjustable aluminium footrest \$207.00 (Angle/height adjustable)

- XB150 Heavy duty tubular footrest \$180.00 (Height adjustable, for Freewheel use)

- TGAXB080 Tubular footrest welded into frame \$101.00 (No height adjustment)

### Footrest Cover

- XB050 Carbon fibre cover \$248.00 (Not with XB070 & XB030)

- XB170 Aluminium cover \$98.00 (Not with XB070 & XB030)

- XB040 Plastic Cover \$98.00 (Not with XB070 & XB030)

- XB165 Rubber grip tape \$86.00 (3M Safety walk)(not with XB030)

CASTER WHEELS, FORKS & WHEEL LOCKS	
Caster Wheels	
75mm (3")	
<input type="checkbox"/> XC150 Aluminium centre 3"x1.4" \$232.00 (Silver hub and black urethane tire)	
100mm (4")	
<input type="checkbox"/> XC060 Soft roll 4"x1.3" (Black)	
<input type="checkbox"/> XC110 Aluminium centre 4"x1" \$232.00 (Silver hub and black urethane tire)	
<input type="checkbox"/> XC130 Aluminium centre 4"x1.4" \$232.00 (choose colour below)	
<input type="checkbox"/> Silver hub & black tire (Std) <input type="checkbox"/> Black hub & blue tire <input type="checkbox"/> Purple hub & black tire <input type="checkbox"/> Silver hub & blue tire	<input type="checkbox"/> Black hub & black tire <input type="checkbox"/> Red hub & black tire <input type="checkbox"/> Gold hub & black tire <input type="checkbox"/> Silver hub & red tire
125mm (5")	
<input type="checkbox"/> XC070 Soft roll 5"x1.3" (Black)	<input type="checkbox"/> XC120 Aluminium centre 5"x1" \$232.00 (Silver hub and black urethane tire)
<input type="checkbox"/> XC100 Pneumatic Aluminium centre 5"x1" \$248.00 (Grey)	<input type="checkbox"/> XC140 Aluminium centre 5"x1.4" \$232.00 (Silver hub and black urethane tire)
150mm (6")	
<input type="checkbox"/> XC080 Soft roll 6"x1.3"	<input type="checkbox"/> XC145 Aluminium centre 6"x1.4" \$310.00 (Silver hub and black urethane tire)
200mm (8")	
<input type="checkbox"/> XC185 Pneumatic offroad 8"x2" \$310.00 (only with TX Forward castor position)	
Caster Forks	
<input type="checkbox"/> XC190 Low ride caster fork (Std when no option selected)	<input type="checkbox"/> XC210 Froglegs suspension caster fork \$633.00
<i>Note: Colour follows accent</i>	<input type="checkbox"/> Black <input type="checkbox"/> Silver
Caster Pin Width	
<input checked="" type="checkbox"/> XY330 Caster pin width <div style="display: flex; align-items: center; margin-top: 5px;"> <div style="border: 1px solid black; width: 100px; height: 20px; display: flex; align-items: center; justify-content: center;"> <span style="font-size: 8px;">mm</span> </div> </div> <div style="margin-top: 5px;"> <input type="checkbox"/> Optimize measurements                 </div>	
Wheel Lock Options (choose one)	
<input type="checkbox"/> XD020 Underseat Scissor	<input type="checkbox"/> XD050 Push to lock
<input type="checkbox"/> XD030 Compact scissor \$266.00	<input type="checkbox"/> XD046 Out Front push to lock \$409.00
<input type="checkbox"/> XD035 Compact scissor with lightweight fixing \$352.00 (Only with fixed centre of gravity)	
<input type="checkbox"/> XD045 Out Front Compact scissor \$409.00	<input type="checkbox"/> XD010 Omit wheel locks

SIDEGUARDS AND ARMRESTS																																																																																													
<table border="1" style="width: 100%; border-collapse: collapse;"> <thead> <tr> <th colspan="2" style="text-align: center; background-color: #eee;">Sideguard Aluminium Options</th> </tr> </thead> <tbody> <tr> <td><input type="checkbox"/> XE030</td> <td>Screw on aluminium \$327.00</td> </tr> <tr> <td><input type="checkbox"/> XE080</td> <td>Lift out aluminium \$532.00</td> </tr> <tr> <td><input type="checkbox"/> TGAXE130</td> <td>Fold flat aluminium \$505.00</td> </tr> <tr> <td><input type="checkbox"/> XE180</td> <td>Flip back aluminium \$393.00</td> </tr> <tr> <td><input type="checkbox"/> TGAXE220</td> <td>Welded with 6mm bead \$354.00</td> </tr> <tr> <td><input type="checkbox"/> TGAXE230</td> <td>Welded aluminium sport <i>(Extra strong)</i> \$540.00</td> </tr> </tbody> </table> <table border="1" style="width: 100%; border-collapse: collapse;"> <thead> <tr> <th colspan="2" style="text-align: center; background-color: #eee;">Carbon Fibre Options</th> </tr> </thead> <tbody> <tr> <td><input type="checkbox"/> XE050</td> <td>Screw on carbon fibre \$726.00</td> </tr> <tr> <td><input type="checkbox"/> XE100</td> <td>Lift out carbon fibre \$766.00</td> </tr> <tr> <td><input type="checkbox"/> TGAXE150</td> <td>Fold flat carbon fibre \$819.00</td> </tr> <tr> <td><input type="checkbox"/> XE200</td> <td>Flip back carbon fibre \$600.00</td> </tr> </tbody> </table> <table border="1" style="width: 100%; border-collapse: collapse;"> <thead> <tr> <th colspan="2" style="text-align: center; background-color: #eee;">ABS Plastic Options</th> </tr> </thead> <tbody> <tr> <td><input type="checkbox"/> XE070</td> <td>Screw on ABS plastic \$167.00</td> </tr> <tr> <td><input type="checkbox"/> XE120</td> <td>Lift out ABS plastic \$487.00</td> </tr> <tr> <td><input type="checkbox"/> TGAXE170</td> <td>Fold flat ABS plastic \$462.00</td> </tr> </tbody> </table> <table border="1" style="width: 100%; border-collapse: collapse;"> <thead> <tr> <th colspan="2" style="text-align: center; background-color: #eee;">Armrest Options</th> </tr> </thead> <tbody> <tr> <td><input type="checkbox"/> XF010</td> <td>Lift out armrest with plastic sideguard <i>(Indicate fixed height)</i> \$592.00</td> </tr> <tr> <td><input type="checkbox"/> XF020</td> <td>Lift out armrest with Aluminium sideguard <i>(Indicate fixed height)</i> \$467.00</td> </tr> </tbody> </table> <p style="text-align: center; margin-top: 10px;"><i>Height (Top of seatrail to top of armrest)</i></p> <div style="display: flex; align-items: center;"> <div style="margin-right: 10px;"> <input type="checkbox"/> </div> <div style="border: 1px solid black; width: 100px; height: 20px; display: flex; align-items: center; justify-content: center;">             mm         </div> </div> <table border="1" style="width: 100%; border-collapse: collapse; margin-top: 10px;"> <thead> <tr> <th colspan="2" style="text-align: center; background-color: #eee;">Sideguard Measurements Optimized measurements</th> </tr> </thead> <tbody> <tr> <td><input type="checkbox"/></td> <td>25mm above tire <i>(Follow tire)</i></td> </tr> <tr> <td><input type="checkbox"/></td> <td>Individual above tire <i>(Follow tire)</i></td> </tr> <tr> <td><input type="checkbox"/> </td> <td><div style="border: 1px solid black; width: 100px; height: 20px; display: flex; align-items: center; justify-content: center;">mm</div></td> </tr> <tr> <td><input type="checkbox"/></td> <td>Level with tire <i>(Follow tire)</i></td> </tr> </tbody> </table> <table border="1" style="width: 100%; border-collapse: collapse; margin-top: 10px;"> <thead> <tr> <th colspan="2" style="text-align: center; background-color: #eee;">Individual measurements</th> </tr> </thead> <tbody> <tr> <td><input type="checkbox"/></td> <td>Sideguard length</td> </tr> <tr> <td><input type="checkbox"/> </td> <td><div style="border: 1px solid black; width: 100px; height: 20px; display: flex; align-items: center; justify-content: center;">mm</div></td> </tr> <tr> <td><input type="checkbox"/></td> <td>Sideguard height</td> </tr> <tr> <td><input type="checkbox"/> </td> <td><div style="border: 1px solid black; width: 100px; height: 20px; display: flex; align-items: center; justify-content: center;">mm</div></td> </tr> </tbody> </table>	Sideguard Aluminium Options		<input type="checkbox"/> XE030	Screw on aluminium \$327.00	<input type="checkbox"/> XE080	Lift out aluminium \$532.00	<input type="checkbox"/> TGAXE130	Fold flat aluminium \$505.00	<input type="checkbox"/> XE180	Flip back aluminium \$393.00	<input type="checkbox"/> TGAXE220	Welded with 6mm bead \$354.00	<input type="checkbox"/> TGAXE230	Welded aluminium sport <i>(Extra strong)</i> \$540.00	Carbon Fibre Options		<input type="checkbox"/> XE050	Screw on carbon fibre \$726.00	<input type="checkbox"/> XE100	Lift out carbon fibre \$766.00	<input type="checkbox"/> TGAXE150	Fold flat carbon fibre \$819.00	<input type="checkbox"/> XE200	Flip back carbon fibre \$600.00	ABS Plastic Options		<input type="checkbox"/> XE070	Screw on ABS plastic \$167.00	<input type="checkbox"/> XE120	Lift out ABS plastic \$487.00	<input type="checkbox"/> TGAXE170	Fold flat ABS plastic \$462.00	Armrest Options		<input type="checkbox"/> XF010	Lift out armrest with plastic sideguard <i>(Indicate fixed height)</i> \$592.00	<input type="checkbox"/> XF020	Lift out armrest with Aluminium sideguard <i>(Indicate fixed height)</i> \$467.00	Sideguard Measurements Optimized measurements		<input type="checkbox"/>	25mm above tire <i>(Follow tire)</i>	<input type="checkbox"/>	Individual above tire <i>(Follow tire)</i>	<input type="checkbox"/>	<div style="border: 1px solid black; width: 100px; height: 20px; display: flex; align-items: center; justify-content: center;">mm</div>	<input type="checkbox"/>	Level with tire <i>(Follow tire)</i>	Individual measurements		<input type="checkbox"/>	Sideguard length	<input type="checkbox"/>	<div style="border: 1px solid black; width: 100px; height: 20px; display: flex; align-items: center; justify-content: center;">mm</div>	<input type="checkbox"/>	Sideguard height	<input type="checkbox"/>	<div style="border: 1px solid black; width: 100px; height: 20px; display: flex; align-items: center; justify-content: center;">mm</div>	<table border="1" style="width: 100%; border-collapse: collapse;"> <thead> <tr> <th colspan="2" style="text-align: center; background-color: #eee;">Sideguard with Fender Aluminium Options</th> </tr> </thead> <tbody> <tr> <td><input type="checkbox"/> XE040</td> <td>Screw on aluminium with fender \$279.00</td> </tr> <tr> <td><input type="checkbox"/> XE090</td> <td>Lift out aluminium with fender \$579.00</td> </tr> <tr> <td><input type="checkbox"/> TGAXE140</td> <td>Fold flat aluminium with fender \$499.00</td> </tr> <tr> <td><input type="checkbox"/> XE190</td> <td>Flip back aluminium with fender \$334.00</td> </tr> </tbody> </table> <table border="1" style="width: 100%; border-collapse: collapse; margin-top: 10px;"> <thead> <tr> <th colspan="2" style="text-align: center; background-color: #eee;">Carbon Fibre Options</th> </tr> </thead> <tbody> <tr> <td><input type="checkbox"/> XE060</td> <td>Screw on carbon fibre with fender \$952.00</td> </tr> <tr> <td><input type="checkbox"/> XE110</td> <td>Lift out carbon fibre with fender \$1,132.00</td> </tr> <tr> <td><input type="checkbox"/> TGAXE160</td> <td>Fold flat carbon fibre with fender \$914.00</td> </tr> <tr> <td><input type="checkbox"/> XE210</td> <td>Flip back carbon fibre with fender \$746.00</td> </tr> </tbody> </table> <table border="1" style="width: 100%; border-collapse: collapse; margin-top: 10px;"> <thead> <tr> <th colspan="2" style="text-align: center; background-color: #eee;">Sideguard Measurements Fender Height</th> </tr> </thead> <tbody> <tr> <td><input type="checkbox"/></td> <td>10mm above tire <i>(Standard)</i></td> </tr> <tr> <td><input type="checkbox"/></td> <td>Individual above tire <i>(Min = 10mm)</i></td> </tr> <tr> <td><input type="checkbox"/> </td> <td><div style="border: 1px solid black; width: 100px; height: 20px; display: flex; align-items: center; justify-content: center;">mm</div></td> </tr> </tbody> </table> <div style="text-align: right; margin-top: 10px;"> </div> <table border="1" style="width: 100%; border-collapse: collapse; margin-top: 10px;"> <thead> <tr> <th colspan="2" style="text-align: center; background-color: #eee;">Fender position</th> </tr> </thead> <tbody> <tr> <td><input type="checkbox"/></td> <td>Centre of tire <i>(Standard if no option selected)</i></td> </tr> <tr> <td><input type="checkbox"/></td> <td>Outside of tire</td> </tr> </tbody> </table> <div style="text-align: right; margin-top: 10px;"> </div>	Sideguard with Fender Aluminium Options		<input type="checkbox"/> XE040	Screw on aluminium with fender \$279.00	<input type="checkbox"/> XE090	Lift out aluminium with fender \$579.00	<input type="checkbox"/> TGAXE140	Fold flat aluminium with fender \$499.00	<input type="checkbox"/> XE190	Flip back aluminium with fender \$334.00	Carbon Fibre Options		<input type="checkbox"/> XE060	Screw on carbon fibre with fender \$952.00	<input type="checkbox"/> XE110	Lift out carbon fibre with fender \$1,132.00	<input type="checkbox"/> TGAXE160	Fold flat carbon fibre with fender \$914.00	<input type="checkbox"/> XE210	Flip back carbon fibre with fender \$746.00	Sideguard Measurements Fender Height		<input type="checkbox"/>	10mm above tire <i>(Standard)</i>	<input type="checkbox"/>	Individual above tire <i>(Min = 10mm)</i>	<input type="checkbox"/>	<div style="border: 1px solid black; width: 100px; height: 20px; display: flex; align-items: center; justify-content: center;">mm</div>	Fender position		<input type="checkbox"/>	Centre of tire <i>(Standard if no option selected)</i>	<input type="checkbox"/>	Outside of tire
Sideguard Aluminium Options																																																																																													
<input type="checkbox"/> XE030	Screw on aluminium \$327.00																																																																																												
<input type="checkbox"/> XE080	Lift out aluminium \$532.00																																																																																												
<input type="checkbox"/> TGAXE130	Fold flat aluminium \$505.00																																																																																												
<input type="checkbox"/> XE180	Flip back aluminium \$393.00																																																																																												
<input type="checkbox"/> TGAXE220	Welded with 6mm bead \$354.00																																																																																												
<input type="checkbox"/> TGAXE230	Welded aluminium sport <i>(Extra strong)</i> \$540.00																																																																																												
Carbon Fibre Options																																																																																													
<input type="checkbox"/> XE050	Screw on carbon fibre \$726.00																																																																																												
<input type="checkbox"/> XE100	Lift out carbon fibre \$766.00																																																																																												
<input type="checkbox"/> TGAXE150	Fold flat carbon fibre \$819.00																																																																																												
<input type="checkbox"/> XE200	Flip back carbon fibre \$600.00																																																																																												
ABS Plastic Options																																																																																													
<input type="checkbox"/> XE070	Screw on ABS plastic \$167.00																																																																																												
<input type="checkbox"/> XE120	Lift out ABS plastic \$487.00																																																																																												
<input type="checkbox"/> TGAXE170	Fold flat ABS plastic \$462.00																																																																																												
Armrest Options																																																																																													
<input type="checkbox"/> XF010	Lift out armrest with plastic sideguard <i>(Indicate fixed height)</i> \$592.00																																																																																												
<input type="checkbox"/> XF020	Lift out armrest with Aluminium sideguard <i>(Indicate fixed height)</i> \$467.00																																																																																												
Sideguard Measurements Optimized measurements																																																																																													
<input type="checkbox"/>	25mm above tire <i>(Follow tire)</i>																																																																																												
<input type="checkbox"/>	Individual above tire <i>(Follow tire)</i>																																																																																												
<input type="checkbox"/>	<div style="border: 1px solid black; width: 100px; height: 20px; display: flex; align-items: center; justify-content: center;">mm</div>																																																																																												
<input type="checkbox"/>	Level with tire <i>(Follow tire)</i>																																																																																												
Individual measurements																																																																																													
<input type="checkbox"/>	Sideguard length																																																																																												
<input type="checkbox"/>	<div style="border: 1px solid black; width: 100px; height: 20px; display: flex; align-items: center; justify-content: center;">mm</div>																																																																																												
<input type="checkbox"/>	Sideguard height																																																																																												
<input type="checkbox"/>	<div style="border: 1px solid black; width: 100px; height: 20px; display: flex; align-items: center; justify-content: center;">mm</div>																																																																																												
Sideguard with Fender Aluminium Options																																																																																													
<input type="checkbox"/> XE040	Screw on aluminium with fender \$279.00																																																																																												
<input type="checkbox"/> XE090	Lift out aluminium with fender \$579.00																																																																																												
<input type="checkbox"/> TGAXE140	Fold flat aluminium with fender \$499.00																																																																																												
<input type="checkbox"/> XE190	Flip back aluminium with fender \$334.00																																																																																												
Carbon Fibre Options																																																																																													
<input type="checkbox"/> XE060	Screw on carbon fibre with fender \$952.00																																																																																												
<input type="checkbox"/> XE110	Lift out carbon fibre with fender \$1,132.00																																																																																												
<input type="checkbox"/> TGAXE160	Fold flat carbon fibre with fender \$914.00																																																																																												
<input type="checkbox"/> XE210	Flip back carbon fibre with fender \$746.00																																																																																												
Sideguard Measurements Fender Height																																																																																													
<input type="checkbox"/>	10mm above tire <i>(Standard)</i>																																																																																												
<input type="checkbox"/>	Individual above tire <i>(Min = 10mm)</i>																																																																																												
<input type="checkbox"/>	<div style="border: 1px solid black; width: 100px; height: 20px; display: flex; align-items: center; justify-content: center;">mm</div>																																																																																												
Fender position																																																																																													
<input type="checkbox"/>	Centre of tire <i>(Standard if no option selected)</i>																																																																																												
<input type="checkbox"/>	Outside of tire																																																																																												

BACKREST	
Backrest Height	
<input type="checkbox"/> XY230 Fixed height backrest Specify height <input style="width: 100px;" type="text"/> mm 	<input type="checkbox"/> XY245 Adjustable height backrest \$248.00 (+/-25mm) Specify height <input style="width: 100px;" type="text"/> mm 
Backrest Design	
<input type="checkbox"/> XG010 Fixed backrest (Non-folding)	<input type="checkbox"/> TGAXG020 Folding backrest \$474.00 (with 2 position snap lock and angle adjust ± 5 Deg)
Ergonomic Options	
<input checked="" type="checkbox"/> XY360 Backrest angle -5   -3   0   +3   +5 Individual <input style="width: 100px;" type="text"/> mm (Max -10/+20 Deg) 	<input type="checkbox"/> XG100 Ergonomic backrest \$146.00 Vertical height <input style="width: 100px;" type="text"/> mm Rearward position <input style="width: 100px;" type="text"/> mm 
<input type="checkbox"/> XG110 Inward taper \$146.00 (inside of backrest posts) Specify width or per side <input style="width: 100px;" type="text"/> mm 	<input type="checkbox"/> XG120 Outward flare \$146.00 (inside of backrest posts) Specify width or per side <input style="width: 100px;" type="text"/> mm 
Push handle Options	
<input type="checkbox"/> XG070 Screw in push handles \$225.00 (N/A with XY245)	<input type="checkbox"/> XG090 Stroller push handles height adjustable \$441.00 Height from floor to top of handles <input style="width: 100px;" type="text"/> mm <input type="checkbox"/> Optimize (1000mm from floor)
<input type="checkbox"/> XG080 Flip down push handles \$441.00 (N/A with XY245)	<input type="checkbox"/> XG097 Integrated push handle \$676.00 (Quickie design)
<input type="checkbox"/> XG085 Flip down push handles height adjustable \$720.00 (N/A with XY245)	
Backrest Options	
<input type="checkbox"/> XG040 Heavy duty backrest upgrade \$207.00 (Recommended for hand cycling) (Not with XY245)	<input type="checkbox"/> XG130 Extra deep Square brace bar \$115.00 (Recommended for JAY backs) (Std - 90mm) Depth <input style="width: 100px;" type="text"/> mm
ILSA Backrest Options	
<input type="checkbox"/> XG140 Integrated lateral support \$479.00 A - Left <input style="width: 100px;" type="text"/> mm A - Right <input style="width: 100px;" type="text"/> mm B - Left <input style="width: 100px;" type="text"/> mm B - Right <input style="width: 100px;" type="text"/> mm C - Left <input style="width: 100px;" type="text"/> mm C - Right <input style="width: 100px;" type="text"/> mm D - Left <input style="width: 100px;" type="text"/> mm D - Right <input style="width: 100px;" type="text"/> mm	

CAMBER BAR	
<p style="text-align: center; background-color: #eee; margin: 0;">Adjustable Centre of Gravity</p> <p><input type="checkbox"/> XH110 Square back adjustable centre of gravity (25-150mm)</p> <div style="display: flex; align-items: center; margin-top: 10px;"> <div style="margin-right: 10px;"> </div> <div style="border: 1px solid black; padding: 2px 10px;">Specify measurement</div> <div style="margin-left: 10px;">mm</div> </div> <div style="text-align: right; margin-top: 10px;"> </div> <p><input type="checkbox"/> XH120 Round back adjustable centre of gravity (60-150mm)</p> <div style="display: flex; align-items: center; margin-top: 10px;"> <div style="margin-right: 10px;"> </div> <div style="border: 1px solid black; padding: 2px 10px;">Specify measurement</div> <div style="margin-left: 10px;">mm</div> </div> <div style="text-align: right; margin-top: 10px;"> </div>	<p style="text-align: center; background-color: #eee; margin: 0;">Fixed Centre of Gravity</p> <p><input type="checkbox"/> TGAXH100 Single post fixed centre of gravity (25-125mm) \$613.00 <i>(Open frame only)</i> <i>(Not with Crash test option)</i></p> <div style="display: flex; align-items: center; margin-top: 10px;"> <div style="margin-right: 10px;"> </div> <div style="border: 1px solid black; padding: 2px 10px;">Specify measurement</div> <div style="margin-left: 10px;">mm</div> </div> <div style="text-align: right; margin-top: 10px;"> </div> <p><input type="checkbox"/> TGAXH090 V-style fixed centre of gravity (25-125mm) \$613.00</p> <div style="display: flex; align-items: center; margin-top: 10px;"> <div style="margin-right: 10px;"> </div> <div style="border: 1px solid black; padding: 2px 10px;">Specify measurement</div> <div style="margin-left: 10px;">mm</div> </div> <div style="text-align: right; margin-top: 10px;"> </div>
<p style="text-align: center; background-color: #eee; margin: 0;">Specify Camber Angle</p> <p><input checked="" type="checkbox"/> XY390 Camber angle</p> <div style="display: flex; align-items: center; margin-top: 10px;"> <div style="margin-right: 10px;"> </div> <div style="display: flex; gap: 5px;"> <input type="checkbox"/> 0                     <input type="checkbox"/> 1                     <input type="checkbox"/> 2                     <input type="checkbox"/> 3                     <input type="checkbox"/> 5                 </div> </div>	<p style="text-align: center; background-color: #eee; margin: 0;">Specify Camber Angle</p> <p><input checked="" type="checkbox"/> XY390 Camber angle</p> <div style="display: flex; align-items: center; margin-top: 10px;"> <div style="margin-right: 10px;"> </div> <div style="display: flex; gap: 5px;"> <input type="checkbox"/> 0                     <input type="checkbox"/> 1                     <input type="checkbox"/> 2                     <input type="checkbox"/> 3                     <input type="checkbox"/> 5                 </div> </div>
<p style="text-align: center; background-color: #eee; margin: 0;">Camber Bar Options</p> <p><input type="checkbox"/> XH040 Handbike camber bar fixed \$400.00</p> <div style="margin-top: 10px;"> <p> Camber angle (Handbike camber bar)</p> <div style="display: flex; gap: 10px;"> <input type="checkbox"/> 0                     <input type="checkbox"/> 5                 </div> </div> <div style="margin-top: 10px;"> <p> Caster height from floor for handbike fitting (Standard 30mm if not indicated)</p> <div style="display: flex; gap: 10px;"> <input type="checkbox"/> 30                     <input type="checkbox"/> 50                 </div> </div> <p><input type="checkbox"/> XH030 Froglegs suspension camber bar \$854.00</p>	<p style="text-align: center; background-color: #eee; margin: 0;">Camber Bar Options</p> <p><input type="checkbox"/> XH040 Handbike camber bar fixed \$400.00</p> <div style="margin-top: 10px;"> <p> Camber angle (Handbike camber bar)</p> <div style="display: flex; gap: 10px;"> <input type="checkbox"/> 0                     <input type="checkbox"/> 5                 </div> </div> <div style="margin-top: 10px;"> <p> Caster height from floor for handbike fitting (Standard 30mm if not indicated)</p> <div style="display: flex; gap: 10px;"> <input type="checkbox"/> 30                     <input type="checkbox"/> 50                 </div> </div>
Anti-Tip Options	
<p><input type="checkbox"/> XJ010 Swingaway anti tip LEFT side (Only with square back frame. Not with XH040) \$167.00</p> <p><input type="checkbox"/> XJ020 Swingaway anti tip RIGHT side (Only with square back frame. Not with XH040) \$167.00</p>	<p><input type="checkbox"/> XJ100 Single sport anti tip (centre mounted) \$504.00</p>

REAR WHEELS	
Rear Wheel Size	
<input type="checkbox"/> XY420 24" Wheels	<input type="checkbox"/> XY430 25" Wheels
Rear Wheel Gap	
<div style="display: flex; align-items: center;"> <div style="margin-right: 20px;"> <input checked="" type="checkbox"/> XY460 Rear wheel gap   15 <input type="checkbox"/> 20 <input type="checkbox"/> 25                  Individual <input style="width: 100px; height: 20px;" type="text"/> mm             </div> <div style="margin-left: 20px;"> </div> </div>	
Rear Wheel Options	
<input type="checkbox"/> XK010 Fusion 16 spoke <i>(Silver Hub, black spokes)</i> <input type="checkbox"/> XK050 Spinerger LX 12 spoke \$1000.00 <input type="checkbox"/> XK150 Spinerger CLX 18 carbon blade spoke \$3,139.00 <b>Spinerger Colour Options:</b>	<input type="checkbox"/> XK320 Spinerger XLX 12 spoke, cross/radial spoked \$1,067.00 <input type="checkbox"/> XK060 Spinerger SPOX 18 spoke \$665.00 <input type="checkbox"/> XK070 Spinerger BLXL 18 blade spoke \$1,067.00 <i>(N/A in silver hub)</i>
<input type="checkbox"/> Black spokes <input type="checkbox"/> White spokes <input type="checkbox"/> Yellow spokes <input type="checkbox"/> Red spokes <input type="checkbox"/> Blue spokes <input type="checkbox"/> Pink spokes <input type="checkbox"/> Purple spokes <input type="checkbox"/> Orange spokes <input type="checkbox"/> Green spokes	<input type="checkbox"/> XK180 Individual spoke design \$213.00 Inside: _____ Outside: _____
<b>Spinerger Anodise Options</b>	
<input type="checkbox"/> XK190 Black hub <i>(std option)</i> <input type="checkbox"/> XK202 Purple hub/rims <i>(LX, XLX &amp; BLXL only)</i>	<input type="checkbox"/> XK200 Silver hub \$127.00 <i>(n/a with BLXL/CLX)</i> <input type="checkbox"/> XK203 Blue hub/rims \$409.00 <i>(LX, XLX &amp; BLXL only)</i>
<input type="checkbox"/> XK201 Red hub/rims \$409.00 <i>(LX, XLX &amp; BLXL only)</i> <input type="checkbox"/> XK204 Gold hub/rims \$539.00 <i>(LX, XLX &amp; BLXL only)</i>	<input type="checkbox"/> XK205 Individual hub/rims \$568.00 Select colour: _____
Supply Without Wheels	
<input type="checkbox"/> XK040 Supply without Wheels	<div style="display: flex; justify-content: space-between; margin-top: 5px;"> <div style="border: 1px solid black; padding: 2px;">Wheel Type:</div> <div style="border: 1px solid black; padding: 2px;">Tire Type:</div> </div>
Handrim Position / Options	
<input type="checkbox"/> XY480 Narrow set handrim <input type="checkbox"/> XL090 Remove excess mounting tabs \$146.00 <i>(recommended for small wheel gaps)</i>	<input type="checkbox"/> XY485 Wide set handrim
Handrim Styles	
<input type="checkbox"/> XL010 Aluminium hard anodised 6 tab <i>(Standard if no option selected)</i> <input type="checkbox"/> XL020 Tetra grip 6 tab \$400.00 <input type="checkbox"/> XL100 Para grip 6 tab \$400.00	<input type="checkbox"/> XL040 Titanium 6 tab \$446.00 <input type="checkbox"/> XL050 Stainless steel 6 tab \$243.00
Tire Options	
<input type="checkbox"/> XM010 Kenda \$28.00 <input type="checkbox"/> XM130 Kenda black \$28.00 <input type="checkbox"/> XM020 Schwalbe Marathon Plus \$98.00 <input type="checkbox"/> XM040 Shox solid airless (Black) \$160.00	<input type="checkbox"/> Grey <input type="checkbox"/> Blue <input type="checkbox"/> Red <input type="checkbox"/> XM060 Schwalbe One (24",25" only) \$133.00 <input type="checkbox"/> XM050 Kenda K885 mountain bike tire (24",25" only) \$40.00
Inner Tube Valve Options	
<input type="checkbox"/> XY500 Schraeder inner tube valve <i>(Standard if no option selected)</i>	<input type="checkbox"/> XY490 Presta inner tube valve
Wheel Accessories	
<input type="checkbox"/> XK310 Offroad wheel set 24" rim with handrim, MTB tire and axle pins (Replaces 25" wheel with XM010) \$933.00	<input type="checkbox"/> XK300 Offroad wheel set 22" rim with handrim, MTB tire and axle pins (Replaces 24" wheel with XM010) \$933.00



FINISH OPTIONS							
Frame & Component Finish							
<input type="checkbox"/> XN010 Powder coated frame		<input type="checkbox"/> XN150 Powder coated components <i>(Frame colour if not specified)</i>					
<i>Frame</i>	<i>Comp.</i>	<i>Gloss</i>	<i>Frame Comp.</i>	<i>Matt</i>	<i>Frame Comp.</i>	<i>Special</i>	
<input type="checkbox"/>	<input type="checkbox"/>	<input type="checkbox"/> Black gloss 103	<input type="checkbox"/>	<input type="checkbox"/> Black matt 105	<input type="checkbox"/>	<input type="checkbox"/> Chrome Mirror 300	
<input type="checkbox"/>	<input type="checkbox"/>	<input type="checkbox"/> White gloss 100	<input type="checkbox"/>	<input type="checkbox"/> White matt 101	<input type="checkbox"/>	<input type="checkbox"/> Sparkle silver 170	
<input type="checkbox"/>	<input type="checkbox"/>	<input type="checkbox"/> Grey gloss 132	<input type="checkbox"/>	<input type="checkbox"/> Grey matt 131	<input type="checkbox"/>	<input type="checkbox"/> Metallic black matt 104	
<input type="checkbox"/>	<input type="checkbox"/>	<input type="checkbox"/> Cream gloss 135	<input type="checkbox"/>	<input type="checkbox"/> Light grey matt 133	<input type="checkbox"/>	<input type="checkbox"/> Metallic grey matt 130	
<input type="checkbox"/>	<input type="checkbox"/>	<input type="checkbox"/> Red gloss 108	<input type="checkbox"/>	<input type="checkbox"/> Navy blue matt 152	<input type="checkbox"/>	<input type="checkbox"/> Black sandpaper 201	
<input type="checkbox"/>	<input type="checkbox"/>	<input type="checkbox"/> Yellow gloss 120			<input type="checkbox"/>	<input type="checkbox"/> Grey sandpaper 202	
<input type="checkbox"/>	<input type="checkbox"/>	<input type="checkbox"/> Forest green gloss 143			<input type="checkbox"/>	<input type="checkbox"/> White sandpaper 200	
<input type="checkbox"/>	<input type="checkbox"/>	<input type="checkbox"/> Green gloss 107					
<input type="checkbox"/>	<input type="checkbox"/>	<input type="checkbox"/> Dark blue gloss 151					
<input type="checkbox"/>	<input type="checkbox"/>	<input type="checkbox"/> Royal blue gloss 154					
<input type="checkbox"/>	<input type="checkbox"/>	<input type="checkbox"/> Blue gloss 174					
<input type="checkbox"/>	<input type="checkbox"/>	<input type="checkbox"/> Duckegg blue gloss 141					
<input type="checkbox"/>	<input type="checkbox"/>	<input type="checkbox"/> Pink gloss 188					
<input type="checkbox"/>	<input type="checkbox"/>	<input type="checkbox"/> Orange gloss 180					
<input type="checkbox"/>	<input type="checkbox"/>	<input type="checkbox"/> Purple gloss 157					
<input type="checkbox"/>	TGAXN030	Brushed frame \$565.00 <i>(All parts black unless XN160 chosen)</i>	<input type="checkbox"/>	XN160	Brushed components \$121.00		
<input type="checkbox"/>	TGAXN050	Polished frame \$1,311.00 <i>(All parts black unless XN170 chosen)</i>	<input type="checkbox"/>	XN170	Polished components \$213.00		
Accent Colour							
<b>Note:</b> Accent colour includes, forks, clamps & castor caps.							
	<input type="checkbox"/>	Black accent	<input type="checkbox"/>	Silver accent	<input type="checkbox"/>	RGK-XN250 Individual Accent Colour \$315.00	
	<input type="checkbox"/>	Red accent	<input type="checkbox"/>	Blue accent			
	<input type="checkbox"/>	Purple accent	<input type="checkbox"/>	Carbon accent <i>(Castor caps only, black for rest)</i>			
UPHOLSTERY							
Seat Upholstery							
<input type="checkbox"/>	XP040	Seat sling adjustable tension with straps	<input type="checkbox"/>	XR050	Carbon fibre seat plate \$480.00		
Backrest Upholstery							
<input type="checkbox"/>	XP050	Airtech backrest strap adjustable	<input type="checkbox"/>	XP070	Backrest upgrade to leather corners (Black) \$121.00		
Backrest Stitching Options							
<input type="checkbox"/>	Silver	<input type="checkbox"/>	Black	<input type="checkbox"/>	Blue	<input type="checkbox"/>	Individual:
<input type="checkbox"/>	Red	<input type="checkbox"/>	Light blue	<input type="checkbox"/>	Purple		
Backrest RGK Logo Colour							
<input type="checkbox"/>	White (Std)	<input type="checkbox"/>	Green	<input type="checkbox"/>	Blue	<input type="checkbox"/>	Individual:
<input type="checkbox"/>	Red	<input type="checkbox"/>	Light blue	<input type="checkbox"/>	Purple		
Backrest Accessories							
<input type="checkbox"/>	XP110	Backrest with zip pocket \$127.00	<input type="checkbox"/>	XP170	Individual backrest embroidery \$240.00 <i>(Provide .jpeg file and positioning)</i>		

<b>CUSHION</b>	
Cushion foam options	
<input type="checkbox"/> XP080 \$121.00	Cushion foam <i>(select density and size below)</i>
<input type="checkbox"/> Soft (CMS040)  <input type="checkbox"/> 50mm	<input type="checkbox"/> Medium (CMS050)  <input type="checkbox"/> 75mm
<input type="checkbox"/> Hard (9lb recon)  <input type="checkbox"/> 100mm	
Cushion Cover Upgrades	
<input type="checkbox"/> XP081 \$98.00	Nylon cushion cover <i>(Black)</i>
<input type="checkbox"/> XP090 \$98.00	Air Lite cushion cover <i>(Black)</i>
<input type="checkbox"/> XP100 \$254.00	Leather cushion cover <i>(Black)</i>
Jay Products	
<input type="checkbox"/> JAY Cushion <i>(Price dependant on size / option)</i>	<input type="checkbox"/> Jay Order form attached
<input type="checkbox"/> JAY Backrest <i>(Price dependant on size / option)</i>	<input type="checkbox"/> Jay Order form attached
<input type="checkbox"/> JAY Whitmyer Headrest <i>(Price dependant on size / option)</i>	<input type="checkbox"/> Jay Order form attached
Notes: <div style="border: 1px solid black; width: 200px; height: 80px; display: inline-block;"></div>	
FRAME OPTIONS	
<input type="checkbox"/> XR060 \$154.00	Welded calf strap mounting loops <i>(To locate calf strap on front frame)</i>
Specify height from floor <input style="width: 100px; height: 20px;" type="text"/>	
<input type="checkbox"/> Optimize measurements	
ACCESSORIES	
<input type="checkbox"/> XR080 \$1,053.00	Frontwheel assembly <i>(Only with Tubular style footrest)</i>
<input type="checkbox"/> XP120 \$84.00	Frame protectors Neoprene zip fasten with TIGA logo <i>(Black)</i>
<input type="checkbox"/> XP420 \$81.00	Frame protectors Nylon velcro fasten <i>(Black)</i>
<input type="checkbox"/> XR010 \$59.00	Seat pouch velcro attach <i>(Black)</i>
<input type="checkbox"/> XR200 \$151.00	Rucksack with RGK logo (Black)
<input type="checkbox"/> XR020 \$127.00	Underseat large storage bag <i>(Black)</i>
<input checked="" type="checkbox"/> XA020	Tool kit
<input checked="" type="checkbox"/> XS060	Calf strap

**NOTES**
