

Mark For: _____
 Date: _____
 Dealer Acct #: _____
 Dealer: _____
 Dealer Contact: _____
 Dealer Address: _____
 Dealer City: _____ Prov: _____ PC: _____
 Dealer Phone: () _____ Fax: () _____
 Confirmation Email: _____
 Confirm Via: Fax Email

Submitting for: Quote Order
 PO#: _____
ADDITIONAL SHIPPING INFORMATION
 Ship To: _____
 Attention: _____
 Address: _____
 Address: _____
 Ship To City: _____ Prov: _____ PC: _____
 Ship To Phone: () _____ Fax () _____

JAY® J3 Plus Posterior (PA) Backrest



BACKREST WIDTH	22"	24"	26"
BACKCANE WIDTHS	22"-24"	24"-26"	26"-28"
MAX. USER TRUNK WIDTH	21"	23"	25"

Back Height	Mid Thoracic (MT)		22"		24"		26"	
	Width	Options	22"	24"	22"	24"	26"	28"
Mid Thoracic (MT)	12.0" (S)	J3PAMTSxxFS	<input type="checkbox"/> 22 \$1,795	<input type="checkbox"/> 24 \$1,795	<input type="checkbox"/> 26 \$1,795	<input type="checkbox"/> 28 \$1,795		
		J3PAMTSxxTH	<input type="checkbox"/> 22 \$1,795	<input type="checkbox"/> 24 \$1,795	<input type="checkbox"/> 26 \$1,795	<input type="checkbox"/> 28 \$1,795		
	13.5" (M)							
Mid Thoracic (MT) w/ Vanity Shell Extension	20.0" (S)	J3PLUSPASxxFS	<input type="checkbox"/> 22 \$1,918	<input type="checkbox"/> 24 \$1,918	<input type="checkbox"/> 26 \$1,918	<input type="checkbox"/> 28 \$1,918		
		J3PLUSPASxxTH	<input type="checkbox"/> 22 \$1,918	<input type="checkbox"/> 24 \$1,918	<input type="checkbox"/> 26 \$1,918	<input type="checkbox"/> 28 \$1,918		
	21.5" (M)							
	23.0" (T)	J3PLUSPATxxFS	<input type="checkbox"/> 22 \$1,918	<input type="checkbox"/> 24 \$1,918	<input type="checkbox"/> 26 \$1,918	<input type="checkbox"/> 28 \$1,918		
		J3PLUSPATxxTH	<input type="checkbox"/> 22 \$1,918	<input type="checkbox"/> 24 \$1,918	<input type="checkbox"/> 26 \$1,918	<input type="checkbox"/> 28 \$1,918		
Upper Thoracic (UT)	16.5" (S)							
	18.0" (M)	J3PAUTMxxFS	<input type="checkbox"/> 22 \$1,912	<input type="checkbox"/> 24 \$1,912				
		J3PAUTMxxTH	<input type="checkbox"/> 22 \$1,912	<input type="checkbox"/> 24 \$1,912				
	19.5" (T)							
Shoulder Height (SH)	21.0" (S)	J3PASHSxxFS	<input type="checkbox"/> 22 \$2,081					
		J3PASHSxxTH	<input type="checkbox"/> 22 \$2,081					
	22.5" (M)							
	24.0" (T)							

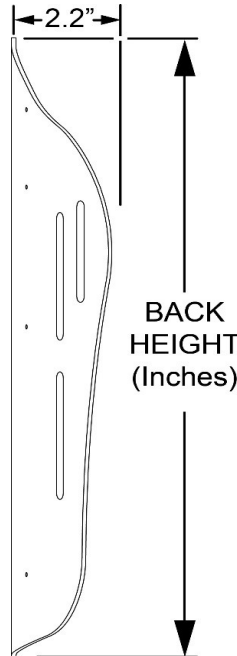

TH

FS

Vanity Shell Extension

MOUNTING HARDWARE OPTIONS

SHELL OPTIONS

Note: Back shells will measure 1" to 4" shorter as the material has been removed to accommodate additional tissue. (MT std -1", MT tall -2", UT med -3", SH std -4") however foam and cover will measure stated back height.

Note: Vanity Shell Extension extends the lower edge of the Mid Thoracic back shell by 8". The shell extension is equipped with dynamic hinges to allow the shell extension to easily move out of the way to discreetly cover the person sitting in the chair.

JAY® J3 Back Accessories

All JAY J3 Plus Back accessories are optional. All accessories will be factory mounted as much as possible to insure proper shipping (If selected below).

SHIPPING INSTRUCTIONS

	Option #	Definition	Price		Option #	Definition	Price
<input checked="" type="checkbox"/>	N/A	Ship Back on Chair (Chair to be ordered separately)	NC	<input checked="" type="checkbox"/>	N/A	Ship accessories mounted on back	NC

Headrests

Use this section for selecting headrest. Head supports are not available on Mid Thoracic Back Shells

STEP 1

Select your HEADREST POST

Please select one box from the below **Headrest Mount & Bracket** choices.

<input type="checkbox"/>	J3HEDX	Axys Mount & Bracket	\$190.00
<input type="checkbox"/>	J3HEDL	LINX Mount & Bracket	\$147.00
<input type="checkbox"/>	J3HEDL2	LINX ² Mount & Bracket	\$349.00

<input type="checkbox"/>	J3HEDO	ONYX Mount & Bracket	\$158.00
<input type="checkbox"/>	J3HEDC	Cobra Mount & Bracket	\$359.00
<input type="checkbox"/>	J3HEDF	Cobra Flip Back Mount and Bracket	\$422.00



STEP 2

Select your HEADREST PAD

Please select one box from the below **Headrest Pad** choices.

<input type="checkbox"/>	14	J3PLSH14 - 14" Plush Pad	\$207.00
<input type="checkbox"/>	10	J3PLSH10 - 10" Plush Pad	\$207.00
<input type="checkbox"/>	8	J3PLSH8 - 8" Plush Pad	\$207.00
<input type="checkbox"/>	HUPL	J3HUPL - HeadsUp Lrg: 5.3" Lng Arms	\$353.00
<input type="checkbox"/>	HUPM	J3HUPM - HeadsUp Med: 4.1" Sht Arms	\$353.00
<input type="checkbox"/>	HUPS	J3HUPS - HeadsUp Sml: 3.5" Sht Arms	\$353.00

<input type="checkbox"/>	AAPS	J3AAPS - Adjust-A-Plush Standard (Lg)	\$353.00
<input type="checkbox"/>	AAPM	J3AAPM - Adjust-A-Plush Medium	\$353.00
<input type="checkbox"/>	AAPN	J3AAPN - Adjust-A-Plush Narrow (Sm)	\$353.00
<input type="checkbox"/>	CL	J3CRDLLG - Lrg Contour Cradle Pad	\$401.00
<input type="checkbox"/>	CM	J3CRDLMD - Med Contour Cradle Pad	\$401.00
<input type="checkbox"/>	PL	J3CPLULG - Large C-Plush Pad	\$401.00
<input type="checkbox"/>	PM	J3CPLUMD - Medium C-Plush Pad	\$401.00

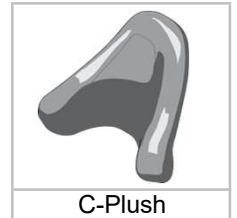
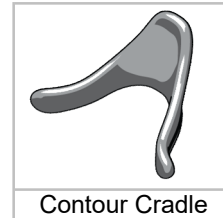
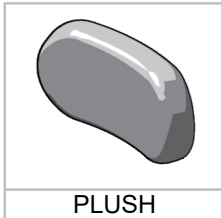

Universal Mounting Plate

<input type="checkbox"/>	J3UHM	Universal Headrest Mounting Plate Only	\$67.00
--------------------------	-------	--	---------

Lateral Supports

Use this section for selecting laterals and hardware. Lateral supports are not available on Mid Thoracic Back Shells

Lateral Thoracic Support (Fixed)

Includes fixed mounting hardware. Lateral pads use 3DX covers with 1/2" Sunmate foam in the core

<input type="checkbox"/>	J3LAT4X4FX	LATERAL 4" Depth X 4" Height FIXED	\$330.00	<input type="checkbox"/>	J3LAT6X4FX	LATERAL 6" Depth X 4" Height FIXED	\$330.00
<input type="checkbox"/>	J3LAT4X5FX	LATERAL 4" Depth X 5" Height FIXED	\$330.00	<input type="checkbox"/>	J3LAT6X5FX	LATERAL 6" Depth X 5" Height FIXED	\$330.00
<input type="checkbox"/>	J3LAT4X6FX	LATERAL 4" Depth X 6" Height FIXED	\$330.00	<input type="checkbox"/>	J3LAT6X6FX	LATERAL 6" Depth X 6" Height FIXED	\$330.00

Swing-Away Lateral Thoracic Support

Includes: Swing-away mounting hardware, left and right lateral are independent. Different types and sizes can be selected for each side.

Left Side				Right Side			
<input type="checkbox"/>	JLATSA44L	LAT 4X4 W/ S/A MOUNTS - LH	\$329.00	<input type="checkbox"/>	JLATSA44R	LAT 4X4 W/ S/A MOUNTS - RH	\$329.00
	J3HEDX	Lateral 4" Depth X 4" Height	\$212.00		JLAT4X4	Lateral 4" Depth X 4" Height	\$212.00
	JSAMNTL	Lateral Swing Away Mount - Left	\$117.00		JSAMNTR	Lateral Swing Away Mount - Right	\$117.00
<input type="checkbox"/>	JLATSA45L	LAT 4X5 W/ S/A MOUNTS - LH	\$329.00	<input type="checkbox"/>	JLATSA45R	LAT 4X5 W/ S/A MOUNTS - RH	\$329.00
	JLAT4X5	LATERAL 4" Depth X 5" Height	\$212.00		JLAT4X5	Lateral 4" Depth X 5" Height	\$212.00
	JSAMNTL	Lateral Swing Away Mount - Left	\$117.00		JSAMNTR	Lateral Swing Away Mount - Right	\$117.00
<input type="checkbox"/>	JLATSA46L	LAT 4X6 W/ S/A MOUNTS - LH	\$329.00	<input type="checkbox"/>	JLATSA46R	LAT 4X6 W/ S/A MOUNTS - RH	\$329.00
	JLAT4X6	LATERAL 4" Depth X 6" Height	\$212.00		JLAT4X6	Lateral 4" Depth X 6" Height	\$212.00
	JSAMNTL	Lateral Swing Away Mount - Left	\$117.00		JSAMNTR	Lateral Swing Away Mount - Right	\$117.00
<input type="checkbox"/>	JLATSA64L	LAT 6X4 W/ S/A MOUNTS - LH	\$329.00	<input type="checkbox"/>	JLATSA64R	LAT 6X4 W/ S/A MOUNTS - RH	\$329.00
	JLAT6X4	LATERAL 6" Depth X 4" Height	\$212.00		JLAT6X4	Lateral 6" Depth X 4" Height	\$212.00
	JSAMNTL	Lateral Swing Away Mount - Left	\$117.00		JSAMNTR	Lateral Swing Away Mount - Right	\$117.00
<input type="checkbox"/>	JLATSA65L	LAT 6X5 W/ S/A MOUNTS - LH	\$329.00	<input type="checkbox"/>	JLATSA65R	LAT 6X5 W/ S/A MOUNTS - RH	\$329.00
	JLAT6X5	LATERAL 6" Depth X 5" Height	\$212.00		JLAT6X5	Lateral 6" Depth X 5" Height	\$212.00
	JSAMNTL	Lateral Swing Away Mount - Left	\$117.00		JSAMNTR	Lateral Swing Away Mount - Right	\$117.00
<input type="checkbox"/>	JLATSA66L	LAT 6X6 W/ S/A MOUNTS - LH	\$329.00	<input type="checkbox"/>	JLATSA66R	LAT 6X6 W/ S/A MOUNTS - RH	\$329.00
	JLAT6X6	J3PLSH14 - 14" Plush Pad	\$212.00		JLAT6X6	J3AAPS - Adjust-A-Plush Standard (Lg)	\$212.00
	JSAMNTL	J3PLSH10 - 10" Plush Pad	\$117.00		JSAMNTR	J3AAPM - Adjust-A-Plush Medium	\$117.00



Rotational Swing-Away Lateral Thoracic Support

Includes: Rotational swing-away mounting hardware, left and right lateral are independent. Different types and sizes can be selected for each side.

Left Side				Right Side			
<input type="checkbox"/>	JLATRSA44L	LAT 4X4 W/ S/A MOUNTS - LH	\$350.00	<input type="checkbox"/>	JLATRSA44R	J3CPLUMD - Medium C-Plush Pad	\$350.00
	JLAT4X4	Lateral 4" Depth X 4" Height	\$212.00		JLAT4X4	Lateral 4" Depth X 4" Height	\$212.00
	JRSAMNTL	Lateral Swing Away Mount - Left	\$138.00		JRSAMNTR	Lateral Swing Away Mount - Right	\$138.00
<input type="checkbox"/>	JLATRSA45L	LAT 4X5 W/ S/A MOUNTS - LH	\$350.00	<input type="checkbox"/>	JLATRSA45R	LAT 4X5 W/ S/A MOUNTS - RH	\$350.00
	JLAT4X5	LATERAL 4" Depth X 5" Height	\$212.00		JLAT4X5	Lateral 4" Depth X 5" Height	\$212.00
	JRSAMNTL	Lateral Swing Away Mount - Left	\$138.00		JRSAMNTR	Lateral Swing Away Mount - Right	\$138.00
<input type="checkbox"/>	JLATRSA46L	LAT 4X6 W/ S/A MOUNTS - LH	\$350.00	<input type="checkbox"/>	JLATRSA46R	LAT 4X6 W/ S/A MOUNTS - RH	\$350.00
	JLAT4X6	LATERAL 4" Depth X 6" Height	\$212.00		JLAT4X6	Lateral 4" Depth X 6" Height	\$212.00
	JRSAMNTL	Lateral Swing Away Mount - Left	\$138.00		JRSAMNTR	Lateral Swing Away Mount - Right	\$138.00
<input type="checkbox"/>	JLATRSA64L	LAT 6X4 W/ S/A MOUNTS - LH	\$350.00	<input type="checkbox"/>	JLATRSA64R	LAT 6X4 W/ S/A MOUNTS - RH	\$350.00
	JLAT6X4	LATERAL 6" Depth X 4" Height	\$212.00		JLAT6X4	Lateral 6" Depth X 4" Height	\$212.00
	JRSAMNTL	Lateral Swing Away Mount - Left	\$138.00		JRSAMNTR	Lateral Swing Away Mount - Right	\$138.00
<input type="checkbox"/>	JLATRSA65L	LAT 6X5 W/ S/A MOUNTS - LH	\$350.00	<input type="checkbox"/>	JLATRSA65R	LAT 6X5 W/ S/A MOUNTS - RH	\$350.00
	JLAT6X5	LATERAL 6" Depth X 5" Height	\$212.00		JLAT6X5	Lateral 6" Depth X 5" Height	\$212.00
	J3UHM	Lateral Swing Away Mount - Left	\$138.00		JRSAMNTR	Lateral Swing Away Mount - Right	\$138.00
<input type="checkbox"/>	JLATRSA66L	LAT 6X6 W/ S/A MOUNTS - LH	\$350.00	<input type="checkbox"/>	JLATRSA66R	LAT 6X6 W/ S/A MOUNTS - RH	\$350.00
	JLAT6X6	LATERAL 6" Depth X 6" Height	\$212.00		JLAT6X6	Lateral 6" Depth X 6" Height	\$212.00
	JRSAMNTL	Lateral Swing Away Mount - Left	\$138.00		JRSAMNTR	Lateral Swing Away Mount - Right	\$138.00

Spine-Align Positioning Components

J3 Plus Backs come standard with a small and large lumbar.

SPINE-ALIGN MINI FIT KIT 1

Includes: 3 wedges, 2 lateral shims, and 2 posterior/lateral pelvic positioning pads.

<input type="checkbox"/>	J3SPNK122	SPINE-ALIGN MINI FIT KIT 1 (22"-26")	\$144.00
--------------------------	-----------	--------------------------------------	----------

LARGE LUMBAR PADS (Back Width) (W" x H" x D")

<input type="checkbox"/>	J3SPNLL22	LG LUMBAR (22"-26") (9.5" x 7" x 1.6")	\$60.00
--------------------------	-----------	--	---------

WEDGES (Back Width) (W" x H" x D")

<input type="checkbox"/>	J3SPNWE22	WEDGES (22"-26") (9.5" x 6.5" x 1.6")	\$46.00
--------------------------	-----------	---------------------------------------	---------

SPINE-ALIGN MINI FIT KIT 2

Includes: 5 wedges, 2 lat shims, 2 post/lat pelvic, 1 lg lumbar, 1 flat shim, and 1 curved







<input type="checkbox"/>	J3SPNK222	SPINE-ALIGN MINI FIT KIT 2 (22"-26")	\$213.00
--------------------------	-----------	--------------------------------------	----------

SMALL LUMBAR PADS (Back Width) (W" x H" x D")

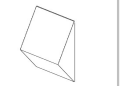
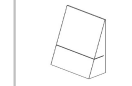
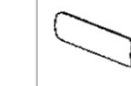
<input type="checkbox"/>	J3SPNSL22	SML LUMBAR (22"-26") (9.5" x 4.3" x 1")	\$62.00
--------------------------	-----------	---	---------

OTHER INDIVIDUAL SPINE-ALIGN COMPONENTS

<input type="checkbox"/>	J3SPNCR	Curved Shim	\$36.00
<input type="checkbox"/>	J3SPNBS	Small Bean Bag	\$41.00
<input type="checkbox"/>	J3SPNFL	Flat Shim	\$36.00
<input type="checkbox"/>	J3SPNBL	Large Bean Bag	\$41.00
<input type="checkbox"/>	J3SPNLS	Lateral Shim	\$66.00
<input type="checkbox"/>	J3SPNLP	Posterior/Lateral Pelvic	\$66.00

									
	Sm Lumbar	Lg Lumbar	Wedge	Curved Slim	Flat	Lateral Slim	Sm Bean Bag	Lg Bean Bag	Post/Lat Pelvic
W	9.5"	9.5"	9.5"	10"	10"	2.4"	6"	10"	5.3"
H	4.3"	7"	6.5"	4"	4"	4.3"	4.5"	3.2"	3.6"
D	1"	1.6"	1.6"	0.5"	0.3"	0.5"	0.75"	0.75"	0.75"

Chest Straps, Harnesses and Brackets

Use this section for selecting harnesses. Harnesses are not available on Mid Thoracic Back Shells

CHEST STRAPS & HARNESSSES (Includes strap guides & mounting hardware)

<input type="checkbox"/>	J3HRNCOL	J3PLSH8 - 8" Plush Pad	\$234.00	<input type="checkbox"/>	J3HRNTDL	J3AAPN - Adjust-A-Plush Narrow (Sm)	\$234.00
<input type="checkbox"/>	J3HRNCOX	J3HUPL - HeadsUp Lrg: 5.3" Lng Arms	\$234.00	<input type="checkbox"/>	J3HRNTDX	J3CRDLLG - Lrg Contour Cradle Pad	\$234.00
<input type="checkbox"/>	J3HRNCDL	J3HUPM - HeadsUp Med: 4.1" Sht Arms	\$234.00	<input type="checkbox"/>	J3HRNTSL	J3CRDLMD - Med Contour Cradle Pad	\$234.00
<input type="checkbox"/>	J3HRNCDX	J3HUPS - HeadsUp Sml: 3.5" Sht Arms	\$234.00	<input type="checkbox"/>	J3HRNTSX	J3CPLULG - Large C-Plush Pad	\$234.00
<input type="checkbox"/>	J3HRNCSL	Classic-Structured Pull Down (Lrg)	\$234.00	<input type="checkbox"/>	J3HRNPSL	J3CPLUMD - Medium C-Plush Pad	\$234.00
<input type="checkbox"/>	J3HRNC SX	Classic-Structured Pull Down (X-Lrg)	\$234.00	<input type="checkbox"/>	J3HRNPSX	Padded Anterior Trunk Straps (X-Lrg)	\$234.00

JRSAMNTL

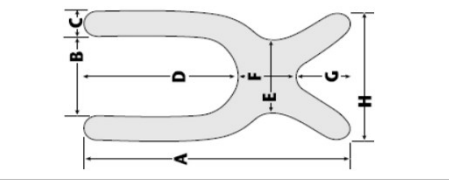

Classic Style

	A	B	C	D	E	F	G	H
L	22.5"	6.5"	2"	13"	6"	6"	3.5"	10.5"
XL	25.5"	6.5"	2.5"	14"	7"	7"	4.5"	11.5"

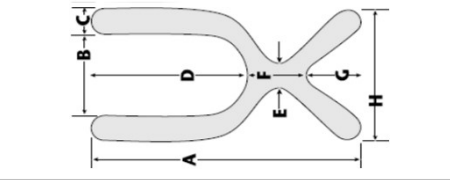

Contour Style

	A	B	C	D	E	F	G	H
L	22.5"	6.5"	2"	13"	1.5"	6"	3.5"	10.5"
XL	25.5"	6.5"	2.5"	14"	1.5"	7"	4.5"	11.5"

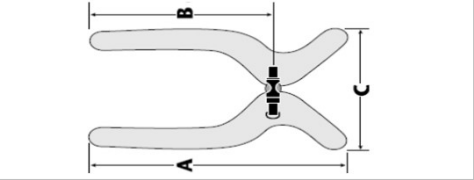

Center-Opening with Buckle

	A	B	C
L	15.5"	11.5"	9.8"
XL	17.5"	12.8"	10"

GUIDE BRACKETS & HARDWARE ONLY

<input type="checkbox"/>	J3GPSG	Shoulder Strap Guides	\$51.00	<input type="checkbox"/>	J3HHP	Hardware Pack Only	\$25
--------------------------	--------	-----------------------	---------	--------------------------	-------	--------------------	------

VANITY FLAP

All J3 Plus Backs ship standard with the vanity flap except J3 Plus Backs with the Vanity Shell Extension

<input type="checkbox"/>	117100	20" to 22" Wide	\$87.00	<input type="checkbox"/>	117102	24" to 26" Wide	\$87.00
<input type="checkbox"/>	117101	22" to 24" Wide	\$87.00	<input type="checkbox"/>	117103	26" to 28" Wide	\$87.00

JAY YOUR WAY MODIFICATIONS

To order sizes offered via JAY Your Way add a "M" to the front of the part number and follow the prompts.

For additional modifications visit www.sunrisemedical.ca

PAINTED BACK SHELL

<input type="checkbox"/>	SBC	Painted Back Shell	NC
	Color:	<input type="checkbox"/> Match Quickie or Zippie Frame Color	

Note: Backshells can be painted any Quickie or Zippie Frame color at no charge please specify the desired color in the NOTES box below. For a full listing of frame colors available please visit www.sunrisemedical.ca

MILITARY SERVICE PATCHES

<input type="checkbox"/>	VAPH	Purple Heart Service Patch	NC
<input type="checkbox"/>	J3HEDX	Marine Service Patch	NC
<input type="checkbox"/>	VAA	Army Service Patch	NC
<input type="checkbox"/>	VAAF	Air Force Service Patch	NC
<input type="checkbox"/>	VAN	Navy Service Patch	NC
<input type="checkbox"/>	VACG	Coast Guard Service Patch	NC

EMBROIDERY

<input type="checkbox"/>	EMBROIDERY	K0108 Embroidery (32 Character Max)	NC
--------------------------	------------	-------------------------------------	----

Location: Front

Font: Block Script

Embroidery Text:

Embroidery Color:

COVER OPTIONS - Contact Surface

<input type="checkbox"/>	DBS	Dartex Back Surface	NC
<input type="checkbox"/>	3DXBS	3DX Back Surface	NC
<input type="checkbox"/>	RDBS	Reverse Dartex Back Surface	NC

COVER OPTIONS - Rear Center Flap

<input type="checkbox"/>	DCC	Digital Camouflage Cover	NC
<input type="checkbox"/>	CBC	Black Cover	NC
<input type="checkbox"/>	CBCI	Black Incontinence Cover	NC

SPINAL FLUID PAD

<input type="checkbox"/>	SFPS	Small Spinal Fluid Pad (16")	\$60.00
<input type="checkbox"/>	SFPM	Medium Spinal Fluid Pad (18")	\$60.00
<input type="checkbox"/>	SFPT	Tall Spinal Fluid Pad (20")	\$60.00
<input type="checkbox"/>	SFPXT	Extra Tall Spinal Fluid Pad (23")	\$60.00

VISCO FOAM INSERT

<input type="checkbox"/>	VF	Visco Foam Insert	NC
<input type="checkbox"/>	VFWSR	Visco Foam Insert with Spinal Relief	\$60.00

Note: 2 Layers of 1" Yellow Visco foam is utilized as standard. Different colors of Visco foam can be utilized just list desired color in notes below.

Don't see the option you want? NO PROBLEM! Write your request below and we can evaluate it and provide a quote.

Notes:



Sunrise Medical Canada Inc

237 Romina Drive, Unit 3 • Concord, ON L4K 4V3 • Canada