

# Quickie Pulse™ 6 Single Power Tilt Seating



July 2018

EIPW22



Account: \_\_\_\_\_  
 Date: \_\_\_\_\_  
 PO#: \_\_\_\_\_  
 Buyer: \_\_\_\_\_  
 Marked For: \_\_\_\_\_

Ship To: \_\_\_\_\_  
 Name: \_\_\_\_\_  
 Address: \_\_\_\_\_  
 City, Province, Postal Code: \_\_\_\_\_  
 Phone: \_\_\_\_\_

✓ Option #	Definition	Price	✓ Option #	Definition	Price
------------	------------	-------	------------	------------	-------

## 1. QUICKIE Pulse™ 6

### QUICKIE Pulse™ 6 SC

<input type="checkbox"/> Quickie Pulse™ 6 SC for Tilt (Fig 1.1)	<b>\$6,680.00</b>
195PC76 Base Package	\$6,680.00

### SC Seating Specifications

<b>HCPC Code</b>				
<b>Typical Chair Weight</b>	<b>W/battery</b>	260 lbs	<b>W/O Battery</b>	182 lbs
<b>Transit</b>	ISO occupied approved			
<b>Seat Type</b>	ASAP II			
<b>Seat size range</b>	<b>Width</b>	12"-22"	<b>Depth</b>	12"-22"
<b>STFH range</b>	<b>ASAP II</b>	17.5" -21.5"		
<b>Power Seating</b>	50° CG tilt			



### Actuators Required by Power Seating Function

<b>50° CG tilt</b>	1 actuator
<b>Power Leg Function (Centermount or Swing away):</b>	2 actuators
<b>Combination : Tilt and Power Elevating Legrest. (Centermount or Swing away):</b>	3 actuators

1.1 Pulse™ SC

### QUICKIE Pulse™ 6 Base Specifications

<b>Drive Wheel Position</b>	Midwheel Drive	<b>Drive Wheels</b>	13" Drive Wheels w/ flat free insert (Black)
<b>User weight Cap</b>	300 lbs.	<b>Tires/Casters</b>	7" Front / 6" rear (Black)
<b>Base size</b>	<b>Width</b> 24" <b>Length</b> 34" <b>Turn Radius</b> 18"	<b>Charger</b>	8A Dual Mode Charger (Compact) CTE
<b>Drive Control</b>	VR-2 90A (non-expand) R-net EL90 (Expandable)	<b>Battery Size</b>	Group 22
<b>Driving Range</b>	Up to 13.5 miles	<b>Shroud Colors</b>	12 standard colors, 6 upgrade prints.
<b>Drive Motors</b>	4-pole 6 mph	<b>Ground Clearance</b>	3"

## 2. BASE CHAIR OPTIONS

Shroud Color			
<input type="checkbox"/>	195EZ01	Candy Apple Red	NC
<input type="checkbox"/>	195EZ02	High Gloss Black	NC
<input type="checkbox"/>	195EZ03	Candy Blue	NC
<input type="checkbox"/>	195EZ04	Silver	NC
<input type="checkbox"/>	195EZ05	Copper	NC
<input type="checkbox"/>	195EZ08	Green Apple	NC
<input type="checkbox"/>	195EZ09	Yellow	NC
<input type="checkbox"/>	195EZ10	Pearl Pink	NC
<input type="checkbox"/>	195EZ11	Candy Purple	NC
<input type="checkbox"/>	195EZ12	Matte Black	NC
<input type="checkbox"/>	195EZ13	Midnight Blue	NC
<input type="checkbox"/>	195EZ15	Pearl White	NC
<input type="checkbox"/>	195EZ06	Digital Camo	\$557.00
<input type="checkbox"/>	195EZ07	Woodland Camo	\$557.00
<input type="checkbox"/>	195EZ14	Carbon Fiber Print	\$557.00
<input type="checkbox"/>	195EZ17	Pink Camo	\$557.00
<input type="checkbox"/>	195EZ18	Grunge Skulls	\$557.00
<input type="checkbox"/>	195EZ16	American Flag	\$557.00

Drive wheel/tire package			
<input type="checkbox"/>	195DW60	Cast Wheel Solid Dual Density Inserts <b>Black</b> Knobby Tires and <b>Black</b> Casters	STD

User weight			
<input type="checkbox"/>	195WG06	< 150 lbs.	NC
<input type="checkbox"/>	195WG13	151-200 lbs.	NC
<input type="checkbox"/>	195WG14	201-250 lbs.	NC
<input type="checkbox"/>	195WG03	251-300 lbs.	NC

Ventilator Options			
<i>Not available w/ Transit, Power Legs</i>			
<input type="checkbox"/>	195VT4	Fixed Vent Tray (Pulmonetic LTV Models)	\$562.00

Motor Package			
<input type="checkbox"/>	195PF88	300 lbs 6 mph 4-Pole	STD

Transit Option			
<input type="checkbox"/>	195TO40	Omit Transit	NC
<input type="checkbox"/>	195TO25	ISO Transit Package for use with ASAP II seating.	NC

Pre-Set Seat Frame Angle			
<input type="checkbox"/>	195FA10	0°	NC
<input type="checkbox"/>	195FA3	3° NA with +3" or +4" STFH	NC

Seat Height			
<i>(Measured in the front) - Obtain Quote to verify est. STFH</i>			
<input type="checkbox"/>	195HT44	Position "0"	NC
<input type="checkbox"/>	195HT45	+1" Seat to Floor Height	NC
<input type="checkbox"/>	195HT46	+2" Seat to Floor Height	NC
<input type="checkbox"/>	195HT47	+3" Seat to Floor Height	NC
<input type="checkbox"/>	195HT48	+4" Seat to Floor Height	NC

STFH Matrix					
Seating Type and Power Option Combinations	Seat-to-Floor Height at 0 tilt				
	Low	+1"	+2"	+3"	+4"
SC ASAP II Tilt only	17.6"	18.6"	19.6"	20.6"	21.6"
STFH measured with batteries but no user. Actual STFH may vary by .5" *Adding seat angle will increase STFH by 1" for each incremental change. **Ultra low STFH may cause ground clearance of Power Centermount to drop below 2".					

## 3. BATTERIES and CHARGERS

Batteries			
<input type="checkbox"/>	195AG21	GP22 Flat Top Batteries Pair w/strap	\$626.00
<input type="checkbox"/>	195AG05	Omit batteries (Includes harness)	NC

Battery Charger			
<input type="checkbox"/>	195BJ19	8A Dual Mode Charger (Compact) CTE	NC

## 4. ELECTRONICS

Drive Control Options			
Non-Expandable Controllers			
<input type="checkbox"/>	195ER01	Non-expandable VR2-90 controller (For Use with 1 Thru-drive seat Function)	NC
<input type="checkbox"/>	195ER09	Non-expandable R-net controller (For use of Tilt and PowerCentermount)	NC

VR2 Joystick			
<input type="checkbox"/>	195J94	Non Expandable VR2 Joystick	NC

Expandable Controllers			
<input type="checkbox"/>	195ER02	R-net Expandable Drive Control Upgrade (90A)	NC
<input type="checkbox"/>	195EX01	Expandable Controller - R-net	\$562.00
<input type="checkbox"/>	195EX02	Harnessing for Expandable Controller	NC

R-net Joystick			
<input type="checkbox"/>	195J70	STD LED Joystick for R-net Ctrl's	NC
<input type="checkbox"/>	195J108	CJSM1: Joystick Standard: w/Stereo Jacks & Color Display	\$168.00
<input type="checkbox"/>	195J114	CJSM2: Joystick Advanced: 3.5" Color Display, Paddle Switches, Shortcut Keys, IR, BT, and Stereo Jack.	\$1,202.00
<input type="checkbox"/>	195J95	Omit JS. For use with OMNI	NC

Joystick Mount (Fixed, Swing Away, Retractable, Mid)			
<input type="checkbox"/>	195JM10	Fixed Mount	NC
<input type="checkbox"/>	195JM11	Swing Away Mount	\$412.00
<input type="checkbox"/>	195JM15	Retractable Joystick mount w/45° stops	\$765.00
<input type="checkbox"/>	195JM14	Mid Line Mount	\$412.00

Joystick Mount (Location)			
<i>Height Adjustable.</i>			
<input type="checkbox"/>	195HM1	Right Side Mount	NC
<input type="checkbox"/>	195HM2	Left Side Mount	NC

Joystick Handle (Optional)			
<input type="checkbox"/>	195JH1	Ball Handle	\$101.00
<input type="checkbox"/>	195JH2	Foam Ball Handle	\$101.00
<input type="checkbox"/>	195JH4	T-Handle	\$101.00
<input type="checkbox"/>	195JH6	Goalpost	\$101.00

Attendant Control			
<input type="checkbox"/>	1950A01	Attendant Control for VR-2	\$1,131.00
<input type="checkbox"/>	1950A02	Attendant Control for R-net	\$1,131.00

Attendant Mounting Location			
<input type="checkbox"/>	195DN1	Mounting location: Right Back Cane	NC
<input type="checkbox"/>	195DN2	Mounting Location: Left Back Cane	NC

R-net OMNI and Output Options			
<i>(For expandable controls, choose all that apply)</i>			
<input type="checkbox"/>	195ON1	R-net OMNI Input Control Module and display with built-in Infrared and armrest mount. Choose mount below. (required for Specialty Input Devices.)	\$2,201.00
<input type="checkbox"/>	195ON2	R-net Output Module (ECM)	\$1,131.00

OMNI Mount			
<i>(If used with Joystick must be mounted opposite side)</i>			
<input type="checkbox"/>	195DS04	Swing Away Left Side OMNI Mount	NC
<input type="checkbox"/>	195DS03	Swing Away Right Side OMNI Mount	NC

Switch inputs for R-net Joysticks or OMNI			
<i>Drive or Mode / Profile Control</i>			
<input type="checkbox"/>	195SW22	Stereo to 2 Mono Splitter	\$79.00
<input type="checkbox"/>	195SW1	Buddy Button Switch	\$101.00
<input type="checkbox"/>	195SW4	Micro Light Switch	\$101.00
<input type="checkbox"/>	195SW24	Egg Switch-Black	\$127.00
<input type="checkbox"/>	195SW21	Dual toggle switch and bracket	\$227.00
<input type="checkbox"/>	195SW35	Switch-It Mini 1 button on Mono plug	\$284.00
<input type="checkbox"/>	195SW36	Switch-It Mini 2 button on 2 Mono plugs	\$284.00
<input type="checkbox"/>	195SW37	Switch-It Mini 2 button on 1 Stereo plug	\$284.00
<input type="checkbox"/>	195SW38	Switch-It Mini 4 button on DB9 connector	\$284.00

Single Switch Mount Bracket			
<input type="checkbox"/>	195EM01	Single Switch Mount Bracket	\$262.00

Electronic Programmers			
<input type="checkbox"/>	195PR2	VR-2 Hand Held Programmer	\$562.00
<input type="checkbox"/>	195PR5	R-net PC Programmer with Dongle	\$652.00

## 5. Specialty Driver Control Options

*Requires expandable R-net controls and OMNI unless otherwise noted. Not available with Upholstered backs.*

### 5a. Proportional Control Packages

<b>Head Control Proportional Packages</b>			
□ <b>Switch-It Dual Pro Proportional Head Control with Whitmyer and Facial Pads (Adult)</b>			<b>\$6,939.00</b>
195ID72		Switch-It Dual Pro Head Control w/facial pad (Adult)	\$6,513.00
195IJ09		SA Boom Mount with Egg Switch Control	\$426.00
□ <b>Switch-It Dual Pro Proportional Head Control with Spot Pads Package</b>			<b>\$6,939.00</b>
195ID70		Switch-It Dual Pro Head Control w/Spot pads	\$6,513.00
195IJ09		SA Boom Mount with Egg Switch Control	\$426.00

<b>Hand Control Proportional Joystick Packages</b>			
□ <b>Switch-It Versa-Guide Compact Joystick Midline with Gatlin Package</b>			<b>\$2,513.00</b>
195ID71		Switch-It Versa-Guide Compact Proportional Joystick	\$2,163.00
195IJ07		S/A Gatlin Mount	\$350.00
□ <b>Switch-It Versa-Guide Compact Joystick Midline and prox flex switches with Gatlin Package</b>			<b>\$3,201.00</b>
195ID71		Switch-It Versa-Guide Compact Proportional Joystick	\$2,163.00
195IM08		Dual Flex Proximity Switches (requires no force)	\$688.00
195IJ07		S/A Gatlin Mount	\$350.00
□ <b>Switch-It Micro-Pilot Joystick with SpaceDisc Package</b>			<b>\$4,251.00</b>
195ID62		Micro-Pilot Proportional Joystick	\$3,749.00
195IJ08		S/A SpaceDisc mount	\$502.00
□ <b>Switch-It Micro-Guide Joystick with SpaceDisc Package</b>			<b>\$5,126.00</b>
195ID63		Micro-Guide Proportional Joystick	\$4,624.00
195IJ08		S/A SpaceDisc mount	\$502.00

<b>Chin Control Proportional Joystick Packages</b>			
□ <b>Switch-It Versa-Guide Chin Control Compact Joystick and Egg Switch Package</b>			<b>\$2,857.00</b>
195ID71		Switch-It Versa-Guide Compact Proportional Joystick	\$2,163.00
195IM07		S/A Mount off backrest	\$268.00
195IJ04		SA Boom Mount with egg switch	\$426.00
□ <b>Switch-It Versa-Guide Chin Control Compact Joystick and Proximity Flex Switches Package</b>			<b>\$3,119.00</b>
195ID71		Switch-It Versa-Guide Compact Proportional Joystick	\$2,163.00
195IM08		Dual Flex Proximity Switches (requires no force)	\$688.00
195IM07		S/A Mount off backrest	\$268.00
□ <b>Switch-It Versa-Guide Bib Chin Control Compact Joystick with Proximity Flex switches Package STD 6"</b>			<b>\$3,654.00</b>
195ID71		Switch-It Versa-Guide Compact Proportional Joystick	\$2,163.00
195IM08		Dual Flex Proximity Switches (requires no force)	\$688.00
195IM05		Bib mount Small	\$803.00
□ <b>Switch-It Versa-Guide Bib Chin Control Compact Joystick with Proximity Flex Switches Package Large 8"</b>			<b>\$3,725.00</b>
195ID71		Switch-It Versa-Guide Compact Proportional Joystick	\$2,163.00
195IM08		Dual Flex Proximity Switches (requires no force)	\$688.00
195IM06		Bib mount Large	\$874.00
□ <b>Switch-It Versa-Guide Bib Chin Control Compact Joystick with Egg Switch Package STD 6"</b>			<b>\$3,392.00</b>
195ID71		Switch-It Versa-Guide Compact Proportional Joystick	\$2,163.00
195IM05		Bib mount Small	\$803.00
195IJ04		SA Boom Mount with egg switch	\$426.00
□ <b>Switch-It Versa-Guide Bib Chin Control Compact Joystick with Egg Switch Package Large 8"</b>			<b>\$3,463.00</b>
195ID71		Switch-It Versa-Guide Compact Proportional Joystick	\$2,163.00
195IM06		Bib mount Large	\$874.00
195IJ04		SA Boom Mount with egg switch	\$426.00
□ <b>Switch-It Micro-Pilot Bib Chin Control with Egg Switch Package STD 6"</b>			<b>\$4,978.00</b>
195ID62		Micro-Pilot Proportional Joystick	\$3,749.00
195IM05		Bib mount Small	\$803.00
195IJ04		SA Boom Mount with egg switch	\$426.00
□ <b>Switch-It Micro-Pilot Bib Chin Control with Egg Switch Package Large 8"</b>			<b>\$5,049.00</b>
195ID62		Micro-Pilot Proportional Joystick	\$3,749.00
195IM06		Bib mount Large	\$874.00
195IJ04		SA Boom Mount with egg switch	\$426.00
□ <b>Switch-It Micro-Guide Bib Chin Control with Egg Switch Package STD 6"</b>			<b>\$5,853.00</b>
195ID63		Micro-Guide Proportional Joystick	\$4,624.00
195IM05		Bib mount Small	\$803.00
195IJ04		SA Boom Mount with egg switch	\$426.00
□ <b>Switch-It Micro-Guide Bib Chin Control with Egg Switch Package Large 8"</b>			<b>\$5,924.00</b>
195ID63		Micro-Guide Proportional Joystick	\$4,624.00
195IM06		Bib mount Large	\$874.00
195IJ04		SA Boom Mount with egg switch	\$426.00

**5. Specialty Driver Control Options (cont.)**

**5a. Switch Control**

*Requires Headrest and/or Headrest Mount*

**3 Switch Proximity Head Arrays** *Choose headrest mount below*

<input type="checkbox"/>	<b>Switch-It Head Array Package 3 Switch Curved (Long)</b>		<b>\$5,679.00</b>
	195II13	Switch-It Proximity Head Array Long	\$5,253.00
	195IJ09	SA Boom Mount with Egg Switch Control	\$426.00
<input type="checkbox"/>	<b>Switch-It Head Array Package 3 switch curved (Stubby)</b>		<b>\$6,037.00</b>
	195II14	Switch-It Proximity Head Array Stubby	\$5,611.00
	195IJ09	SA Boom Mount with Egg Switch Control	\$426.00

**5 Switch Proximity Head Array (No Egg Switch Needed)** *Choose "Headrest Mount for Special Controls"*

<input type="checkbox"/>	195II04	Switch-It Head Array 5 switch flat	\$5,679.00
--------------------------	---------	------------------------------------	------------

**Multiple Switches.**

<input type="checkbox"/>	195SW31	Switch-It 3 Naked proximity switches on DB9 connector. (requires OMNI)	\$3,224.00
<input type="checkbox"/>	195SW32	Switch-It 4 Naked proximity switches on DB9 connector. (requires OMNI)	\$3,945.00
<input type="checkbox"/>	195SW33	Switch-It 5 Naked proximity switches on DB9 connector. (requires OMNI)	\$4,398.00
<input type="checkbox"/>	195SW23	4-way toggle switch button DB9 Connector. Includes bracket	\$711.00

**Sip n' Puff Package** *Choose headrest and HR mount below*

<input type="checkbox"/>	<b>Quickie Sip n' Puff System</b>		<b>\$3,100.00</b>
	195ID34	Sip n' Puff Kit	\$2,189.00
	195IH1	Sip n' Puff Tubing and SA Hardware	\$485.00
	195IJ10	S/A Boom Mount with egg switch	\$426.00

**Whitmyer Headrest Mount for Specialty Controls**

<input type="checkbox"/>	195MH12	Axys Mount & Bracket for Specialty Controls	\$328.00
<input type="checkbox"/>	195MH13	Cobra Mount & Bracket for Specialty Controls	\$410.00
<input type="checkbox"/>	195MH14	Linx Mount & Bracket for Specialty Controls	\$328.00

**Whitmyer Headrest Pad for Specialty controls**

<input type="checkbox"/>	195HE79	Plush Pad 8" for Specialty controls	\$328.00
<input type="checkbox"/>	195HE80	Plush Pad 10" for Specialty controls	\$328.00
<input type="checkbox"/>	195HE81	Plush Pad 14" for Specialty controls	\$328.00

**Extra Swing Away Head Boom Egg Switch and Mount**

	195IJ05	Extra S/A Boom Mount with egg switch #1	\$122.00
	195IJ06	Extra S/A Boom Mount with egg switch #2	\$122.00

**Single Switches**

<input type="checkbox"/>	195IB01	Ribbon Switch	\$127.00
<input type="checkbox"/>	195IB02	Buddy Button Switch	\$114.00
<input type="checkbox"/>	195IB03	Disc Switch	\$214.00
<input type="checkbox"/>	195IB04	Wobble Switch	\$668.00
<input type="checkbox"/>	195IB05	Micro Light Switch	\$101.00
<input type="checkbox"/>	195IB06	Egg Switch-Black	\$142.00
<input type="checkbox"/>	195IB07	Switch-It Mini 1 button on Mono plug	\$284.00

## 6. SEAT TYPE

<input type="checkbox"/> 195ST56	Quickie ASAP II (Adjustable Seating and Positioning) Choose Seat Frame Size Platform.	NC
----------------------------------	---	----

ASAP II Frame size			
<i>(each frame is width and depth adjustable within given range. )</i>			
<input type="checkbox"/> 195FU17	Adjustable 12x12 to 16X19 ( A )		NC
<input type="checkbox"/> 195FU18	Adjustable 16x12 to 20x20 ( B )		NC
<input type="checkbox"/> 195FU19	Adjustable 18x16 to 22x22 ( C )		NC

## 7. SEAT SIZE

### Seat Size Matrix. *Seat type is chosen in section 5.*

A = ASAP II Seat Frame Adjustable from 12x12 to 16X19  
 B = ASAP II Seat Frame Adjustable from 16X12 to 20X20  
 C = ASAP II Seat Frame Adjustable from 18X16 to 22X22

		ASAPII Seat Width (Adjustable)									
		12"	13"	14"	15"	16"	17"	18"	19"	20"	22"
Seat Depth (Adjustable)	12"	A	A	A	A	A,B	B	B	B	B	
	13"	A	A	A	A	A,B	B	B	B	B	
	14"	A	A	A	A	A,B	B	B	B	B	
	15"	A	A	A	A	A,B	B	B	B	B	
	16"	A	A	A	A	A,B	B	B,C	B,C	B,C	C
	17"	A	A	A	A	A,B	B	B,C	B,C	B,C	C
	18"	A	A	A	A	A,B	B	B,C	B,C	B,C	C
	19"	A	A	A	A	A,B	B	B,C	B,C	B,C	C
	20"					B	B	B,C	B,C	B,C	C
	21"							C	C	C	C
22"							C	C	C	C	

Seat Width			
<input type="checkbox"/> 195R21	12"	Seat width	NC
<input type="checkbox"/> 195R22	13"	Seat width	NC
<input type="checkbox"/> 195R23	14"	Seat width	NC
<input type="checkbox"/> 195R24	15"	Seat width	NC
<input type="checkbox"/> 195R5	16"	Seat width	NC
<input type="checkbox"/> 195R6	17"	Seat width	NC
<input type="checkbox"/> 195R7	18"	Seat width	NC
<input type="checkbox"/> 195R8	19"	Seat width	NC
<input type="checkbox"/> 195R9	20"	Seat width	NC
<input type="checkbox"/> 195R25	22"	Seat width	NC

Seat Depth			
<input type="checkbox"/> 195RF20	12"	Seat depth	NC
<input type="checkbox"/> 195RF21	13"	Seat depth	NC
<input type="checkbox"/> 195RF22	14"	Seat depth	NC
<input type="checkbox"/> 195RF23	15"	Seat depth	NC
<input type="checkbox"/> 195RF5	16"	Seat depth	NC
<input type="checkbox"/> 195RF6	17"	Seat depth	NC
<input type="checkbox"/> 195RF7	18"	Seat depth	NC
<input type="checkbox"/> 195RF8	19"	Seat depth	NC
<input type="checkbox"/> 195RF24	20"	Seat depth	NC
<input type="checkbox"/> 195RF25	21"	Seat depth	NC
<input type="checkbox"/> 195RF26	22"	Seat depth	NC

## 8. SEAT CUSHIONS

### JAY Cushion Bundling

<input type="checkbox"/> 195JC14	Jay Cushion <u>On Chair Order</u> Choose Cushion in section 17c.	NC
----------------------------------	---	----

## 9. POWERED SEATING

### Power Seating Options

<input type="checkbox"/>	195PJ2	Quickie SPOT 50° CG Tilt (1 Actuator)	\$4,799.00
--------------------------	--------	---------------------------------------	------------

### Power Seating Control

#### Powered Seating Switch Control Method

*(For use with power seating actuators. Switch activation is stand-alone and does not require expandable or thru-drive electronics.)*

#### Single Actuator Switch Control (Tilt)

<input type="checkbox"/>	195EO10	Switch Control 1 actuator with <u>Dual Toggle</u>	NC
<input type="checkbox"/>	195EO11	Switch Control 1 actuator with <u>Buddy Button</u>	NC
<input type="checkbox"/>	195EO19	Switch Control 1 actuator with Switch-It Mini 1 button	NC
<input type="checkbox"/>	195EO20	Switch Control 1 actuator with Switch-It Mini 2 button	NC

#### 2-3 Actuator Switch Control (Tilt/Legs or Legs only)

<input type="checkbox"/>	195EO21	Switch Control 2-3 actuator with <u>Dual Toggle</u>	\$796.00
<input type="checkbox"/>	195EO12	Switch Control 2-3 actuator with <u>4-way toggle</u>	\$796.00
<input type="checkbox"/>	195EO23	Switch Control 2-3 actuator with Switch-It Mini 2 button	\$796.00
<input type="checkbox"/>	195EO22	Switch Control 2-3 actuator with Switch-It Mini 4 button	\$796.00

#### Switch Mount

*(for use with switch control powered seating)*

<input type="checkbox"/>	195EY01	Switch Mount Right	NC
<input type="checkbox"/>	195EY02	Switch Mount Left	NC

#### Powered Seating Thru-drive Control Method.

##### Thru-Drive 1 Actuator

<input type="checkbox"/>	195EO28	Thru Drive 1 Actuator (For operating Tilt thru Joystick.) Includes Ctrl+5 when ordered with Rnet.	\$1,858.00
--------------------------	---------	---	------------

##### Thru-Drive 2+ Actuator (Requires Rnet)

<input type="checkbox"/>	195EO29	Thru Drive 2+ Actuators: (For operating Tilt, power legs) Includes Ctrl+5	\$3,809.00
--------------------------	---------	---	------------

#### Powered Seating Thru-drive Control Options

##### Assignable Buttons (Requires Rnet)

"Assignable Button" feature allows for customization of joystick buttons and/or Ctrl+5 Switches allowing access to various wheelchair and seating functions. When enabled, chair will be pre-programmed with seating functions assigned to buttons on the joystick. Assignments can be changed via PC Dongle.

<input type="checkbox"/>	195PM01	Enable Assignable buttons	\$656.00
--------------------------	---------	---------------------------	----------

##### Ctrl+5 Switchbox Options (Requires Rnet)

Ctrl+5 allows direct control to 5 power seating functions (10 total switches). Switches can also be used with assignable buttons for greater flexibility. Box includes 3-Amp USB port for charging portable devices

<input type="checkbox"/>	195QG01	Ctrl+5 Switchbox mounted behind joystick	\$656.00
<input type="checkbox"/>	195QG02	Ctrl+5 Switchbox mounted opposite joystick	\$656.00
<input type="checkbox"/>	195QG03	Ctrl+5 Switchbox mounted on back cane	\$656.00
<input type="checkbox"/>	195QG05	Omit Ctrl+5	(\$656.00)



#### Ctrl+5 Switch Type

<input type="checkbox"/>	195EY03	Push buttons	NC
<input type="checkbox"/>	195EY04	Toggle switches	\$328.00

## 10. BACKREST AND BACK OPTIONS FOR ASAP II SEAT

#### Backrest Frame Type

<input type="checkbox"/>	195BT8	Angle Adjustable	NC
<input type="checkbox"/>	195BT98	Manual Recline 40° (not width adjust.)	\$569.00

#### Manual Recline Adjustment Method Option

*Back Height 23". Fits all seat types. NA with Cantilever Arms*

<input type="checkbox"/>	195MN01	Tool	NC
<input type="checkbox"/>	195MN02	Knob (NA with dual post arms.)	NC

#### Angle Adjustable Backrest Options

*(NA with Manual recline)*

<input type="checkbox"/>	195OD8	Non-Folding Backrest	NC
<input type="checkbox"/>	195OD9	Folding Backrest (Max weight 250lbs)	\$145.00

#### Back Cane Angle

<input type="checkbox"/>	195BP40	Straight Back Post	NC
<input type="checkbox"/>	195BP41	8° Bend Back Post (Avail. only J3 Back) NA with Manual recline	\$134.00

#### Back Cane height

<input type="checkbox"/>	195B1	Fixed Low (15.5")	NC
<input type="checkbox"/>	195B5	Fixed Med (17.5")	NC
<input type="checkbox"/>	195B9	Fixed Tall (19.5")	NC
<input type="checkbox"/>	195B243	Adjustable Low 14" - 18"	NC
<input type="checkbox"/>	195B244	Adjustable High 20" - 26"	NC

#### Towel Bar Depth

<input type="checkbox"/>	195QT03	Shallow (NA with Upholstery backs.)	NC
<input type="checkbox"/>	195QT04	Deep (Ext. 4" from back canes for deep backs)	NC

#### Back Type (Upholstery or Solid)

<input type="checkbox"/>	195BU76	S.P.O.T. Curved	NC
<input type="checkbox"/>	195BU77	JAY SPO Posterior	\$634.00
<input type="checkbox"/>	195BU14	Omit Upholstery	(\$15.00)

#### JAY J3 Option (select Omit above)

<input type="checkbox"/>	195JB08	JAY J3 <u>On Chair Order</u> Choose back, headrest, laterals in section 17a,b,c	NC
--------------------------	---------	--	----

#### Back Height - Required for SPOT Curved and SPO Backs.

*(Limited combinations of widths) Measured from pan to top of solid back.*

<input type="checkbox"/>	195B132	14"	NC
<input type="checkbox"/>	195B36	16"	NC
<input type="checkbox"/>	195B38	18"	NC
<input type="checkbox"/>	195B40	20"	NC
<input type="checkbox"/>	195B42	22"	NC
<input type="checkbox"/>	195B44	24"	NC
<input type="checkbox"/>	195B140	26"	NC

## 12. HEADREST OPTIONS

For use with SPOT, and JAY SPO Backrest Only. Choose One Each.

Whitmyer Headrest Mount			
<input type="checkbox"/>	195MH10	Axys Mount & Bracket	\$334.00
<input type="checkbox"/>	195MH11	Cobra Mount and Bracket	\$613.00
<input type="checkbox"/>	195MH1	Linx Mount and Bracket	\$251.00

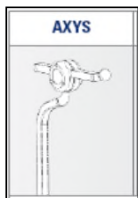

Whitmyer Headrest Pad			
<input type="checkbox"/>	195HE65	Plush Head Support Pad 8"	\$251.00
<input type="checkbox"/>	195HE66	Plush Head Support Pad 10"	\$251.00
<input type="checkbox"/>	195HE78	Plush Head Support Pad 14"	\$251.00
<input type="checkbox"/>	195HE82	Adjust-A-Plush Head Support Pad Narrow	\$387.00
<input type="checkbox"/>	195HE83	Adjust-A-Plush Head Support Pad STD	\$387.00

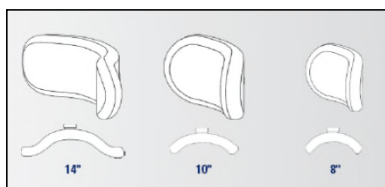

## 13. POSTURAL SUPPORTS

LATERAL THORACIC SUPPORT (Swing Away)			
Available on SPOT and JAY SPO Solid Backs.			
<input type="checkbox"/>	<b>LAT 4X4 S/A MOUNTS W/ 1" OFFSET - PR</b>		<b>\$434.00</b>
	195ZV14	LATERAL 4X4 W/ 1" OFFSET - PAIR	\$134.00
	195ZS07	LATERAL SWING AWAY MOUNT - PAIR	\$300.00
<input type="checkbox"/>	<b>LAT 4X5 S/A MOUNTS W/ 1" OFFSET - PR</b>		<b>\$434.00</b>
	195ZV15	LATERAL 4X5 W/ 1" OFFSET - PAIR	\$134.00
	195ZS07	LATERAL SWING AWAY MOUNT - PAIR	\$300.00
<input type="checkbox"/>	<b>LAT 4X6 S/A MOUNTS W/ 1" OFFSET - PR</b>		<b>\$434.00</b>
	195ZV16	LATERAL 4X6 W/ 1" OFFSET - PAIR	\$134.00
	195ZS07	LATERAL SWING AWAY MOUNT - PAIR	\$300.00
<input type="checkbox"/>	<b>LAT 6X4 S/A MOUNTS W/ 1" OFFSET - PR</b>		<b>\$434.00</b>
	195ZV17	LATERAL 6X4 W/ 1" OFFSET - PAIR	\$134.00
	195ZS07	LATERAL SWING AWAY MOUNT - PAIR	\$300.00
<input type="checkbox"/>	<b>LAT 6X5 S/A MOUNTS W/ 1" OFFSET - PR</b>		<b>\$434.00</b>
	195ZV18	LATERAL 6X5 W/ 1" OFFSET - PAIR	\$134.00
	195ZS07	LATERAL SWING AWAY MOUNT - PAIR	\$300.00
<input type="checkbox"/>	<b>LAT 6X6 S/A MOUNTS W/ 1" OFFSET - PR</b>		<b>\$434.00</b>
	195ZV19	LATERAL 6X6 W/ 1" OFFSET - PAIR	\$134.00
	195ZS07	LATERAL SWING AWAY MOUNT - PAIR	\$300.00

CHEST STRAP			
<input type="checkbox"/>	195ZR03	E0960 Padded Chest Strap	\$300.00

Swing Away Knee Adductor Supports			
Available only with Fixed and Power Center Mount Legrests. Not available with Dual Post Arm Rests or 2-point Locking Cantilever Arms			
<b>Knee Adductor Supports - LEFT (choose Pad and Arm)</b>			<b>\$528.00</b>
Pad Size			
<input type="checkbox"/>	195KB5	Knee Adductor Pad SM - Left	\$228.00
<input type="checkbox"/>	195KB7	Knee Adductor Pad LG - Left	\$228.00
S/A Arm Size			
<input type="checkbox"/>	195XX04	Swing Away Short - Left	\$300.00
<input type="checkbox"/>	195XX06	Swing Away Long - Left	\$300.00
<b>Knee Adductor Supports - RIGHT (choose Pad and Arm)</b>			<b>\$528.00</b>
Pad Size			
<input type="checkbox"/>	195KB6	Knee Adductor Pad SM - Right	\$228.00
<input type="checkbox"/>	195KB8	Knee Adductor Pad LG - Right	\$228.00
S/A Arm Size			
<input type="checkbox"/>	195XX05	Swing Away Short - Right	\$300.00
<input type="checkbox"/>	195XX07	Swing Away Long - Right	\$300.00
Long Thigh Support w/Removable Mount			
Available with Cantilever Arms, NA with Manual Recline Back, Dual Post, Single Post or Cantilever w/ 2 pt Locking arms.			
<b>SPOT Long Thigh Support - Left</b>			<b>\$434.00</b>
	195TV2	Long Thigh Support - Left	\$134.00
	195TX1	Removable Mount - Left	\$300.00
<b>SPOT Long Thigh Support - Right</b>			<b>\$434.00</b>
	195TV1	Long Thigh Support - Right	\$134.00
	195TX2	Removable Mount - Right	\$300.00

## 14. ARMREST AND ARMPAD OPTIONS

Cantilever Armrest Mounting			
Cantilever Armrests			
(Adjustable length arm pad included (choose Pad setting below, except for Low Arm Option) NA with Manual Recline Back)			
<input type="checkbox"/>	195EG12	STD Cantilever Arm 9"-12" Ht Range	STD
<input type="checkbox"/>	195EG13	Low Cantilever Arm 7"-10" Ht Range (Choose ASAP II pad type and size below)	NC
<input type="checkbox"/>	195EG10	Standard Cantilever Arm w/ 2 Point Locking Post. (9"-10" Ht Range.) NA w/ seat depths below 16"	\$307.00
<input type="checkbox"/>	195EG11	Standard Cantilever Arm w/ 2 Point Locking Post. (11"-12" Ht Range.) NA w/ seat depths below 16"	\$307.00

Single - Dual Post Armrest Mounting			
Single Post Armrests			
<input type="checkbox"/>	195EG14	Single Post Height Adjustable - STD.	\$307.00
<input type="checkbox"/>	195EG15	Single Post Height Adjustable - Low	\$307.00

Dual Post Armrests			
<input type="checkbox"/>	195EG09	Shrt Dual Post Flip Back HT Adj 10"-15"	\$401.00
<input type="checkbox"/>	195EG23	Lng Dual Post Flip Back HT Adj 10"-15"	\$401.00

Pad Type / Size Options for Dual Post / Single Post / Low Cantilever				
Left Arm Pad (NC)		Right Arm Pad (NC)		
<input type="checkbox"/>	195AE01	Desk Length Waterfall (10")	<input type="checkbox"/>	195AB01
<input type="checkbox"/>	195AE02	Full Length Waterfall (14") NA w/Low Cantilever arm	<input type="checkbox"/>	195AB02
<input type="checkbox"/>	195AE03	Desk Length Standard (10")	<input type="checkbox"/>	195AB03
<input type="checkbox"/>	195AE04	Full Length Standard (14") NA w/Low Cantilever arm	<input type="checkbox"/>	195AB04

Cantilever Armpad				
Pad Setting Options for Standard Cantilever Arm				
Left Arm Pad (STD)		Right Arm Pad (STD)		
<input type="checkbox"/>	195AE11	Full Length Cantilever (14")	<input type="checkbox"/>	195AB11
<input type="checkbox"/>	195AE10	Desk Length Cantilever (10")	<input type="checkbox"/>	195AB10



## 15. HANGERS AND FOOTRESTS

Swing-away Hangers			
Non-Powered Swing Away Legrests			
Sold as Pairs			
<input type="checkbox"/>	195H2	70° Swing Away (B)	NC
<input type="checkbox"/>	195H6	90° Swing Away (B) (5.5-9")	NC
<input type="checkbox"/>	195H138	Manual ELR S/A (B) (Avail. with Fixed Centermount, choose below)	\$374.00

Power Elevating Legrests (2 Actuators)			
<input type="checkbox"/>	195H126	Swing Away Power ELR w/ Articulation Pair (B footplates) (N/A for 12" or 13" wide)	\$3,177.00

Swing Away Footplates			
<input type="checkbox"/>	<b>B - Adult Angle Adjust w/Heel Loop for use with 70° hanger and ELR (Pair)</b>		<b>\$217.00</b>
	195F282	Adult Angle Adjustable Footplate	\$217.00
	195HL10	Heel Loop	NC
<input type="checkbox"/>	<b>B - Adult Angle Adjust w/Heel Loop for use with 90° hanger (Pair)</b>		<b>\$217.00</b>
	195F285	Adult Angle Adjustable Footplate	\$217.00
	195HL10	Heel Loop	NC
<input type="checkbox"/>	<b>C - Kids Angle Adjust w/Leg Strap for use with 70° hanger (Pair)</b>		<b>\$274.00</b>
	195F283	Kids Angle Adjustable Footplate	\$217.00
	195LS13	Leg Strap	\$57.00
<input type="checkbox"/>	<b>C - Kids Angle Adjust w/Leg Strap for use with 80° and 90° hanger (Pair)</b>		<b>\$274.00</b>
	195F286	Kids Angle Adjustable Footplate	\$217.00
	195LS13	Leg Strap	\$57.00

Omit Hangers			
<input type="checkbox"/>	195H144	Omit Hangers	(\$15.00)

Hanger Extensions (See range listed in matrix below)			
NOTE: Not all extension tube will be available; depending on the seat height, some extension tube options may not offer enough ground clearance.			
<input type="checkbox"/>	195E16	High Mount Hanger	\$90.00
<input type="checkbox"/>	195E1	Short	NC
<input type="checkbox"/>	195E2	Medium	NC
<input type="checkbox"/>	195E5	Long	NC

Footrest Accessories			
<input type="checkbox"/>	1955A01	Toe Loop (Pair) Only avail on (opt B).	\$49.00
<input type="checkbox"/>	195LS14	Extra Leg Strap	\$57.00
<input type="checkbox"/>	195F279	Omit Footplate and extension tube	NC

Lower Leg Length Matrix (measured seat pan to the top of the footplate surface)						Footplate Matrix		
Hanger Type	Standard	High Mount	Short	Medium	Long	B	F	I
70° Swing Away		7"-14"	13.5"- 16"	16"-18.5"	18"-20.5"	X		
90° Swing Away		5.5-9" Footplate mounts to front of hanger.				X		
Manual ELR S/A			12.5"-17"	14.5"-19"	17"-21"	X		
Power ELR S/A			12"-14"	14"-17"	16.5"-19"	X		
Fixed Cntrmnt ASAP			12.5"-15.5"		14.5"-19.5"	Single Footplate		
Angle Adj Cntrmnt				3"-13"	3"-15"			X
Power Cntrmnt	3"-19"						X	

Centermount Legrests			
Non-Powered Centermount Legrests			
Fixed Centermount Legrests (includes footplate) Plus options below			
<input type="checkbox"/>	195H134	Fixed Center ASAP II Mount Short	NC
<input type="checkbox"/>	195H135	Fixed Center ASAP II Mount Long	NC

Angle Adjustable Centermount Legrests for ASAP II			
<input type="checkbox"/>	195H104	Angle adjustable Centermount Medium 3" - 11.25" Choose Footplate (I or J) infinite and Independent leg length and angle adjustable	\$404.00
<input type="checkbox"/>	195H108	Angle adjustable Centermount Long 3" - 13.25" Choose Footplate (I or J) infinite and Independent leg length and angle adjustable	\$404.00

Power Centermount (2 Actuators)			
<input type="checkbox"/>	195H127	Power Centermount ELR w/7.5" Power Articulation (F) Centermount footplates plus Custom Options Below	\$3,169.00
Power Centermount Footplate Extension Option (For Thru-Drive Operation)			
<input type="checkbox"/>	195IE01	<b>Enable</b> 7.5" Powered footplate extension for transfer assist. (Electronics programmed to allow footplates to be extended <b>with or without</b> legrest being raised)	\$1,639.00
<input type="checkbox"/>	195IE02	<b>Disable</b> Footplate extension for transfers. (Electronics programmed to <b>ONLY</b> extend footplates when legs are raised.)	NC

Centermount Footplates			
<input type="checkbox"/>	<b>F - Centermount Dual Footplate (Pair)</b> (Individually Height (3"-19") and Angle Adjustable)		<b>\$262.00</b>
	195F315	CMT Angle Adjustable Footplates	\$262.00
	195HL14	Padded and Adjustable Heel Block	NC
<input type="checkbox"/>	<b>I - Angle adj Centermount Footplate pair Small</b>		<b>\$218.00</b>
	195F125	Small Angle Adjustable Footplates 5.75" x 6"	\$218.00
<input type="checkbox"/>	<b>J - Angle adj Centermount Footplate pair Large</b>		<b>\$241.00</b>
	195F126	Large Angle Adjustable Footplates 5.75" x 10"	\$241.00

## 16. ACCESSORIES

Wheelchair Tray Table			
<input type="checkbox"/>	1957A01	Tray Table SM Tuffak 12"-14" Pwr	\$351.00
<input type="checkbox"/>	1957A02	Tray Table MED Tuffak 15"-17" Pwr	\$351.00
<input type="checkbox"/>	1957A03	Tray Table LRG Tuffak 18"-20" Pwr	\$351.00

Backpack			
<input type="checkbox"/>	195A1	Black Utility	\$103.00

Accessories			
<input type="checkbox"/>	1958A09	Ram Phone Mount on Round JS tube	\$71.00
<input type="checkbox"/>	1958A10	Ram Tablet Mount on Round JS tube	\$284.00
<input type="checkbox"/>	1958A11	Ram Cup holder	\$71.00
<input type="checkbox"/>	1958A12	Switch-It Remote Stop Switch	\$1,273.00

Positioning Belt - Select for any style seat			
<input type="checkbox"/>	195EJ01	Auto Style Buckle	NC
<input type="checkbox"/>	195EJ02	Belt 2" Aircraft Buckle	\$173.00
<input type="checkbox"/>	195EJ03	Belt 2" Aircraft Buckle Padded	\$188.00

Mounting Accessories (available with All Seats)			
Only one accessory can be mounted at a time.			
<input type="checkbox"/>	195A603	Cane/Crutch Holder	\$106.00
<input type="checkbox"/>	195A604	O2 holder	\$106.00
<input type="checkbox"/>	195A605	Walker holder	\$106.00



# JAY<sup>®</sup> Signature Series Backrest and Accessories

Note: Not all sizes and configurations shown below, for full offering visit [www.sunrisemedical.com](http://www.sunrisemedical.com)

## 17a. JAY BACKREST

Seat width must be equal to or 2" less than selection in section 7.

### JAY J3 Back PA (2.2" Contour Depth)

UT Shells- Heavy Duty TH 2 Point Hardware

<input type="checkbox"/>	195JT01	J3PAUTS16TH	16" Wide J3 Back w/ 16.5" Shell Height	\$924.00
<input type="checkbox"/>	195JT02	J3PAUTS18TH	18" Wide J3 Back w/ 16.5" Shell Height	\$924.00
<input type="checkbox"/>	195JT03	J3PAUTS20TH	20" Wide J3 Back w/ 16.5" Shell Height	\$924.00
<input type="checkbox"/>	195JT04	J3PAUTM16TH	16" Wide J3 Back w/ 18" Shell Height	\$924.00
<input type="checkbox"/>	195JT05	J3PAUTM18TH	18" Wide J3 Back w/ 18" Shell Height	\$924.00
<input type="checkbox"/>	195JT06	J3PAUTM20TH	20" Wide J3 Back w/ 18" Shell Height	\$924.00
<input type="checkbox"/>	195JT07	J3PAUTM22TH	22" Wide J3 Back w/ 18" Shell Height	\$1,812.00
<input type="checkbox"/>	195JT08	J3PAUTT16TH	16" Wide J3 Back w/ 19.5" Shell Height	\$924.00
<input type="checkbox"/>	195JT09	J3PAUTT18TH	18" Wide J3 Back w/ 19.5" Shell Height	\$924.00
<input type="checkbox"/>	195JT10	J3PAUTT20TH	20" Wide J3 Back w/ 19.5" Shell Height	\$924.00

SH Shells- TH 2 Point Hardware

<input type="checkbox"/>	195JT11	J3PASHS18TH	18" Wide J3 Back w/ 21" Shell Height	\$953.00
<input type="checkbox"/>	195JT12	J3PASHS20TH	20" Wide J3 Back w/ 21" Shell Height	\$953.00
<input type="checkbox"/>	195JT13	J3PASHS22TH	22" Wide J3 Back w/ 21" Shell Height	\$1,972.00

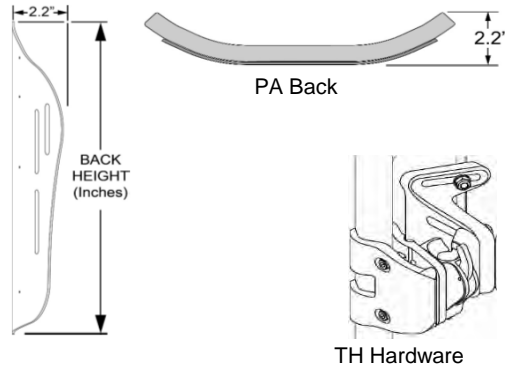

### JAY J3 Back PD (6" Contour Depth)

UT Shells- Heavy Duty TH 2 Point Hardware

<input type="checkbox"/>	195JT14	J3PDUTM16TH	16" Wide J3 Back w/ 18" Shell Height	\$1,052.00
<input type="checkbox"/>	195JT15	J3PDUTM18TH	18" Wide J3 Back w/ 18" Shell Height	\$1,052.00
<input type="checkbox"/>	195JT16	J3PDUTM20TH	20" Wide J3 Back w/ 18" Shell Height	\$1,052.00

SH Shells- Heavy Duty TH 2 Point Hardware

<input type="checkbox"/>	195JT17	J3PDSHS16TH	16" Wide J3 Back w/ 21" Shell Height	\$1,137.00
<input type="checkbox"/>	195JT18	J3PDSHS18TH	18" Wide J3 Back w/ 21" Shell Height	\$1,137.00
<input type="checkbox"/>	195JT19	J3PDSHS20TH	20" Wide J3 Back w/ 21" Shell Height	\$1,137.00

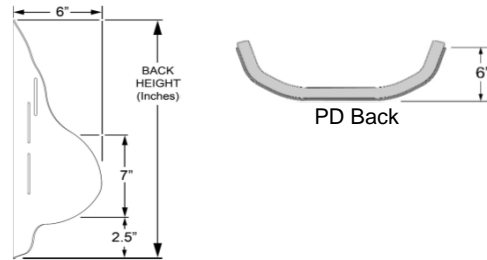

### JAY J3 Back PL (3" Contour Depth)

UT Shells- Heavy Duty TH 2 Point Hardware

<input type="checkbox"/>	195JT20	J3PLUTS16TH	16" Wide J3 Back w/ 16.5" Shell Height	\$992.00
<input type="checkbox"/>	195JT21	J3PLUTS18TH	18" Wide J3 Back w/ 16.5" Shell Height	\$992.00
<input type="checkbox"/>	195JT22	J3PLUTS20TH	20" Wide J3 Back w/ 16.5" Shell Height	\$992.00
<input type="checkbox"/>	195JT23	J3PLUTM16TH	16" Wide J3 Back w/ 18" Shell Height	\$992.00
<input type="checkbox"/>	195JT24	J3PLUTM18TH	18" Wide J3 Back w/ 18" Shell Height	\$992.00
<input type="checkbox"/>	195JT25	J3PLUTM20TH	20" Wide J3 Back w/ 18" Shell Height	\$992.00
<input type="checkbox"/>	195JT26	J3PLUTT16TH	16" Wide J3 Back w/ 19.5" Shell Height	\$992.00
<input type="checkbox"/>	195JT27	J3PLUTT18TH	18" Wide J3 Back w/ 19.5" Shell Height	\$992.00
<input type="checkbox"/>	195JT28	J3PLUTT20TH	20" Wide J3 Back w/ 19.5" Shell Height	\$992.00

SH Shells- TH 2 Point Hardware

<input type="checkbox"/>	195JT29	J3PLSHS18TH	18" Wide J3 Back w/ 21" Shell Height	\$1,020.00
<input type="checkbox"/>	195JT30	J3PLSHS20TH	20" Wide J3 Back w/ 21" Shell Height	\$1,020.00

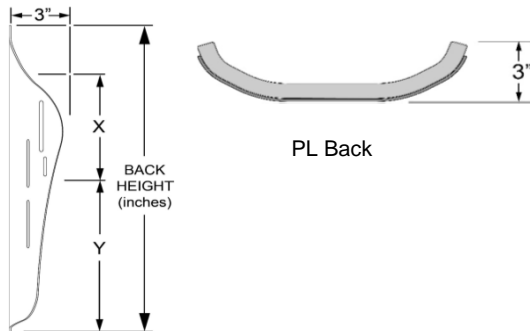

### JAY Custom Back

To order any **JAY Back not listed above**, please see the JAY price list. Cushion name or part number must be filled out w/ desired width and depth

<input type="checkbox"/>	195JB01	JAY Bundled Back	Back Name or Part #	Width:	Height:	Price List
--------------------------	---------	------------------	---------------------	--------	---------	------------

## 17b. JAY BACKREST ACCESSORIES

### JAY J3 Back Headrest

*AXYS Mount and Pad (includes removable mount)*

<input type="checkbox"/>	195HD01	J3HEDX10	AXYS Headrest with 10" Plush Pad	\$529.00
<input type="checkbox"/>	195HD02	J3HEDX14	AXYS Headrest with 14" Plush Pad	\$529.00
<input type="checkbox"/>	195HD05	J3HEDXAAPS	AXYS Headrest with Narrow Adjust-a-Plush	\$667.00
<input type="checkbox"/>	195HD06	J3HEDXAAPN	AXYS Headrest with Standard Adjust-a-Plush	\$667.00

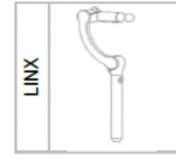
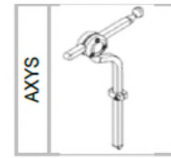

*LINX Mount and Pad (includes removable mount)*

<input type="checkbox"/>	195HD03	J3HEDL10	LINX Headrest with 10" Plush Pad	\$642.00
<input type="checkbox"/>	195HD04	J3HEDL14	LINX Headrest with 14" Plush Pad	\$642.00
<input type="checkbox"/>	195HD07	J3HEDLAAPS	LINX Headrest with Narrow Adjust-a-Plush	\$780.00
<input type="checkbox"/>	195HD08	J3HEDLAAPN	LINX Headrest with Standard Adjust-a-Plush	\$780.00

### JAY J3 Back Laterals

*Swing Away Laterals With Pad - Pair*

<input type="checkbox"/>	195JW02	J3LAT4X4SA	SwingAway Lat with 4"x4" Pad (PR)	\$624.00
<input type="checkbox"/>	195JW03	J3LAT4X5SA	SwingAway Lat with 4"x5" Pad (PR)	\$624.00
<input type="checkbox"/>	195JW04	J3LAT4X6SA	SwingAway Lat with 4"x6" Pad (PR)	\$624.00

## 17c. JAY CUSHIONS

*Seat width must match selection in section 7. Seat depth can be +/- 2" of selection in section 7*

#### JAY Fusion Cushion

<input type="checkbox"/>	195JU01	JFUSION1616	JAY Fusion 16" x 16"	\$976.00
<input type="checkbox"/>	195JU02	JFUSION1618	JAY Fusion 16" x 18"	\$976.00
<input type="checkbox"/>	195JU03	JFUSION1816	JAY Fusion 18" x 16"	\$976.00
<input type="checkbox"/>	195JU04	JFUSION1818	JAY Fusion 18" x 18"	\$976.00
<input type="checkbox"/>	195JU05	JFUSION1820	JAY Fusion 18" x 20"	\$976.00
<input type="checkbox"/>	195JU06	JFUSION2018	JAY Fusion 20" x 18"	\$976.00
<input type="checkbox"/>	195JU07	JFUSION2020	JAY Fusion 20" x 20"	\$976.00

#### JAY X2 Cushion

<input type="checkbox"/>	195JU22	JX21616	JAY X2 16" x 16"	\$881.00
<input type="checkbox"/>	195JU23	JX21618	JAY X2 16" x 18"	\$881.00
<input type="checkbox"/>	195JU24	JX21816	JAY X2 18" x 16"	\$881.00
<input type="checkbox"/>	195JU25	JX21818	JAY X2 18" x 18"	\$881.00
<input type="checkbox"/>	195JU26	JX21820	JAY X2 18" x 20"	\$881.00
<input type="checkbox"/>	195JU27	JX22020	JAY X2 20" x 20"	\$881.00

#### JAY Union Cushion

<input type="checkbox"/>	195JU15	JU1616	JAY UNION 16" x 16"	\$714.00
<input type="checkbox"/>	195JU16	JU1618	JAY UNION 16" x 18"	\$714.00
<input type="checkbox"/>	195JU17	JU1816	JAY UNION 18" x 16"	\$714.00
<input type="checkbox"/>	195JU18	JU1818	JAY UNION 18" x 18"	\$714.00
<input type="checkbox"/>	195JU19	JU1820	JAY UNION 18" x 20"	\$753.00
<input type="checkbox"/>	195JU20	JU2018	JAY UNION 20" x 18"	\$753.00
<input type="checkbox"/>	195JU21	JU2020	JAY UNION 20" x 20"	\$753.00

#### JAY Ion Cushion

<input type="checkbox"/>	195JU08	JION1616	JAY ION 16" x 16"	\$613.00
<input type="checkbox"/>	195JU09	JION1618	JAY ION 16" x 18"	\$613.00
<input type="checkbox"/>	195JU10	JION1816	JAY ION 18" x 16"	\$613.00
<input type="checkbox"/>	195JU11	JION1818	JAY ION 18" x 18"	\$613.00
<input type="checkbox"/>	195JU12	JION1820	JAY ION 18" x 20"	\$613.00
<input type="checkbox"/>	195JU13	JION2018	JAY ION 20" x 18"	\$652.00
<input type="checkbox"/>	195JU14	JION2020	JAY ION 20" x 20"	\$652.00

### JAY Custom Cushion

*To order any **JAY cushions not listed above**, please see the JAY price list. Cushion name or part number must be filled out w/ desired width and depth*

<input type="checkbox"/>	195JC20	JAY Bundled Cushion	Cushion Name or Part # <input style="width: 100px;" type="text"/>	Width: <input style="width: 50px;" type="text"/>	Depth: <input style="width: 50px;" type="text"/>	Price List
--------------------------	---------	---------------------	---	--	--	------------

## 18. CUSTOM OPTIONS



Looking for more options? Contact our custom "Built-4-Me" department.

Below are common upgrades that utilize **Ready Made Quotes**. These options can be quickly quoted to add a custom touch to your Pulse power chair.

<input type="checkbox"/>	Lights and Indicators	Call for quote
<input type="checkbox"/>	Gel Flat 2" arm pads	Call for quote
<input type="checkbox"/>	Gel Flat 4" arm pads	Call for quote
<input type="checkbox"/>	Gel Trough/Elbow Block Medium (3.4" x 13") arm pads	Call for quote
<input type="checkbox"/>	Gel Trough/Elbow Block Large (4"x 14.5") arm pads	Call for quote

*Some Restrictions Apply*

To Inquire about any unique customization for Quicke products, contact:  
Phone: (800) 263-3390, or Fax: (800) 561-5834

