



JAY[®] Zip Pediatric Backrest

July 2016



Mark For: Date: _____ Dealer Acct #: _____ Dealer: _____ Dealer Contact: _____ Dealer Address: _____ Dealer City: _____ ST: _____ ZIP: _____ Dealer Phone: () _____ Fax: () _____ Confirmation Email: _____ Confirm Via: <input type="checkbox"/> Fax <input type="checkbox"/> Email	Submitting for: <input type="checkbox"/> Quote <input type="checkbox"/> Order PO#: _____ <div style="text-align: center;">ADDITIONAL SHIPPING INFORMATION</div> Ship To: _____ Attention: _____ Address: _____ Address: _____ Ship To City: _____ ST: _____ ZIP: _____ Ship To Phone: () _____ Fax: () _____
--	---

JAY ZIP BACK

<input type="checkbox"/>	JZIPBXXY	JAY Zip Backrest All Sizes	\$893.00
<i>NOTE: Select appropriate assembly number below.</i>			
<i>165 lbs Weight Capacity</i>			

EACH BACK SHIPS WITH THE FOLLOWING:
Ultra lightweight mounting hardware 1.6" of anterior depth adjustment, 3" with reversing hardware provided 10mm Combo Wrench Angle Adjustability from -20° to +20° Neoprene Backrest Hardware Covers (Allows for quick release) Water resistant inner cover & Anti-microbial outer cover Adjustable lumbar support

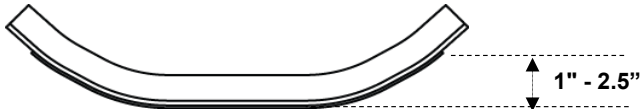

BACKREST WIDTH	8"	10"	12"	14"
FITS BACK CANE WIDTHS	8"-9"	10"-11"	12"-13"	14"-15"
MAX. USER TRUNK WIDTH	7"	9"	11"	13"
ACTUAL SHELL WIDTH	5.6"	7.6"	9.6"	11.6"
DEPTH OF CONTOUR	1"	1.5"	2"	2.5"

NEW!

		Backrest Width			
		8"	10"	12"	14"
Backrest Height	 6" (S)	<input type="checkbox"/> JZIPB08S	<input type="checkbox"/> JZIPB10S	<input type="checkbox"/> JZIPB12S	<input type="checkbox"/> JZIPB14S
	 8" (M)	<input type="checkbox"/> JZIPB08M	<input type="checkbox"/> JZIPB10M	<input type="checkbox"/> JZIPB12M	<input type="checkbox"/> JZIPB14M
	 10" (T)	<input type="checkbox"/> JZIPB08T	<input type="checkbox"/> JZIPB10T	<input type="checkbox"/> JZIPB12T	<input type="checkbox"/> JZIPB14T
	 12" (X)	<input type="checkbox"/> JZIPB08X	<input type="checkbox"/> JZIPB10X	<input type="checkbox"/> JZIPB12X	<input type="checkbox"/> JZIPB14X

The JAY ZIP Backrest has been dynamically tested and meets all criteria for use in motor vehicles according to Section 5.1 of ISO 16840-4 and Section 20, ANSI/RESNA WC/Volume 4. Please visit www.sunparts.us for spare parts information.

JAY ZIP BACK ACCESSORIES

JAY ZIP Back accessories are optional. All accessories will be factory mounted as much as possible to insure proper shipping.

LATERAL SUPPORTS

Use this section for lateral supports.

FIXED LATERAL THORACIC SUPPORT

Includes fixed mounting hardware.

<input type="checkbox"/>	JZFX34F	LAT ZIP FIXED 3X4 FLAT	\$295.00	<input type="checkbox"/>	JZFX34C	LAT ZIP FIXED 3X4 CURVE	\$295.00
<input type="checkbox"/>	JZFX45F	LAT ZIP FIXED 4X5 FLAT	\$295.00	<input type="checkbox"/>	JZFX45C	LAT ZIP FIXED 4X5 CURVE	\$295.00

SWING-AWAY LATERAL THORACIC SUPPORT

Includes swing-away mounting hardware and all laterals are sold in pairs.

<input type="checkbox"/>	JZSA34F	LAT 3X4 FLAT W/ S/A MOUNT	\$588.00	<input type="checkbox"/>	JZSA34CO	LAT 3X4 CRV 1" OFF W/ S/A MNT	\$588.00
	JZ34F	LAT ZIP 3X4 FLAT	\$263.00		JZ34CO	LAT 3X4 CURVE W/ 1" OFFSET	\$263.00
	JZSAMNT	LATERAL SWING AWAY MOUNT	\$325.00		JZSAMNT	LATERAL SWING AWAY MOUNT	\$325.00
<input type="checkbox"/>	JZSA45F	LAT 4X5 FLAT W/ S/A MOUNT	\$588.00	<input type="checkbox"/>	JZSA45CO	LAT 4X5 CRV 1" OFF W/ S/A MNT	\$588.00
	JZ45F	LAT ZIP 4X5 FLAT	\$263.00		JZ45CO	LAT 4X5 CURVE W/ 1IN OFFSET	\$263.00
	JZSAMNT	LATERAL SWING AWAY MOUNT	\$325.00		JZSAMNT	LATERAL SWING AWAY MOUNT	\$325.00
<input type="checkbox"/>	JZSA34C	LAT 3X4 CURVE W/ S/A MOUNT	\$588.00	<input type="checkbox"/>	JZSA34FOA	LAT 3X4 FLAT ADJ 1" OFF W/ S/A	\$588.00
	JZ34C	LAT ZIP 3X4 CURVE	\$263.00		JZ34FOA	LAT 3X4 FLAT W/ ADJ 1" OFFSET	\$263.00
	JZSAMNT	LATERAL SWING AWAY MOUNT	\$325.00		JZSAMNT	LATERAL SWING AWAY MOUNT	\$325.00
<input type="checkbox"/>	JZSA45C	LAT 4X5 CURVE W/ S/A MOUNT	\$588.00	<input type="checkbox"/>	JZSA45FOA	LAT 4X5 FLAT ADJ 1" OFF W/ S/A	\$588.00
	JZ45C	LAT ZIP 4X5 CURVE	\$263.00		JZ45FOA	LAT 4X5 FLAT W/ ADJ 1" OFFSET	\$263.00
	JZSAMNT	LATERAL SWING AWAY MOUNT	\$325.00		JZSAMNT	LATERAL SWING AWAY MOUNT	\$325.00
<input type="checkbox"/>	JZSA34FO	LAT 3X4 FLT 1" OFF W/ S/A MNT	\$588.00	<input type="checkbox"/>	JZSA34COA	LAT 3X4 CRV ADJ 1" OFF W/ S/A	\$588.00
	JZ34FO	LAT ZIP 3X4 FLAT W/ 1" OFFSET	\$263.00		JZ34COA	LAT 3X4 CRV W/ ADJ 1" OFFSET	\$263.00
	JZSAMNT	LATERAL SWING AWAY MOUNT	\$325.00		JZSAMNT	LATERAL SWING AWAY MOUNT	\$325.00
<input type="checkbox"/>	JZSA45FO	LAT 4X5 FLT 1" OFF W/ S/A MNT	\$588.00	<input type="checkbox"/>	JZSA45COA	LAT 4X5 CRV ADJ 1" OFF W/ S/A	\$588.00
	JZ45FO	LAT ZIP 4X5 FLAT W/ 1" OFFSET	\$263.00		JZ45COA	LAT 4X5 CRV W/ ADJ 1" OFFSET	\$263.00
	JZSAMNT	LATERAL SWING AWAY MOUNT	\$325.00		JZSAMNT	LATERAL SWING AWAY MOUNT	\$325.00

LATERAL MEASURING GUIDE (Fixed and Swing Away)

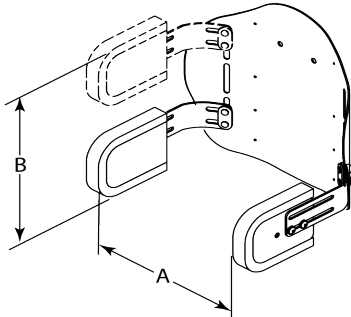

DIM	Description	Back Width			
		8" Wide	10" Wide	12" Wide	14" Wide
A	Lateral Adjustment Range (Min Spacing - Max Spacing)	3.8" - 4.8"	5.1" - 6.1"	6.8" - 7.8"	8.4" - 9.4"
		Not Available			
B	Lateral Height Range (Measured from bottom edge of shell to top of lateral)	6" Tall Back	Not Available		
		8" Tall Back	7"		
		10" Tall Back	9"		
		12" Tall Back	10"		

HEADRESTS

<input type="checkbox"/>	JZHED6	Headrest w/ Pad - 6" Plush	\$432.00
	JPLSH06	Pad - 6" Plush	\$285.00
	JZIPBHH	Onyx post w/ Axy's Hardware	\$147.00
<input type="checkbox"/>	JZHED8	Headrest w/ Pad - 8" Plush	\$437.00
	JPLSH08	Pad - 8" Plush	\$290.00
	JZIPBHH	Onyx post w/ Axy's Hardware	\$147.00
<input type="checkbox"/>	JZHEDCINF	Headrest w/ Pad - 6" Contoured	\$403.00
	JCNTR06	Pad - 6" Contoured Cradle	\$256.00
	JZIPBHH	Onyx post w/ Axy's Hardware	\$147.00
<input type="checkbox"/>	JZHEDCS	Headrest w/ Pad - 8" Contoured	\$417.00
	JCNTR08	Pad - 8" Contoured Cradle	\$270.00
	JZIPBHH	Onyx post w/ Axy's Hardware	\$147.00

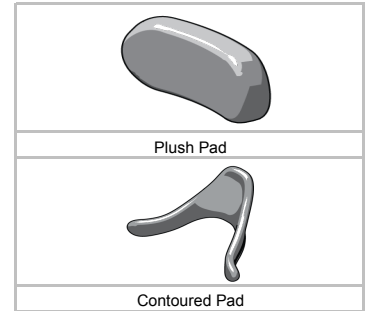
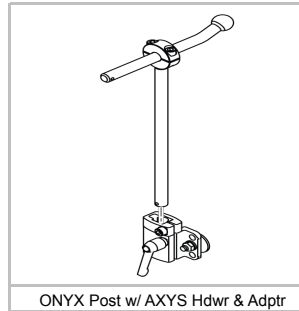





VANITY FLAP

Vanity flaps are NOT INCLUDED as a standard option with the JAY ZIP Back.

<input type="checkbox"/>	VF08	8" to 9" Wide	\$79.00	<input type="checkbox"/>	VF12	12" to 13" Wide	\$79.00
<input type="checkbox"/>	VF10	10" to 11" Wide	\$79.00	<input type="checkbox"/>	VF14	14" to 15" Wide	\$79.00

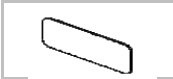
SPINE ALIGN POSITIONING COMPONENTS

<input type="checkbox"/>	J3SPNCR	Curved Shim	\$32.00	<input type="checkbox"/>	J3SPNBL	Large Bean Bag	\$37.00
<input type="checkbox"/>	J3SPNBS	Small Bean Bag	\$37.00	<input type="checkbox"/>	J3SPNLS	Lateral Shim	\$58.00
<input type="checkbox"/>	J3SPNFL	Flat Shim	\$32.00	<input type="checkbox"/>	J3SPNLP	Posterior/Lateral Pelvic	\$58.00

						
	Curved Slim	Flat	Lateral Slim	Sm Bean Bag	Lg Bean Bag	Post/Lat Pelvic
W	10"	10"	2.4"	6"	10"	5.3"
H	4"	4"	4.3"	4.5"	3.2"	3.6"
D	0.5"	0.3"	0.5"	0.75"	0.75"	0.75"

CHEST STRAPS & HARNESSSES

Chest Straps & Harnesses include guide brackets and hardware.

<input type="checkbox"/>	JZ9407	Center Opening w/ Buckle (EI)	\$210.00	<input type="checkbox"/>	JZ9107	Contoured - Dynamic Pull Down (EI)	\$210.00
<input type="checkbox"/>	JZ9400	Center Opening w/ Buckle (XS)	\$210.00	<input type="checkbox"/>	JZ9100	Contoured - Dynamic Pull Down(XS)	\$210.00
<input type="checkbox"/>	JZ9401	Center Opening w/ Buckle (S)	\$210.00	<input type="checkbox"/>	JZ9101	Contoured - Dynamic Pull Down (S)	\$210.00
<input type="checkbox"/>	JZ9402	Center Opening w/ Buckle (M)	\$210.00	<input type="checkbox"/>	JZ9102	Contoured - Dynamic Pull Down (M)	\$210.00
<input type="checkbox"/>	JZ8107	Classic - Dynamic Pull Down (EI)	\$210.00	<input type="checkbox"/>	JZ9300	Contoured - Strctrd Pull Down (XS)	\$210.00
<input type="checkbox"/>	JZ8100	Classic - Dynamic Pull Down (XS)	\$210.00	<input type="checkbox"/>	JZ9301	Contoured - Strctrd Pull Down (S)	\$210.00
<input type="checkbox"/>	JZ8101	Classic - Dynamic Pull Down (S)	\$210.00	<input type="checkbox"/>	JZ9302	Contoured - Strctrd Pull Down (M)	\$210.00
<input type="checkbox"/>	JZ8102	Classic - Dynamic Pull Down (M)	\$210.00	<input type="checkbox"/>	JZ4050	Padded Anterior Trunk Straps (XS)	\$210.00
<input type="checkbox"/>	JZ8300	Classic - Structured Pull Down (XS)	\$210.00	<input type="checkbox"/>	JZ4000	Padded Anterior Trunk Straps (S)	\$210.00
<input type="checkbox"/>	JZ8301	Classic - Structured Pull Down (S)	\$210.00	<input type="checkbox"/>	JZ4100	Padded Anterior Trunk Straps (M)	\$210.00
<input type="checkbox"/>	JZ8302	Classic - Structured Pull Down (M)	\$210.00				

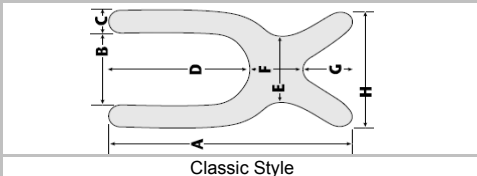
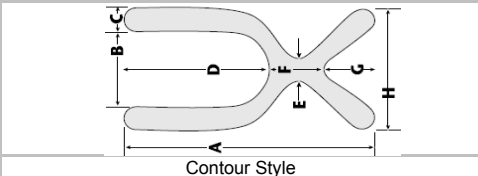
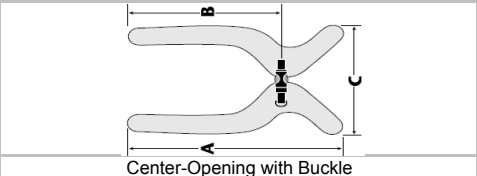
																																																																																																																
Classic Style	Contour Style	Center-Opening with Buckle																																																																																																														
<table border="1"> <tr><th></th><th>A</th><th>B</th><th>C</th><th>D</th><th>E</th><th>F</th><th>G</th><th>H</th></tr> <tr><td>EI</td><td>9.8"</td><td>3"</td><td>2"</td><td>5.3"</td><td>3"</td><td>3"</td><td>1"</td><td>6.5"</td></tr> <tr><td>XS</td><td>12.5"</td><td>3.5"</td><td>2"</td><td>7.5"</td><td>3.5"</td><td>3"</td><td>2"</td><td>7.5"</td></tr> <tr><td>S</td><td>15"</td><td>4.5"</td><td>2"</td><td>9"</td><td>4"</td><td>4"</td><td>2"</td><td>8.5"</td></tr> <tr><td>M</td><td>19"</td><td>5.5"</td><td>2"</td><td>11"</td><td>5"</td><td>5"</td><td>3"</td><td>9.5"</td></tr> </table>		A	B	C	D	E	F	G	H	EI	9.8"	3"	2"	5.3"	3"	3"	1"	6.5"	XS	12.5"	3.5"	2"	7.5"	3.5"	3"	2"	7.5"	S	15"	4.5"	2"	9"	4"	4"	2"	8.5"	M	19"	5.5"	2"	11"	5"	5"	3"	9.5"	<table border="1"> <tr><th></th><th>A</th><th>B</th><th>C</th><th>D</th><th>E</th><th>F</th><th>G</th><th>H</th></tr> <tr><td>EI</td><td>9.8"</td><td>3"</td><td>1.8"</td><td>5.3"</td><td>1"</td><td>3.5"</td><td>1.5"</td><td>6.5"</td></tr> <tr><td>XS</td><td>12.5"</td><td>3.5"</td><td>2"</td><td>7.5"</td><td>1"</td><td>3.5"</td><td>1.5"</td><td>7.5"</td></tr> <tr><td>S</td><td>15"</td><td>4.5"</td><td>2"</td><td>9"</td><td>1"</td><td>4"</td><td>2"</td><td>8.5"</td></tr> <tr><td>M</td><td>18.5"</td><td>5.5"</td><td>2"</td><td>11"</td><td>1"</td><td>5"</td><td>2.5"</td><td>9.5"</td></tr> </table>		A	B	C	D	E	F	G	H	EI	9.8"	3"	1.8"	5.3"	1"	3.5"	1.5"	6.5"	XS	12.5"	3.5"	2"	7.5"	1"	3.5"	1.5"	7.5"	S	15"	4.5"	2"	9"	1"	4"	2"	8.5"	M	18.5"	5.5"	2"	11"	1"	5"	2.5"	9.5"	<table border="1"> <tr><th></th><th>A</th><th>B</th><th>C</th></tr> <tr><td>EI</td><td>9.8"</td><td>7"</td><td>5"</td></tr> <tr><td>XS</td><td>11"</td><td>8"</td><td>5.8"</td></tr> <tr><td>S</td><td>12.3"</td><td>9"</td><td>6.5"</td></tr> <tr><td>M</td><td>14.3"</td><td>11"</td><td>9.8"</td></tr> </table>		A	B	C	EI	9.8"	7"	5"	XS	11"	8"	5.8"	S	12.3"	9"	6.5"	M	14.3"	11"	9.8"
	A	B	C	D	E	F	G	H																																																																																																								
EI	9.8"	3"	2"	5.3"	3"	3"	1"	6.5"																																																																																																								
XS	12.5"	3.5"	2"	7.5"	3.5"	3"	2"	7.5"																																																																																																								
S	15"	4.5"	2"	9"	4"	4"	2"	8.5"																																																																																																								
M	19"	5.5"	2"	11"	5"	5"	3"	9.5"																																																																																																								
	A	B	C	D	E	F	G	H																																																																																																								
EI	9.8"	3"	1.8"	5.3"	1"	3.5"	1.5"	6.5"																																																																																																								
XS	12.5"	3.5"	2"	7.5"	1"	3.5"	1.5"	7.5"																																																																																																								
S	15"	4.5"	2"	9"	1"	4"	2"	8.5"																																																																																																								
M	18.5"	5.5"	2"	11"	1"	5"	2.5"	9.5"																																																																																																								
	A	B	C																																																																																																													
EI	9.8"	7"	5"																																																																																																													
XS	11"	8"	5.8"																																																																																																													
S	12.3"	9"	6.5"																																																																																																													
M	14.3"	11"	9.8"																																																																																																													

JAY YOUR WAY MODIFICATIONS

Note: To order options offered via JAY Your Way add a "M" to the front of the part number and follow the prompts.

For additional modifications visit www.sunrisemedical.com to view even more!

COVER COLOR OPTIONS - Rear Center Flap

<input type="checkbox"/>	COCPI	Pink Semi Stretch Cover	NC
<input type="checkbox"/>	COCB	Blue Semi Stretch Cover	NC
<input type="checkbox"/>	COCPU	Purple Cover	NC
<input type="checkbox"/>	COCR	Red Cover	NC
<input type="checkbox"/>	COCB	Toxic Green Cover	NC

COLOR BACK SHELLS

NEW!

Paint your Zip back shell to match any of the Zippie or Quickie Frame Colors!

<input type="checkbox"/>	XXCBS	Zippie/Quickie Back Shell Paint	NC
--------------------------	-------	---------------------------------	----

Write Desired Back Shell Color Here:

