



### Customer Contact Details

Customer Name: _____	Ship to Customer Address: <input type="checkbox"/>
Advisor: _____	Shipping Name: _____
Address: _____ _____ _____	Shipping Address: _____ _____ _____
Phone: _____	Phone: _____
Email: _____	Email: _____

### Additional Information

Notes: _____ _____ _____ _____	Current Wheelchair: _____
	Customer Weight: _____
	Customer Height: _____
	Customer Disability: _____

Guide:

- Base product
- Required option
- Optional Extra
- Critical Information
- Information Needed

## PRODUCT STYLE

- ELAXZ010 ELITE**  
\$7,633.00
- ELAXA062 Standard Frame
- ELAXA063 Standard Frame with 25mm seatrail
- ELAXA280 Heavy Duty Frame  
\$639.00  
*(Spinergy R10 wheels also required)*

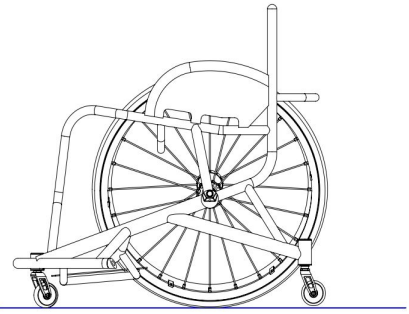

**Max User Weight 125kg (275lbs)**

Yes, I am within the max user weight

## CAD APPROVAL

- |   |   |
|---|---|
| <ul style="list-style-type: none"> <li><input type="checkbox"/> XW012 <b>QUOTE</b> CAD drawing for approval<br/>\$550 FLAT FEE <i>(Includes two free revisions)</i></li> <li><input type="checkbox"/> XW009 <b>QUOTE</b> only no CAD<br/>\$0</li> </ul> | <ul style="list-style-type: none"> <li><input type="checkbox"/> XW010 <b>ORDER</b> CAD drawing for approval<br/>\$300 FLAT FEE <i>(Includes two free revisions)</i></li> <li><input type="checkbox"/> XW011 <b>ORDER</b> only no CAD<br/>\$0</li> </ul> |
|---|---|

## KEY MEASUREMENTS

- XY010 Seat width *(Inside to inside of sideguards)*  
  mm *(Max - 500mm)*
- XY020 Seat length  
  mm *(Max - 500mm)*
- XY030 Extra seat length *(Provides additional leg support & hand grip)*  
  mm
- XY050 Front frame height  
  mm *(Max - 630mm)  
(Min - 360mm)*
- XY060 Rear frame height  
  mm *(Max - 630mm)  
(Min - 360mm)*
- XY070 Frame length  
  mm *(Min = XY020 + XY030 + 140mm)*
- XA020 Ergonomic seat  
\$121.00  
*Specify length*  
  mm *(Standard = 120mm)*

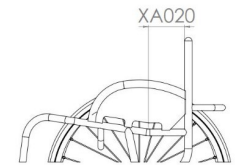
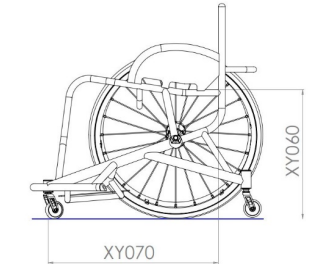
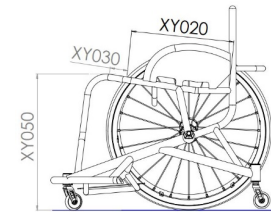
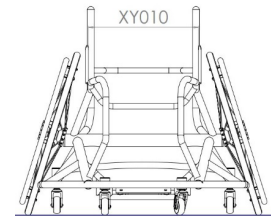

## FRONT FRAME AND SEAT

Front Frame Options (Choose One)

XY080 Seat taper design

**i** Specify taper width  
 mm

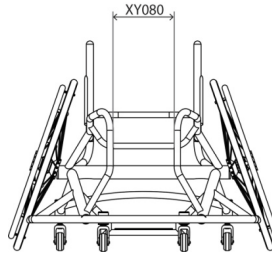

XA130 V-seat design  
 \$307.00

**i** Specify taper width  
 mm

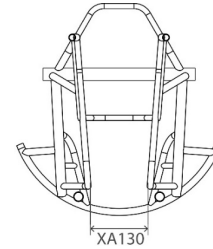

### Advanced Front Frame Options

XY082 Seat taper position  
 \$90.00

**i** Specify measurement  
 mm

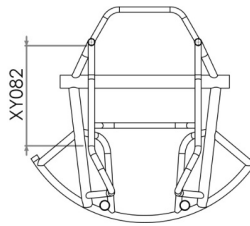

XA131 V-seat and taper design  
 \$331.00

**i** Specify inside width at front of sideguard (A)  
 mm

**i** Specify taper width (B)  
 mm

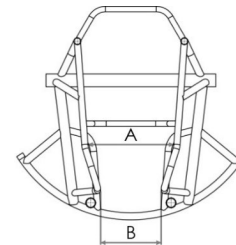

XA136 Parallel taper design  
 \$90.00 (Not with Seat Taper XY080)

**i** Specify taper width  
 mm

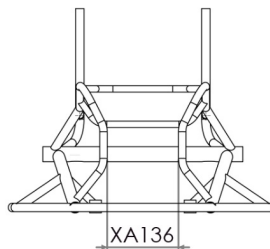

XA135 Asymmetrical taper design  
 \$265.00

**i** Specify taper width (A)  
 mm

**i** Specify offset (B)  
 (Inside of sideguard to inside of taper width)  
 mm

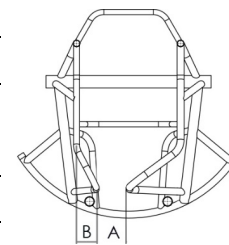

### Seat Options

XR040 Aluminum seat plate  
 \$193.00 (riveted to frame)

**i** Specify length of plate  
 mm (Std XY020 - 20mm)

XA260 Drop seat design  
 \$219.00 (only with either XR040 or 050)

**i** Specify drop  
 mm (Std = 20mm)

XR050 Carbon fibre seat plate  
 \$480.00 (riveted to frame)

**i** Specify length of plate  
 mm (Std XY020 - 20mm)

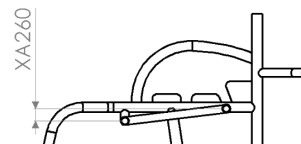

## FOOTREST

Fixed Footrest	Adjustable Footrest
<input type="checkbox"/> ELAXB080 Fixed position footrest	<input type="checkbox"/> ELAXB130 Clamp on adjustable position footrest (\$307.00) (100mm range)
Height and Position	Height and Position
<input type="checkbox"/> Front footrest height <input type="text" value=""/> mm (min = 35mm)	<input type="checkbox"/> Front footrest height <input type="text" value=""/> mm (min = 40mm)
<input type="checkbox"/> Rear footrest height <input type="text" value=""/> mm (min = 35mm)	<input type="checkbox"/> Rear footrest height <input type="text" value=""/> mm (min = 40mm)
<input type="checkbox"/> Footrest position (front of footplate to castor pot) <input type="text" value=""/> mm	<input type="checkbox"/> Footrest position (front of footplate to castor pot) <input type="text" value=""/> mm
Footrest Size (Not ABS)	Footrest Size (Not ABS)
<input type="checkbox"/> Footrest width <input type="text" value=""/> mm (Std= 200mm)	<input type="checkbox"/> Footrest width <input type="text" value=""/> mm (Std= 200mm)
<input type="checkbox"/> Footrest length <input type="text" value=""/> mm (Std = 250mm)	<input type="checkbox"/> Footrest length <input type="text" value=""/> mm (Std = 250mm)
Footrest Plate	Footrest Plate
<input type="checkbox"/> XB180 Aluminium footplate (2.5mm)	<input type="checkbox"/> XB180 Aluminium footplate (5mm)
<input type="checkbox"/> XB190 Carbon fibre footplate \$560.00	<input type="checkbox"/> XB100 ABS moulded foot tray \$183.00
<input type="checkbox"/> XB100 ABS moulded foot tray \$183.00 Specify length <input type="text" value=""/> mm (Max = 380mm (Full) Std = 330mm)	<input type="checkbox"/> XB100 ABS moulded foot tray \$183.00 Specify length <input type="text" value=""/> mm (Max = 380mm (Full) Std = 330mm)
<input type="checkbox"/> ELAXB140 Spacer kit \$127.00 (Allows for 25mm increase in height)	
<input type="checkbox"/> ELAXB145 Multi position footrest tubes \$596.00	
Footrest Plate Options	
<input type="checkbox"/> XB240 Aluminium raised edges (Cost per Edge) \$188.00 <input type="checkbox"/> Front <input type="checkbox"/> Back <input type="checkbox"/> Left <input type="checkbox"/> Right Specify height <input type="text" value=""/> (Max = 60mm)	
Caster Pin Width	
<input checked="" type="checkbox"/> XY330 Caster pin width <input type="text" value=""/> mm <input type="checkbox"/> Optimise measurements	

## CAMBER BAR, WING AND ANTI-TIP

### Centre of Gravity

ELAXY510 Fixed centre of gravity



Specify measurement

 mm

(Note: dimension is taken from front of backrest to centre of axle)

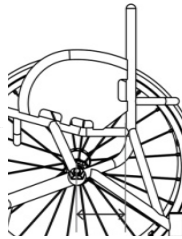

ELAXY515 Backrest COG adjustment (Not with welded sides) (+/-20mm)

Specify measurement

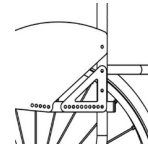
 mm

ELAXY560 Adjustable centre of gravity

Specify measurement

 mm

### Specify Camber Angle

XY390 Camber angle



- 16  
  18  
  20  
  22

### Wing Options

ELAXA110 Round design basketball wing

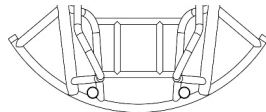

ELAXA125 Arrow design basketball wing \$260.00

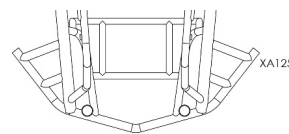

ELAXA120 Straight sided design basketball wing \$260.00

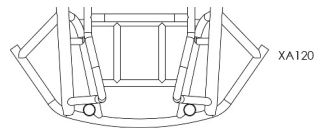

### Anti-tip options

ELAXJ040 Single fixed anti tip

ELAXJ060 Double fixed anti tip \$359.00 (With high mount joining bar)

Specify caster pin width

 mm

Optimize measurements (Wide as possible - std if not indicated)

## SIDEGUARDS

### Sideguard Style

- |   |  |  |  |
|---|--|--|--|
| <input type="checkbox"/> ELAXE230<br>\$540.00 | Welded aluminium sport<br><i>(Not with backrest COG Adj - ELAXY510)</i>      | <input type="checkbox"/> XE030<br>\$327.00 | Screw on aluminium   |
| <input type="checkbox"/> ELAXE250<br>\$254.00 | Welded aluminium tubes only<br><i>(Not with backrest COG Adj - ELAXY510)</i> | <input type="checkbox"/> XE050<br>\$726.00 | Screw on carbon fibre<br><i>(Not recommended for basketball use)</i> |
| <input type="checkbox"/> XE310<br>\$331.00    | High design upgrade<br><i>(Only with option ELAXE230)</i>                    |  |  |

### Sideguard Measurements

- |   |  |  |  |
|---|--|--|--|
| <input type="checkbox"/> Sideguard length   |  | <input type="checkbox"/> Follow Tire Design    |  |
| <input type="checkbox"/> Sideguard height (back)  |  | <input type="checkbox"/> 25mm above tire       |  |
| <input type="checkbox"/> Sideguard height (front)<br><i>(optional for max height players)</i> |  | <input type="checkbox"/> Individual above tire |  |
|   |  | <input type="checkbox"/> Level with tire       |  |

### Individual Shape

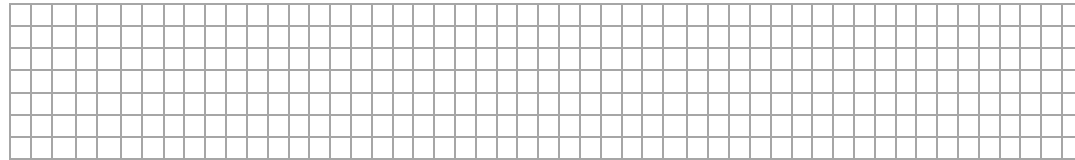

## BACKREST

### Backrest Height (Choose One)

- |   |                                 |  |  |  |
|---|---------------------------------|--|--|--|
| <input type="checkbox"/> XY230<br>Fixed backrest height |                                 | <input type="checkbox"/> XY245<br>\$248.00 | Adjustable backrest height<br><i>(+/-25mm)</i> |  |
| Specify height  | <input type="text" value="mm"/> | Specify height                             | <input type="text" value="mm"/>                |  |

### Ergonomic Options

- |  |  |  |   |  |
|--|--|--|---|--|
| <input checked="" type="checkbox"/> XY360<br>Backrest angle  |  | <input type="checkbox"/> XG100<br>\$146.00 | Ergonomic backrest                          |  |
| <input type="checkbox"/> -5 <input type="checkbox"/> -3 <input type="checkbox"/> 0 <input type="checkbox"/> +3 <input type="checkbox"/> +5 |  | Vertical height                            | <input type="text" value="mm"/>             |  |
| Individual <input type="text" value="Deg"/><br><i>(Max -10/+10 Deg)</i>  |  | Rearward position                          | <input type="text" value="mm"/>             |  |
| <input type="checkbox"/> XG110<br>\$146.00   | Inward taper<br><i>(not with ELAXY245)</i> | <input type="checkbox"/> XG120<br>\$146.00 | Outward flare<br><i>(not with ELAXY245)</i> |  |
| Specify width or per side  | <input type="text" value="mm"/>            | Specify width or per side                  | <input type="text" value="mm"/>             |  |

## CASTORS AND REAR WHEELS

### Castor Options

- |  |   |
|--|---|
| <input checked="" type="checkbox"/> XC160 Sport 61mm castor<br>(Black) | <input type="checkbox"/> XC181 Bones Reds bearings<br>(All castor bearings)                   |
| <input checked="" type="checkbox"/> XC200 Sport micro fork             | <input type="checkbox"/> XC182 Bones Swiss Ceramic bearings<br>\$601.00 (All castor bearings) |

### Rear Wheel Size

- |   |   |   |  |
|---|---|---|--|
| <input type="checkbox"/> XY420 24" Wheels | <input type="checkbox"/> XY430 25" Wheels | <input type="checkbox"/> XY440 26" Wheels | <input type="checkbox"/> XY450 700C Wheels |
|---|---|---|--|

### Rear Wheel Gap

- |   |  |
|---|--|
| <input type="checkbox"/> XY460 Rear wheel gap | <input type="checkbox"/> XY470 Inside to inside of wheel |
|---|--|

15  20  25  30

Individual

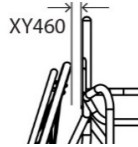

OR

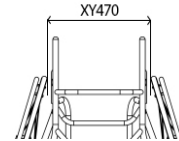

### Rear Wheel Options

- |  |   |
|--|---|
| <input type="checkbox"/> XK030 Equalizer 36/48 spoke                     | <input type="checkbox"/> XK330 Spinergy <b>SLX R10</b> heavy duty 24 spoke<br>\$1,859.00 (18 deg camber angle only) |
| <input type="checkbox"/> XK080 Spinergy <b>SLX</b> 24 spoke<br>\$1006.00 |   |

#### Spinergy Colour Options

- |  |  |  |
|--|--|--|
| <input type="checkbox"/> Black spokes  | <input type="checkbox"/> White spokes  | <input type="checkbox"/> Yellow spokes |
| <input type="checkbox"/> Red spokes    | <input type="checkbox"/> Blue spokes   | <input type="checkbox"/> Pink spokes   |
| <input type="checkbox"/> Purple spokes | <input type="checkbox"/> Orange spokes | <input type="checkbox"/> Green spokes  |

- |  |
|--|
| <input type="checkbox"/> XK180 Individual spoke design<br>\$213.00 |
|--|

Inside: \_\_\_\_\_

Outside: \_\_\_\_\_

#### Spinergy Anodize Options

- |   |  |  |   |
|---|--|--|---|
| <input type="checkbox"/> XK190 Black hub<br>NC (std option) | <input type="checkbox"/> XK200 Silver hub<br>\$127.00    | <input type="checkbox"/> XK201 Red hub/rims<br>\$409.00  | <input type="checkbox"/> XK205 Individual hub/rims<br>\$568.00 Select colour: _____ |
| <input type="checkbox"/> XK202 Purple hub/rims<br>\$409.00  | <input type="checkbox"/> XK203 Blue hub/rims<br>\$409.00 | <input type="checkbox"/> XK204 Gold hub/rims<br>\$539.00 |   |

### Supply Without Wheels

- |  |
|--|
| <input type="checkbox"/> XK040 Supply without Wheels |
|--|

 Wheel Type: 

 Tire Type: 

### Handrim Position / Options

- |   |  |
|---|--|
| <input type="checkbox"/> XY480 Narrow set handrim   | <input type="checkbox"/> XY485 Wide set handrim  |
| <input type="checkbox"/> XL090 Remove excess mounting tabs<br>\$146.00 (recommended for small wheel gaps) | <input type="checkbox"/> XL080 Super narrow set handrim<br>\$294.00 (only with XL040 and includes XL090) |

### Handrim Style

- |   |   |
|---|---|
| <input type="checkbox"/> XL010 Aluminium hard anodized 6 tab                                  | <input type="checkbox"/> XL040 Titanium 6 tab<br>\$446.00 (Not with 700C) |
| <input type="checkbox"/> XL070 Aluminium hard anodized 12 tab<br>\$146.00 (24" not available) | <input type="checkbox"/> XL050 Stainless steel 6 tab<br>\$248.00          |

### Tire Options

- |  |  |
|--|--|
| <input type="checkbox"/> XM070 Kenda Kaliente <input type="checkbox"/> Red <input type="checkbox"/> Blue | <input type="checkbox"/> XM080 Tufo MS3 tubeless (Blue only)<br>\$81.00              |
| <input type="checkbox"/> XM150 IRC Exeracer Pro (Red Only)<br>\$188.00                                   | <input type="checkbox"/> XM090 Tufo WS3 tubeless (24" only and Blue only)<br>\$81.00 |

### Spare Wheel

- |   |  |
|---|--|
| <input type="checkbox"/> ELAXK500 Spare wheel Spinergy<br>\$2,258.00 (All inclusive + axle pin) | <input type="checkbox"/> XK520 Spare wheel upcharge<br>\$634.00 (for Titanium or super narrow push rims) |
|---|--|

### Inner Tube Valve Options

- |   |  |
|---|--|
| <input type="checkbox"/> XY500 Schraeder inner tube valve | <input type="checkbox"/> XY490 Presta inner tube valve<br>(Standard if no option selected) |
|---|--|



## FINISH OPTIONS

### Frame & Component finish

<input type="checkbox"/> XN010 Powder coated frame		<input type="checkbox"/> XN150 Powder coated components <i>(Frame colour if not specified)</i>																																																																																		
<b>Gloss</b>	<b>Matt</b>	<b>Special</b>																																																																																		
<table border="0"> <tr><td><input type="checkbox"/></td><td><input type="checkbox"/></td><td>Black gloss 103</td></tr> <tr><td><input type="checkbox"/></td><td><input type="checkbox"/></td><td>White gloss 100</td></tr> <tr><td><input type="checkbox"/></td><td><input type="checkbox"/></td><td>Grey gloss 132</td></tr> <tr><td><input type="checkbox"/></td><td><input type="checkbox"/></td><td>Cream gloss 135</td></tr> <tr><td><input type="checkbox"/></td><td><input type="checkbox"/></td><td>Red gloss 108</td></tr> <tr><td><input type="checkbox"/></td><td><input type="checkbox"/></td><td>Yellow gloss 120</td></tr> <tr><td><input type="checkbox"/></td><td><input type="checkbox"/></td><td>Forest green gloss 143</td></tr> <tr><td><input type="checkbox"/></td><td><input type="checkbox"/></td><td>Green gloss 107</td></tr> <tr><td><input type="checkbox"/></td><td><input type="checkbox"/></td><td>Dark blue gloss 151</td></tr> <tr><td><input type="checkbox"/></td><td><input type="checkbox"/></td><td>Royal blue gloss 154</td></tr> <tr><td><input type="checkbox"/></td><td><input type="checkbox"/></td><td>Blue gloss 174</td></tr> <tr><td><input type="checkbox"/></td><td><input type="checkbox"/></td><td>Duckegg blue gloss 141</td></tr> <tr><td><input type="checkbox"/></td><td><input type="checkbox"/></td><td>Pink gloss 188</td></tr> <tr><td><input type="checkbox"/></td><td><input type="checkbox"/></td><td>Orange gloss 180</td></tr> <tr><td><input type="checkbox"/></td><td><input type="checkbox"/></td><td>Purple gloss 157</td></tr> </table>	<input type="checkbox"/>	<input type="checkbox"/>	Black gloss 103	<input type="checkbox"/>	<input type="checkbox"/>	White gloss 100	<input type="checkbox"/>	<input type="checkbox"/>	Grey gloss 132	<input type="checkbox"/>	<input type="checkbox"/>	Cream gloss 135	<input type="checkbox"/>	<input type="checkbox"/>	Red gloss 108	<input type="checkbox"/>	<input type="checkbox"/>	Yellow gloss 120	<input type="checkbox"/>	<input type="checkbox"/>	Forest green gloss 143	<input type="checkbox"/>	<input type="checkbox"/>	Green gloss 107	<input type="checkbox"/>	<input type="checkbox"/>	Dark blue gloss 151	<input type="checkbox"/>	<input type="checkbox"/>	Royal blue gloss 154	<input type="checkbox"/>	<input type="checkbox"/>	Blue gloss 174	<input type="checkbox"/>	<input type="checkbox"/>	Duckegg blue gloss 141	<input type="checkbox"/>	<input type="checkbox"/>	Pink gloss 188	<input type="checkbox"/>	<input type="checkbox"/>	Orange gloss 180	<input type="checkbox"/>	<input type="checkbox"/>	Purple gloss 157	<table border="0"> <tr><td><input type="checkbox"/></td><td><input type="checkbox"/></td><td>Black matt 105</td></tr> <tr><td><input type="checkbox"/></td><td><input type="checkbox"/></td><td>White matt 101</td></tr> <tr><td><input type="checkbox"/></td><td><input type="checkbox"/></td><td>Grey matt 131</td></tr> <tr><td><input type="checkbox"/></td><td><input type="checkbox"/></td><td>Light grey matt 133</td></tr> <tr><td><input type="checkbox"/></td><td><input type="checkbox"/></td><td>Navy blue matt 152</td></tr> </table>	<input type="checkbox"/>	<input type="checkbox"/>	Black matt 105	<input type="checkbox"/>	<input type="checkbox"/>	White matt 101	<input type="checkbox"/>	<input type="checkbox"/>	Grey matt 131	<input type="checkbox"/>	<input type="checkbox"/>	Light grey matt 133	<input type="checkbox"/>	<input type="checkbox"/>	Navy blue matt 152	<table border="0"> <tr><td><input type="checkbox"/></td><td><input type="checkbox"/></td><td>Chrome Mirror 300</td></tr> <tr><td><input type="checkbox"/></td><td><input type="checkbox"/></td><td>Sparkle silver 170</td></tr> <tr><td><input type="checkbox"/></td><td><input type="checkbox"/></td><td>Metallic black matt 104</td></tr> <tr><td><input type="checkbox"/></td><td><input type="checkbox"/></td><td>Metallic grey matt 130</td></tr> <tr><td><input type="checkbox"/></td><td><input type="checkbox"/></td><td>Black sandpaper 201</td></tr> <tr><td><input type="checkbox"/></td><td><input type="checkbox"/></td><td>Grey sandpaper 202</td></tr> <tr><td><input type="checkbox"/></td><td><input type="checkbox"/></td><td>White sandpaper 200</td></tr> </table>		<input type="checkbox"/>	<input type="checkbox"/>	Chrome Mirror 300	<input type="checkbox"/>	<input type="checkbox"/>	Sparkle silver 170	<input type="checkbox"/>	<input type="checkbox"/>	Metallic black matt 104	<input type="checkbox"/>	<input type="checkbox"/>	Metallic grey matt 130	<input type="checkbox"/>	<input type="checkbox"/>	Black sandpaper 201	<input type="checkbox"/>	<input type="checkbox"/>	Grey sandpaper 202	<input type="checkbox"/>	<input type="checkbox"/>	White sandpaper 200
<input type="checkbox"/>	<input type="checkbox"/>	Black gloss 103																																																																																		
<input type="checkbox"/>	<input type="checkbox"/>	White gloss 100																																																																																		
<input type="checkbox"/>	<input type="checkbox"/>	Grey gloss 132																																																																																		
<input type="checkbox"/>	<input type="checkbox"/>	Cream gloss 135																																																																																		
<input type="checkbox"/>	<input type="checkbox"/>	Red gloss 108																																																																																		
<input type="checkbox"/>	<input type="checkbox"/>	Yellow gloss 120																																																																																		
<input type="checkbox"/>	<input type="checkbox"/>	Forest green gloss 143																																																																																		
<input type="checkbox"/>	<input type="checkbox"/>	Green gloss 107																																																																																		
<input type="checkbox"/>	<input type="checkbox"/>	Dark blue gloss 151																																																																																		
<input type="checkbox"/>	<input type="checkbox"/>	Royal blue gloss 154																																																																																		
<input type="checkbox"/>	<input type="checkbox"/>	Blue gloss 174																																																																																		
<input type="checkbox"/>	<input type="checkbox"/>	Duckegg blue gloss 141																																																																																		
<input type="checkbox"/>	<input type="checkbox"/>	Pink gloss 188																																																																																		
<input type="checkbox"/>	<input type="checkbox"/>	Orange gloss 180																																																																																		
<input type="checkbox"/>	<input type="checkbox"/>	Purple gloss 157																																																																																		
<input type="checkbox"/>	<input type="checkbox"/>	Black matt 105																																																																																		
<input type="checkbox"/>	<input type="checkbox"/>	White matt 101																																																																																		
<input type="checkbox"/>	<input type="checkbox"/>	Grey matt 131																																																																																		
<input type="checkbox"/>	<input type="checkbox"/>	Light grey matt 133																																																																																		
<input type="checkbox"/>	<input type="checkbox"/>	Navy blue matt 152																																																																																		
<input type="checkbox"/>	<input type="checkbox"/>	Chrome Mirror 300																																																																																		
<input type="checkbox"/>	<input type="checkbox"/>	Sparkle silver 170																																																																																		
<input type="checkbox"/>	<input type="checkbox"/>	Metallic black matt 104																																																																																		
<input type="checkbox"/>	<input type="checkbox"/>	Metallic grey matt 130																																																																																		
<input type="checkbox"/>	<input type="checkbox"/>	Black sandpaper 201																																																																																		
<input type="checkbox"/>	<input type="checkbox"/>	Grey sandpaper 202																																																																																		
<input type="checkbox"/>	<input type="checkbox"/>	White sandpaper 200																																																																																		
<input type="checkbox"/> ELAXN030 Brushed frame \$565.00 <i>(All parts black unless XN160 chosen)</i>		<input type="checkbox"/> XN160 Brushed components \$121.00 <i>(not required with fixed footrest &amp; backrest)</i>																																																																																		
<input type="checkbox"/> ELAXN050 Polished frame \$665.00 <i>(All parts black unless XN170 chosen)</i>		<input type="checkbox"/> XN170 Polished components \$213.00 <i>(not required with fixed footrest &amp; backrest)</i>																																																																																		
<input type="checkbox"/> RGK-XN200 Individual paint colour (State Colour/RAL code) \$565.00																																																																																				
<table border="0"> <tr><td>Frame</td><td>Comp</td></tr> <tr><td><input type="checkbox"/></td><td><input type="checkbox"/></td></tr> </table>				Frame	Comp	<input type="checkbox"/>	<input type="checkbox"/>																																																																													
Frame	Comp																																																																																			
<input type="checkbox"/>	<input type="checkbox"/>																																																																																			

### Accent Colour

**Note:** Accent colour includes, forks, castor caps, decals.

<input type="checkbox"/> Black accent	<input type="checkbox"/> Silver accent	<input type="checkbox"/> RGK-XN250 Individual accent \$315.00
<input type="checkbox"/> Red accent	<input type="checkbox"/> Blue accent	<input style="width: 100px; height: 20px;" type="text" value="Select Colour:"/>
<input type="checkbox"/> Purple accent		

## UPHOLSTERY (N/A WITH CX SEAT)

### Seat Upholstery

XP040 Seat sling strap adjustable  
*(Not required with seat plate)*

### Backrest Upholstery

<input checked="" type="checkbox"/> XP055 Airtex sport backrest strap adjustable (BLK)	<input type="checkbox"/> XP070 Backrest upgrade to leather corners \$121.00 <i>(Black)</i>
--	--

### Backrest Stitching Options

<input type="checkbox"/> Silver	<input type="checkbox"/> Black	<input type="checkbox"/> Blue	<input type="checkbox"/> Individual: _____
<input type="checkbox"/> Red	<input type="checkbox"/> Light blue	<input type="checkbox"/> Purple	

### Backrest RGK Logo Colour

<input type="checkbox"/> White (Std)	<input type="checkbox"/> Green	<input type="checkbox"/> Blue	<input type="checkbox"/> Individual: _____
<input type="checkbox"/> Red	<input type="checkbox"/> Light blue	<input type="checkbox"/> Purple	

### Backrest Accessories

XP170 Individual backrest embroidery  
\$240.00  
*(Please provide .jpeg file an positioning)*



CUSHION		
Cushion Foam Options		
<input type="checkbox"/> <b>XP080</b> \$121.00 Cushion foam <i>(select density and size below)</i>	<input type="checkbox"/> Soft (CMS040) <input type="checkbox"/> Medium (CMS050) <input type="checkbox"/> Hard (9lb recon) <input type="checkbox"/> 50mm <input type="checkbox"/> 75mm <input type="checkbox"/> 100mm <input type="checkbox"/> Other <input style="width: 80px;" type="text"/> mm	
<input type="checkbox"/> <b>XP340</b> \$115.00 Plastazote cushion upgrade <i>(Indicate max height)</i>		
Cushion Cover Options		
<input type="checkbox"/> <b>XP081</b> Nylon cushion cover      (Black)		
<input type="checkbox"/> <b>XP090</b> \$98.00 Air Lite cushion cover      (Black)	<input type="checkbox"/> <b>XP380</b> \$127.00 Neoprene cushion cover      (Black)	
STRAPS		
Velcro straps		
<input type="checkbox"/> <b>XS050</b> \$173.00 100mm Pro adjustable velcro strap	<input type="checkbox"/> <b>XS020</b> \$140.00 Sport ratchet strap (Click strap) <i>(11" x 2" pad)</i>	
<input type="checkbox"/> <b>XS055</b> \$135.00 50mm Pro adjustable velcro strap	<input type="checkbox"/> <b>XS025</b> \$406.00 Pelvi Loc 2DA ratchet strap <i>(For thighs and knees)</i>	
<input type="checkbox"/> <b>XS057</b> \$250.00 50mm Pro knee strap <i>(measurement from tube to tube over knees)</i>	Select size: <input type="checkbox"/> Medium (8") <input type="checkbox"/> Large (10")	
Velcro strap position		
<input type="checkbox"/> <b>Strap 1</b> <input style="width: 100px;" type="text"/> Type		
 Specify strap length <input style="width: 80px;" type="text"/> mm	 Specify distance from back post <input style="width: 80px;" type="text"/> mm	
<input type="checkbox"/> <b>Strap 1</b> <input style="width: 100px;" type="text"/> Type		
 Specify strap length <input style="width: 80px;" type="text"/> mm	 Specify distance from back post <input style="width: 80px;" type="text"/> mm	
<input type="checkbox"/> <b>XS030</b> \$419.00 Pelvi Loc 3DA ratchet strap <i>(For hips)</i>		
Select size: <input type="checkbox"/> Small (8") <input type="checkbox"/> Medium (9") <input type="checkbox"/> Large (10") <input type="checkbox"/> Extra Large (11")		
<input type="checkbox"/> <b>XS035</b> \$283.00 M2 ratchet strap <i>(For thighs and knees)</i>		
Select size: <input type="checkbox"/> 8" <input type="checkbox"/> 10" <input type="checkbox"/> 12"		
<input type="checkbox"/> <b>Strap 1</b> <input style="width: 100px;" type="text"/> Type		
 Specify distance from back post <input style="width: 80px;" type="text"/> mm	<input type="checkbox"/> <b>Strap 2</b> <input style="width: 100px;" type="text"/> Type	
 Specify distance from back post <input style="width: 80px;" type="text"/> mm		
<input type="checkbox"/> <b>XS040</b> \$160.00 Fixed mounting points <i>(one set per click strap)</i>		
<input type="checkbox"/> x1 <input type="checkbox"/> x2 <input type="checkbox"/> x3		
<input type="checkbox"/> <b>XS045</b> \$96.00 Clamped mounting points <i>(one set per click strap)</i>		
<input type="checkbox"/> x1 <input type="checkbox"/> x2 <input type="checkbox"/> x3		
FRAME OPTIONS		
<input type="checkbox"/> <b>XR060</b> \$154.00 Calf strap mounting loops		
<input type="checkbox"/> <b>XR065</b> \$118.00 Strap location loops		
ACCESSORIES		
<input type="checkbox"/> <b>XR030</b> \$201.00 Triple wheel bag      (Black)	<input type="checkbox"/> <b>XS070</b> Foot strap <i>(select if required)</i>	
<input type="checkbox"/> <b>XP130</b> \$127.00 Frame protectors full length	<input type="checkbox"/> <b>XS060</b> Calf strap <i>(select if required)</i>	
<input type="checkbox"/> <b>XS100</b> \$103.00 Bodypoint waist strap	<input type="checkbox"/> Small <input type="checkbox"/> Large	
<input type="checkbox"/> <b>XP400</b> Back bar protector		
<input type="checkbox"/> <b>XR090</b> Tool kit		

**ELITE**

SERIAL NO: \_\_\_\_\_

PROD DATE: \_\_\_\_ / \_\_\_\_

