



# JAY<sup>®</sup> Zip Pediatric Backrest



July 2018

**Mark For:** \_\_\_\_\_

**Submitting for:**  Quote  Order

Date: \_\_\_\_\_

PO#: \_\_\_\_\_

Dealer Acct #: \_\_\_\_\_

Dealer: \_\_\_\_\_

**ADDITIONAL SHIPPING INFORMATION**

Dealer Contact: \_\_\_\_\_

Ship To: \_\_\_\_\_

Dealer Address: \_\_\_\_\_

Attention: \_\_\_\_\_

Dealer City: \_\_\_\_\_ PV: \_\_\_\_\_ PC: \_\_\_\_\_

Address: \_\_\_\_\_

Dealer Phone: ( ) \_\_\_\_\_ Fax: ( ) \_\_\_\_\_

Address: \_\_\_\_\_

Confirmation Email: \_\_\_\_\_

Ship To City: \_\_\_\_\_ PV: \_\_\_\_\_ PC: \_\_\_\_\_

Confirm Via:  Fax  Email

Ship To Phone: ( ) \_\_\_\_\_ Fax: ( ) \_\_\_\_\_

✓ Option #                      Definition                      Price                      ✓ Option #                      Definition                      Price

**JAY ZIP BACK**

<input type="checkbox"/>	JZIPBXXY	JAY Zip Backrest All Sizes	\$948.00
NOTE: Select appropriate assembly number below.			
165 lbs Weight Capacity			

- EACH BACK SHIPS WITH THE FOLLOWING:**
- Ultra lightweight mounting hardware
  - 1.6" of anterior depth adjustment, 3" with reversing hardware provided
  - 10mm Combo Wrench
  - Angle Adjustability from -20° to +20°
  - Neoprene Backrest Hardware Covers (Allows for quick release)
  - Water resistant inner cover & Anti-microbial outer cover
  - Adjustable lumbar support



	8"	10"	12"	14"
BACKREST WIDTH	8"	10"	12"	14"
FITS BACK CANE WIDTHS	8"-9"	10"-11"	12"-13"	14"-15"
MAX. USER TRUNK WIDTH	7"	9"	11"	13"
ACTUAL SHELL WIDTH	5.6"	7.6"	9.6"	11.6"
DEPTH OF CONTOUR	1"	1.5"	2"	2.5"

**NEW!**

		Backrest Width			
		8"	10"	12"	14"
Backrest Height	 6" (S)	<input type="checkbox"/> JZIPB08S	<input type="checkbox"/> JZIPB10S	<input type="checkbox"/> JZIPB12S	<input type="checkbox"/> JZIPB14S
	 8" (M)	<input type="checkbox"/> JZIPB08M	<input type="checkbox"/> JZIPB10M	<input type="checkbox"/> JZIPB12M	<input type="checkbox"/> JZIPB14M
	 10" (T)	<input type="checkbox"/> JZIPB08T	<input type="checkbox"/> JZIPB10T	<input type="checkbox"/> JZIPB12T	<input type="checkbox"/> JZIPB14T
	 12" (X)	<input type="checkbox"/> JZIPB08X	<input type="checkbox"/> JZIPB10X	<input type="checkbox"/> JZIPB12X	<input type="checkbox"/> JZIPB14X

The JAY ZIP Backrest has been dynamically tested and meets all criteria for use in motor vehicles according to Section 5.1 of ISO 16840-4 and Section 20, ANSI/RESNA WC/Volume 4.  
Please visit [www.sunparts.ca](http://www.sunparts.ca) for spare parts information.

**JAY ZIP BACK ACCESSORIES**

JAY ZIP Back accessories are optional. All accessories will be factory mounted as much as possible to insure proper shipping.

**LATERAL SUPPORTS**

Use this section for lateral supports.

**FIXED LATERAL THORACIC SUPPORT**

Includes fixed mounting hardware.

<input type="checkbox"/>	JZFX34F	LAT ZIP FIXED 3X4 FLAT	\$313.00	<input type="checkbox"/>	JZFX34C	LAT ZIP FIXED 3X4 CURVE	\$313.00
<input type="checkbox"/>	JZFX45F	LAT ZIP FIXED 4X5 FLAT	\$313.00	<input type="checkbox"/>	JZFX45C	LAT ZIP FIXED 4X5 CURVE	\$313.00

**SWING-AWAY LATERAL THORACIC SUPPORT**

Includes swing-away mounting hardware and all laterals are sold in pairs.

<input type="checkbox"/>	<b>JZSA34F</b>	<b>LAT 3X4 FLAT W/ S/A MOUNT</b>	<b>\$624.00</b>	<input type="checkbox"/>	<b>JZSA34CO</b>	<b>LAT 3X4 CRV 1" OFF W/ S/A MNT</b>	<b>\$624.00</b>
	JZ34F	LAT ZIP 3X4 FLAT			JZ34CO	LAT 3X4 CURVE W/ 1" OFFSET	
	JZSAMNT	LATERAL SWING AWAY MOUNT			JZSAMNT	LATERAL SWING AWAY MOUNT	
<input type="checkbox"/>	<b>JZSA45F</b>	<b>LAT 4X5 FLAT W/ S/A MOUNT</b>	<b>\$624.00</b>	<input type="checkbox"/>	<b>JZSA45CO</b>	<b>LAT 4X5 CRV 1" OFF W/ S/A MNT</b>	<b>\$624.00</b>
	JZ45F	LAT ZIP 4X5 FLAT			JZ45CO	LAT 4X5 CURVE W/ 1IN OFFSET	
	JZSAMNT	LATERAL SWING AWAY MOUNT			JZSAMNT	LATERAL SWING AWAY MOUNT	
<input type="checkbox"/>	<b>JZSA34C</b>	<b>LAT 3X4 CURVE W/ S/A MOUNT</b>	<b>\$624.00</b>	<input type="checkbox"/>	<b>JZSA34FOA</b>	<b>LAT 3X4 FLAT ADJ 1" OFF W/ S/A</b>	<b>\$624.00</b>
	JZ34C	LAT ZIP 3X4 CURVE			JZ34FOA	LAT 3X4 FLAT W/ ADJ 1" OFFSET	
	JZSAMNT	LATERAL SWING AWAY MOUNT			JZSAMNT	LATERAL SWING AWAY MOUNT	
<input type="checkbox"/>	<b>JZSA45C</b>	<b>LAT 4X5 CURVE W/ S/A MOUNT</b>	<b>\$624.00</b>	<input type="checkbox"/>	<b>JZSA45FOA</b>	<b>LAT 4X5 FLAT ADJ 1" OFF W/ S/A</b>	<b>\$624.00</b>
	JZ45C	LAT ZIP 4X5 CURVE			JZ45FOA	LAT 4X5 FLAT W/ ADJ 1" OFFSET	
	JZSAMNT	LATERAL SWING AWAY MOUNT			JZSAMNT	LATERAL SWING AWAY MOUNT	
<input type="checkbox"/>	<b>JZSA34FO</b>	<b>LAT 3X4 FLT 1" OFF W/ S/A MNT</b>	<b>\$624.00</b>	<input type="checkbox"/>	<b>JZSA34COA</b>	<b>LAT 3X4 CRV ADJ 1" OFF W/ S/A</b>	<b>\$624.00</b>
	JZ34FO	LAT ZIP 3X4 FLAT W/ 1" OFFSET			JZ34COA	LAT 3X4 CRV W/ ADJ 1" OFFSET	
	JZSAMNT	LATERAL SWING AWAY MOUNT			JZSAMNT	LATERAL SWING AWAY MOUNT	
<input type="checkbox"/>	<b>JZSA45FO</b>	<b>LAT 4X5 FLT 1" OFF W/ S/A MNT</b>	<b>\$624.00</b>	<input type="checkbox"/>	<b>JZSA45COA</b>	<b>LAT 4X5 CRV ADJ 1" OFF W/ S/A</b>	<b>\$624.00</b>
	JZ45FO	LAT ZIP 4X5 FLAT W/ 1" OFFSET			JZ45COA	LAT 4X5 CRV W/ ADJ 1" OFFSET	
	JZSAMNT	LATERAL SWING AWAY MOUNT			JZSAMNT	LATERAL SWING AWAY MOUNT	

**LATERAL MEASURING GUIDE (Fixed and Swing Away)**

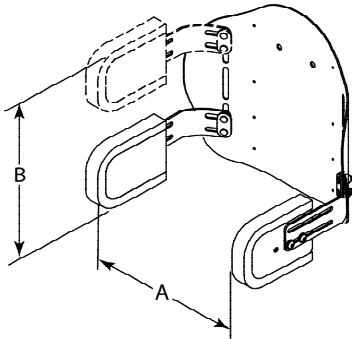

DIM	Description	Back Width			
		8" Wide	10" Wide	12" Wide	14" Wide
A	<b>Lateral Adjustment Range</b> (Min Spacing - Max Spacing)	3.8" - 4.8"	5.1" - 6.1"	6.8" - 7.8"	8.4" - 9.4"
B	<b>Lateral Height Range</b> (Measured from bottom edge of shell to top of lateral)	6" Tall Back	Not Available		
		8" Tall Back	7"		
		10" Tall Back	9"		
		12" Tall Back	10"		

**HEADRESTS**

<input type="checkbox"/>	<b>JZHED6</b>	<b>Headrest w/ Pad - 6" Plush</b>	<b>\$464.00</b>
	JPLSH06	Pad - 6" Plush	
	JZIPBHH	ONYX post w/ Axy's Hardware	
<input type="checkbox"/>	<b>JZHED8</b>	<b>Headrest w/ Pad - 8" Plush</b>	<b>\$464.00</b>
	JPLSH08	Pad - 8" Plush	
	JZIPBHH	ONYX post w/ Axy's Hardware	
<input type="checkbox"/>	<b>JZHEDCINF</b>	<b>Headrest w/ Pad - 6" Contoured</b>	<b>\$428.00</b>
	JCNTR06	Pad - 6" Contoured Cradle	
	JZIPBHH	ONYX post w/ Axy's Hardware	
<input type="checkbox"/>	<b>JZHEDCS</b>	<b>Headrest w/ Pad - 8" Contoured</b>	<b>\$442.00</b>
	JCNTR08	Pad - 8" Contoured Cradle	
	JZIPBHH	ONYX post w/ Axy's Hardware	

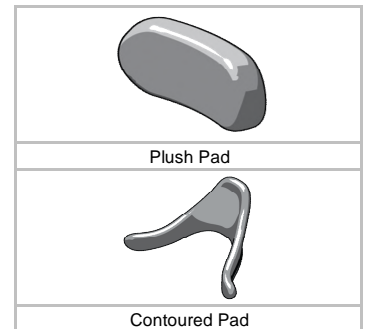
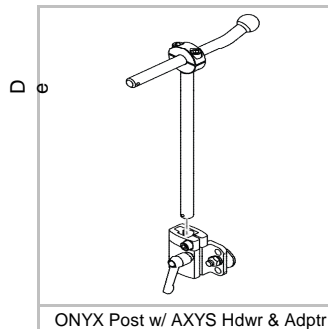







**VANITY FLAP**

Vanity flaps are NOT INCLUDED as a standard option with the JAY ZIP Back.

<input type="checkbox"/>	VF08	8" to 9" Wide	\$83.00	<input type="checkbox"/>	VF12	12" to 13" Wide	\$83.00
<input type="checkbox"/>	VF10	10" to 11" Wide	\$83.00	<input type="checkbox"/>	VF14	14" to 15" Wide	\$83.00

**SPINE ALIGN POSITIONING COMPONENTS**

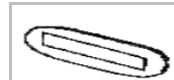
<input type="checkbox"/>	J3SPNCR	Curved Shim	\$34.00	<input type="checkbox"/>	J3SPNBL	Large Bean Bag	\$39.00
<input type="checkbox"/>	J3SPNBS	Small Bean Bag	\$39.00	<input type="checkbox"/>	J3SPNLS	Lateral Shim	\$62.00
<input type="checkbox"/>	J3SPNFL	Flat Shim	\$34.00	<input type="checkbox"/>	J3SPNLP	Posterior/Lateral Pelvic	\$62.00

						
	<b>Curved Slim</b>	<b>Flat</b>	<b>Lateral Slim</b>	<b>Sm Bean Bag</b>	<b>Lg Bean Bag</b>	<b>Post/Lat Pelvic</b>
<b>W</b>	10"	10"	2.4"	6"	10"	5.3"
<b>H</b>	4"	4"	4.3"	4.5"	3.2"	3.6"
<b>D</b>	0.5"	0.3"	0.5"	0.75"	0.75"	0.75"

**CHEST STRAPS & HARNESES**

*Chest Straps & Harnesses include guide brackets and hardware.*

<input type="checkbox"/>	JZ9407	Center Opening w/ Buckle (EI)	\$222.00	<input type="checkbox"/>	JZ9107	Contoured - Dynamic Pull Down (EI)	\$222.00
<input type="checkbox"/>	JZ9400	Center Opening w/ Buckle (XS)	\$222.00	<input type="checkbox"/>	JZ9100	Contoured - Dynamic Pull Down(XS)	\$222.00
<input type="checkbox"/>	JZ9401	Center Opening w/ Buckle (S)	\$222.00	<input type="checkbox"/>	JZ9101	Contoured - Dynamic Pull Down (S)	\$222.00
<input type="checkbox"/>	JZ9402	Center Opening w/ Buckle (M)	\$222.00	<input type="checkbox"/>	JZ9102	Contoured - Dynamic Pull Down (M)	\$222.00
<input type="checkbox"/>	JZ8107	Classic - Dynamic Pull Down (EI)	\$222.00	<input type="checkbox"/>	JZ9300	Contoured - Structrd Pull Down (XS)	\$222.00
<input type="checkbox"/>	JZ8100	Classic - Dynamic Pull Down (XS)	\$222.00	<input type="checkbox"/>	JZ9301	Contoured - Structrd Pull Down (S)	\$222.00
<input type="checkbox"/>	JZ8101	Classic - Dynamic Pull Down (S)	\$222.00	<input type="checkbox"/>	JZ9302	Contoured - Structrd Pull Down (M)	\$222.00
<input type="checkbox"/>	JZ8102	Classic - Dynamic Pull Down (M)	\$222.00	<input type="checkbox"/>	JZ4050	Padded Anterior Trunk Straps (XS)	\$222.00
<input type="checkbox"/>	JZ8300	Classic - Structured Pull Down (XS)	\$222.00	<input type="checkbox"/>	JZ4000	Padded Anterior Trunk Straps (S)	\$222.00
<input type="checkbox"/>	JZ8301	Classic - Structured Pull Down (S)	\$222.00	<input type="checkbox"/>	JZ4100	Padded Anterior Trunk Straps (M)	\$222.00
<input type="checkbox"/>	JZ8302	Classic - Structured Pull Down (M)	\$222.00				

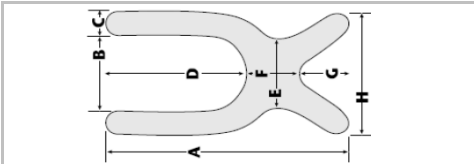
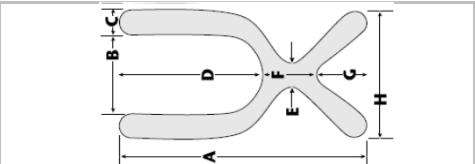
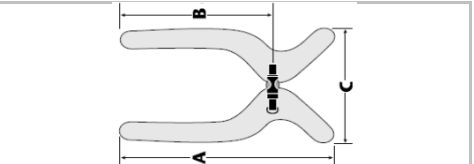
																																																																																																																
Classic Style	Contour Style	Center-Opening with Buckle																																																																																																														
<table border="1"> <thead> <tr> <th></th> <th>A</th> <th>B</th> <th>C</th> <th>D</th> <th>E</th> <th>F</th> <th>G</th> <th>H</th> </tr> </thead> <tbody> <tr> <td>EI</td> <td>9.8"</td> <td>3"</td> <td>2"</td> <td>5.3"</td> <td>3"</td> <td>3"</td> <td>1"</td> <td>6.5"</td> </tr> <tr> <td>XS</td> <td>12.5"</td> <td>3.5"</td> <td>2"</td> <td>7.5"</td> <td>3.5"</td> <td>3"</td> <td>2"</td> <td>7.5"</td> </tr> <tr> <td>S</td> <td>15"</td> <td>4.5"</td> <td>2"</td> <td>9"</td> <td>4"</td> <td>4"</td> <td>2"</td> <td>8.5"</td> </tr> <tr> <td>M</td> <td>19"</td> <td>5.5"</td> <td>2"</td> <td>11"</td> <td>5"</td> <td>5"</td> <td>3"</td> <td>9.5"</td> </tr> </tbody> </table>		A	B	C	D	E	F	G	H	EI	9.8"	3"	2"	5.3"	3"	3"	1"	6.5"	XS	12.5"	3.5"	2"	7.5"	3.5"	3"	2"	7.5"	S	15"	4.5"	2"	9"	4"	4"	2"	8.5"	M	19"	5.5"	2"	11"	5"	5"	3"	9.5"	<table border="1"> <thead> <tr> <th></th> <th>A</th> <th>B</th> <th>C</th> <th>D</th> <th>E</th> <th>F</th> <th>G</th> <th>H</th> </tr> </thead> <tbody> <tr> <td>EI</td> <td>9.8"</td> <td>3"</td> <td>1.8"</td> <td>5.3"</td> <td>1"</td> <td>3.5"</td> <td>1.5"</td> <td>6.5"</td> </tr> <tr> <td>XS</td> <td>12.5"</td> <td>3.5"</td> <td>2"</td> <td>7.5"</td> <td>1"</td> <td>3.5"</td> <td>1.5"</td> <td>7.5"</td> </tr> <tr> <td>S</td> <td>15"</td> <td>4.5"</td> <td>2"</td> <td>9"</td> <td>1"</td> <td>4"</td> <td>2"</td> <td>8.5"</td> </tr> <tr> <td>M</td> <td>18.5"</td> <td>5.5"</td> <td>2"</td> <td>11"</td> <td>1"</td> <td>5"</td> <td>2.5"</td> <td>9.5"</td> </tr> </tbody> </table>		A	B	C	D	E	F	G	H	EI	9.8"	3"	1.8"	5.3"	1"	3.5"	1.5"	6.5"	XS	12.5"	3.5"	2"	7.5"	1"	3.5"	1.5"	7.5"	S	15"	4.5"	2"	9"	1"	4"	2"	8.5"	M	18.5"	5.5"	2"	11"	1"	5"	2.5"	9.5"	<table border="1"> <thead> <tr> <th></th> <th>A</th> <th>B</th> <th>C</th> </tr> </thead> <tbody> <tr> <td>EI</td> <td>9.8"</td> <td>7"</td> <td>5"</td> </tr> <tr> <td>XS</td> <td>11"</td> <td>8"</td> <td>5.8"</td> </tr> <tr> <td>S</td> <td>12.3"</td> <td>9"</td> <td>6.5"</td> </tr> <tr> <td>M</td> <td>14.3"</td> <td>11"</td> <td>9.8"</td> </tr> </tbody> </table>		A	B	C	EI	9.8"	7"	5"	XS	11"	8"	5.8"	S	12.3"	9"	6.5"	M	14.3"	11"	9.8"
	A	B	C	D	E	F	G	H																																																																																																								
EI	9.8"	3"	2"	5.3"	3"	3"	1"	6.5"																																																																																																								
XS	12.5"	3.5"	2"	7.5"	3.5"	3"	2"	7.5"																																																																																																								
S	15"	4.5"	2"	9"	4"	4"	2"	8.5"																																																																																																								
M	19"	5.5"	2"	11"	5"	5"	3"	9.5"																																																																																																								
	A	B	C	D	E	F	G	H																																																																																																								
EI	9.8"	3"	1.8"	5.3"	1"	3.5"	1.5"	6.5"																																																																																																								
XS	12.5"	3.5"	2"	7.5"	1"	3.5"	1.5"	7.5"																																																																																																								
S	15"	4.5"	2"	9"	1"	4"	2"	8.5"																																																																																																								
M	18.5"	5.5"	2"	11"	1"	5"	2.5"	9.5"																																																																																																								
	A	B	C																																																																																																													
EI	9.8"	7"	5"																																																																																																													
XS	11"	8"	5.8"																																																																																																													
S	12.3"	9"	6.5"																																																																																																													
M	14.3"	11"	9.8"																																																																																																													

**JAY YOUR WAY MODIFICATIONS**

*Note: To order options offered via JAY Your Way add an "M" to the front of the part number and follow the prompts.*

*For additional modifications visit [www.sunrisemedical.ca](http://www.sunrisemedical.ca) to view even more!*

<b>COVER COLOR OPTIONS - Rear Center Flap</b>			
<input type="checkbox"/>	COCP1	Pink Semi Stretch Cover	NC
<input type="checkbox"/>	COCB	Blue Semi Stretch Cover	NC
<input type="checkbox"/>	COCPU	Purple Cover	NC
<input type="checkbox"/>	COCR	Red Cover	NC
<input type="checkbox"/>	COCB	Toxic Green Cover	NC

<b>COLOR BACK SHELLS <span style="border: 1px solid black; padding: 2px;">NEW!</span></b>			
<i>Paint your Zip back shell to match any of the Zippie or Quickie Frame Colors!</i>			
<input type="checkbox"/>	XXCBS	Zippie/Quickie Back Shell Paint	NC
Write Desired Back Shell Color Here:			

