



Distributor Name: \_\_\_\_\_

Contact Name: \_\_\_\_\_

Address: \_\_\_\_\_

Postcode: \_\_\_\_\_

Country: \_\_\_\_\_

Telephone: \_\_\_\_\_

Email: \_\_\_\_\_

Dealers Name: \_\_\_\_\_

Client's Name: \_\_\_\_\_

Client's Weight: \_\_\_\_\_

Client's Height: \_\_\_\_\_

Client's Disability: \_\_\_\_\_

Purchase Order No: \_\_\_\_\_

Delivery Address: \_\_\_\_\_

Postcode: \_\_\_\_\_

Contact Name: \_\_\_\_\_

Telephone: \_\_\_\_\_

Email: \_\_\_\_\_

Notes/Comments:

Do Not Use for Specification Information

**FOR RGK OFFICE USE ONLY**

Distributor: \_\_\_\_\_

A/C No: \_\_\_\_\_

Net Value: \$ \_\_\_\_\_

Freight: \$ \_\_\_\_\_

Invoice Value: \$ \_\_\_\_\_

Payment Received: \$ \_\_\_\_\_

	Who	Date
OK to Quote:		
OK to Confirm:		
Document No:	DOC	

- |  |  |   |
|--|--|---|
| <input checked="" type="checkbox"/> Base Product           | <input type="checkbox"/> Mandatory Information     | <input checked="" type="checkbox"/> Information Required for Option |
| <input checked="" type="checkbox"/> Standard Configuration | <input type="checkbox"/> Option with No extra cost | <input type="checkbox"/> Option with Extra cost                     |

FXAXZ010 TIGA FX A7020  
\$ 6,130.00





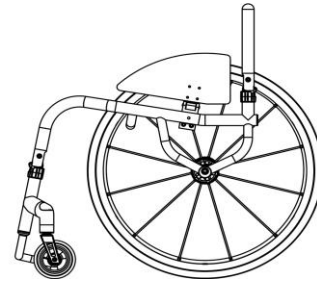

XA070 Frame open design

Max User Weight 125kg

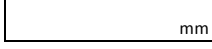
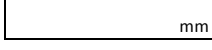

XW010  
NC

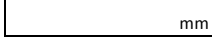
### KEY FRAME MEASUREMENTS

- |   |  |  |  |
|---|--|--|--|
| <input checked="" type="checkbox"/> XY010 | Seat width <i>(Inside of sideguards)</i>   | <input type="checkbox"/> Mandatory Information   | <input type="checkbox"/> Information Required for Option |
|   |  mm   | (Max - 460mm)  | (Min - 250mm)  |
| <input checked="" type="checkbox"/> XY020 | Seat length  | <input type="checkbox"/> Mandatory Information   | <input type="checkbox"/> Information Required for Option |
|   |  mm   | (Max - 460mm)  | (Min - 250mm)  |
| <input type="checkbox"/> XY030            | Seat frame additional length <i>(Provides additional leg support &amp; hand grip)</i>  | <input checked="" type="checkbox"/> Information Required for Option                    |  |
|   |  mm |  |  |
| <input checked="" type="checkbox"/> XY050 | Front frame height   | <input type="checkbox"/> Mandatory Information   | <input type="checkbox"/> Information Required for Option |
|   |  mm | (Max - 550mm)  | (Min - 480mm)  |
| <input checked="" type="checkbox"/> XY060 | Rear frame height  | <input type="checkbox"/> Mandatory Information   | <input type="checkbox"/> Information Required for Option |
|   |  mm | (Max - 550mm)  | (Min - 360mm)  |
| <input checked="" type="checkbox"/> XY070 | Frame length   | <input type="checkbox"/> Mandatory Information   | <input type="checkbox"/> Information Required for Option |
|   |  mm | (Min XY020 + XY030 + 110mm)  |  |
| <input type="checkbox"/> XA020            | Frame ergonomic seat   | <input checked="" type="checkbox"/> Information Required for Option                    |  |
|   | \$ 93.00   |  |  |
|   | Specify length   |  mm | (Standard = 120mm)                                       |

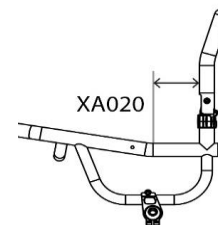
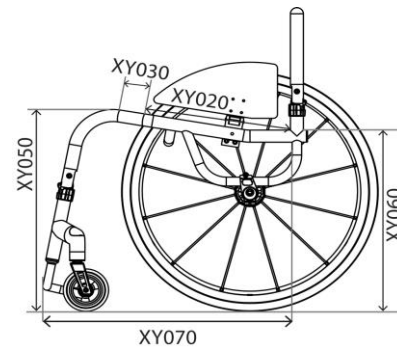
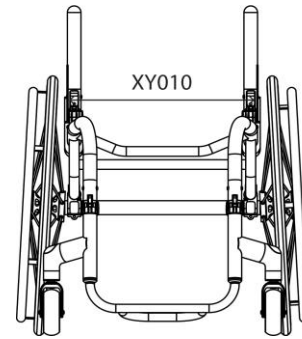

## FRONT FRAME AND FOOTREST

### Front Frame Options

XY080 Front seat taper design

Specify width

\_\_\_\_\_ mm

Optimise measurements (XY010 - 100mm)

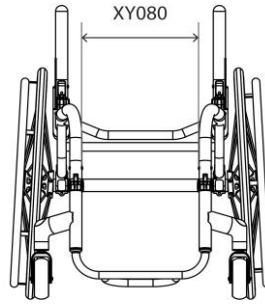

### Footrest Design & Measurements (Choose One)

XY100 Footrest round design (Minimum 60mm)

Please indicate front footrest height:

60  80  100  120

Individual \_\_\_\_\_ mm

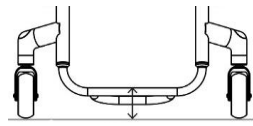

Castor Wheel Size	Max Height Achievable	With XB200
3"	115mm	165mm
4"	125mm	175mm
5"	135mm	185mm

XB200 Footrest with high level riser system (Only with \$ 155.00 FXAXB110)

XY105 Footrest square design (Square design allows higher position) (Minimum 60mm)

Please indicate front footrest height:

60  80  100  120

Individual \_\_\_\_\_ mm

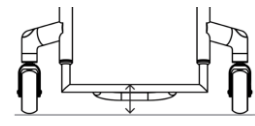

Castor Wheel Size	Max Height Achievable	With XB200
3"	135mm	185mm
4"	145mm	195mm
5"	155mm	205mm

XB200 Footrest with high level riser system (Only with \$ 155.00 FXAXB110)

### Footrest Individual Measurements

Rear footrest height

\_\_\_\_\_ mm

Optimise measurements (Std = Footrest height - 20mm)

Footrest length

\_\_\_\_\_ mm

Optimise measurements (Std = 100mm)

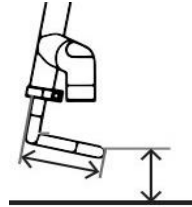

### Footrest Style and Cover (Choose One)

FXAXB110 Footrest fixed position welded into frame with carbon plate (Supplied with spacer kit to give 20mm upward adjustment)

XB160 Footrest grip tape fitted to any footrest cover \$ 41.00

FXAXB120 Footrest clamp-on height and angle adjustable aluminium plate

## CASTOR WHEELS, FORKS & WHEEL LOCKS

### Castor Wheels

3"

- XC150 Castor wheel 3x1.4" aluminium centre frog legs (Silver hub and black urethane tyre)  
\$ 180.00

4"

- XC060 Castor wheel 4x1.3" soft roll black
- XC110 Castor wheel 4x1" aluminium centre frog legs (Silver hub & black urethane tyre)  
\$ 180.00
- XC130 Castor wheel 4x1.4" aluminium centre with urethane tyre frog legs  
\$ 180.00 Choose colour below (XC130 Only) :

Choose one castor option only

- |  |  |  |   |
|--|--|--|---|
| <input type="checkbox"/> Silver hub & black tyre (Std) | <input type="checkbox"/> Black hub & blue tyre | <input type="checkbox"/> Purple hub & black tyre | <input type="checkbox"/> Silver hub & blue tyre |
| <input type="checkbox"/> Black hub & black tyre        | <input type="checkbox"/> Red hub & black tyre  | <input type="checkbox"/> Gold hub & black tyre   | <input type="checkbox"/> Silver hub & red tyre  |
| <input type="checkbox"/> Black hub & red tyre          | <input type="checkbox"/> Blue hub & black tyre | <input type="checkbox"/> Green hub & black tyre  |   |

5"

- XC070 Castor wheel 5x1.3" soft roll black
- XC100 Castor wheel 5" pneumatic aluminium centre  
\$ 191.00
- XC120 Castor wheel 5x1" aluminium centre frog legs (Silver hub & black urethane tyre)  
\$ 180.00
- XC140 Castor wheel 5x1.4" aluminium centre frog legs (Silver hub & black urethane tyre)  
\$ 180.00

### Castor Forks

- |  |   |  |
|--|---|--|
| <input type="checkbox"/> XC190 Castor fork low ride daily use (Standard when no option selected) | <input type="radio"/> XC210 Castor fork suspension frog legs<br>\$ 489.00 | <input type="radio"/> XC220 Castor fork single sided untine frog legs<br>\$ 191.00 |
| <input type="checkbox"/> Black <input type="checkbox"/> Silver                                   | <input type="checkbox"/> Black <input type="checkbox"/> Silver            | <input type="checkbox"/> Black <input type="checkbox"/> Silver                     |

### Castor Pin Width

- XY330 Castor pin width (XY010 plus 70mm)

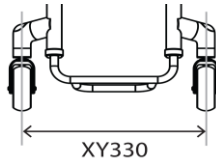

### Wheel Lock Options

#### Scissor

- XD020 Wheel locks underseat scissor
- XD040 Wheel locks scissor levers drilled  
\$ 57.00
- XD030 Wheel locks compact scissor  
\$ 206.00
- XD035 Wheel locks compact scissor with lightweight fixing  
\$ 273.00 (Only with fixed centre of gravity)

#### Other

- XD050 Wheel locks push to lock
- XD010 Wheel locks omit

## SIDEGUARDS AND ARMRESTS

Sideguard		Sideguard with Fender	
Aluminium Options		Aluminium Options	
<input type="radio"/>	XE080 Sideguards lift out aluminium \$ 412.00	<input type="radio"/>	XE090 Sideguards lift out aluminium with fender \$ 448.00
<input type="radio"/>	FXAXE130 Sideguards fold flat aluminium \$ 380.00	<input type="radio"/>	FXAXE140 Sideguards fold flat aluminium with fender \$ 422.00
Carbon Fibre Options		Carbon Fibre Options	
<input type="radio"/>	XE100 Sideguards lift out carbon fibre \$ 592.00	<input type="radio"/>	XE110 Sideguards lift out carbon fibre with fender \$ 876.00
<input type="radio"/>	FXAXE150 Sideguards fold flat carbon fibre \$ 633.00	<input type="radio"/>	FXAXE160 Sideguards fold flat carbon fibre with fender \$ 773.00
ABS Plastic Options		Sideguard Measurements	
<input type="radio"/>	XE120 Sideguards lift out ABS plastic \$ 376.00	Optimised measurements	
<input type="radio"/>	FXAXE170 Sideguards fold flat ABS plastic \$ 380.00	Fender sideguard height above tyre (Min = 10mm) <div style="display: flex; align-items: center;"> <input type="checkbox"/> <input style="width: 100px; height: 20px; border: 1px solid black;" type="text"/> mm                     </div> <input type="checkbox"/> Optimise (10mm above tyre)	
Armrest Options		Individual measurements	
<input type="radio"/>	XF010 Armrest fixed height, lift out with plastic sideguard \$ 458.00 (Indicate height)	<input type="checkbox"/>	Fender sideguard to centre of tyre  (Standard if no option selected)
<input type="radio"/>	XF020 Armrest fixed height, lift out with aluminium sideguard \$ 361.00 (Indicate height)	<input type="checkbox"/>	Fender sideguard to outside of tyre
<input type="checkbox"/> Height (Top of seatrail to top of armrest) <div style="display: flex; align-items: center;"> <input type="checkbox"/> <input style="width: 100px; height: 20px; border: 1px solid black;" type="text"/> mm                     </div>		 	
Sideguard Measurements		Choose optimised or individual measurements	
Optimised measurements			
Individual measurements			
Choose optimised or individual measurements	<input type="checkbox"/> Sideguard 25mm above tyre (Follow tyre - Std if not indicated)		
	<input type="checkbox"/> Sideguard individual above tyre (Follow tyre)		
	<input type="checkbox"/> Sideguard level with tyre (Follow tyre)		
	<input type="checkbox"/> Sideguard individual level with tyre		
Sideguard length			
<input style="width: 100px; height: 20px; border: 1px solid black;" type="text"/> mm			
Sideguard height			
<input style="width: 100px; height: 20px; border: 1px solid black;" type="text"/> mm			

Serial Number: \_\_\_\_\_

Manufacturing Date: \_\_\_\_\_/20\_\_\_\_



## BACKREST

### Backrest Height - Fixed or Adjustable (Choose One)

Backrest height fixed  
(Maximum 400mm)  
Specify height

mm

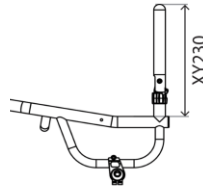

XY245 Backrest height adjustable  
\$ 191.00  
(Maximum 400mm)  
(Upward range 50mm)

Indicate lowest height  
 mm

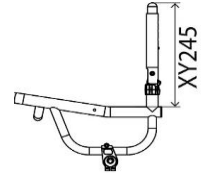

### Backrest Design - Fixed or Folding (Choose One)



FXAXG060 Backrest folding with Q Lock

### Ergonomics - Rearward Positioning (Choose One)

XY360 Backrest angle



-5  -3  0  +3  +5

Individual  Deg  
(Max -7/+7 Deg)

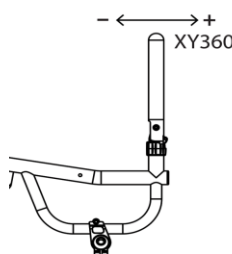



XG100 Backrest ergonomic  
\$ 113.00  
Vertical height (Min 250mm)

mm

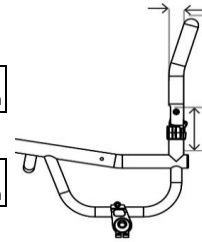

Rearward position  
 mm



### Ergonomics - Lateral Positioning (Choose One)

XG110 Backrest inward taper  
\$ 113.00  
(Above sideguards)

Width  mm

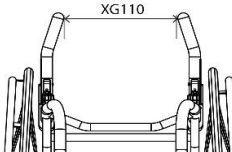

XG120 Backrest outward flare  
\$ 113.00  
(Above sideguards)

Width  mm

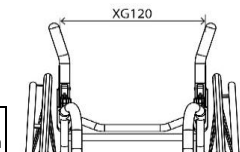

### Push handle Options

XG070 Backrest with screw in push handles (N/A with XY245)  
\$ 175.00

XG080 Backrest with flip down push handles (N/A with XY245)  
\$ 340.00

XG085 Backrest with flip down push handles height adjustable (N/A with XY245)  
\$ 556.00



<b>CAMBER BAR</b>	
<p style="text-align: center; background-color: #eee; margin-bottom: 5px;"><b>Adjustable Centre of Gravity</b></p> <div style="display: flex; justify-content: space-between;"> <div style="width: 45%;"> <p><input type="checkbox"/> XH110 Camber bar adjustable position square back frame (25-150mm) (Max seat width 500mm)</p> <p> <input style="width: 100px;" type="text"/> mm</p> <p></p> <p style="text-align: center; font-size: small;">XH110</p> </div> <div style="width: 45%;"> <p><input type="checkbox"/> XH120 Centre of gravity adjustable round back frame (60-150mm)</p> <p> <input style="width: 100px;" type="text"/> mm</p> <p></p> <p style="text-align: center; font-size: small;">XH120</p> </div> </div>	<p style="text-align: center; background-color: #eee; margin-bottom: 5px;"><b>Fixed Centre of Gravity</b></p> <div style="display: flex; justify-content: space-between;"> <div style="width: 45%;"> <p><input type="radio"/> FXAXH090 Camber bar fixed position integrated into frame V design (25-125mm)</p> <p> <input style="width: 100px;" type="text"/> mm</p> <p style="text-align: center; font-size: small;">FXAXH090</p> </div> <div style="width: 45%;"> </div> </div>
<p style="text-align: center; background-color: #eee; margin-bottom: 5px;"><b>Specify Camber Angle</b></p> <p><input checked="" type="checkbox"/> XY390 Camber angle</p> <p> <input type="checkbox"/> 0 <input type="checkbox"/> 1 <input type="checkbox"/> 2 <input type="checkbox"/> 3 <input type="checkbox"/> 5</p>	<p style="text-align: center; background-color: #eee; margin-bottom: 5px;"><b>Specify Camber Angle</b></p> <p><input checked="" type="checkbox"/> XY390 Camber angle</p> <p> <input type="checkbox"/> 0 <input type="checkbox"/> 1 <input type="checkbox"/> 2 <input type="checkbox"/> 3 <input type="checkbox"/> 5</p>
<p style="text-align: center; background-color: #eee; margin-bottom: 5px;"><b>Camber Bar Options</b></p> <p><input type="radio"/> XH030 Suspension camber bar frog legs \$ 659.00</p> <p><input type="radio"/> XH040 Handbike camber bar fixed welded \$ 309.00</p> <p style="margin-left: 20px;">Camber angle (<i>Handbike camber bar</i>)</p> <p> <input type="checkbox"/> 0 <input type="checkbox"/> 5</p> <p style="margin-left: 20px;">Castor height from floor for handbike fitting (Standard 30mm if not indicated)</p> <p> <input type="checkbox"/> 30 <input type="checkbox"/> 50</p>	<p style="text-align: center; background-color: #eee; margin-bottom: 5px;"><b>Camber Bar Options</b></p> <p><input type="radio"/> XH040 Handbike camber bar fixed welded \$ 309.00</p> <p style="margin-left: 20px;">Camber angle (<i>Handbike camber bar</i>)</p> <p> <input type="checkbox"/> 0 <input type="checkbox"/> 5</p> <p style="margin-left: 20px;">Castor height from floor for handbike fitting (Standard 30mm if not indicated)</p> <p> <input type="checkbox"/> 30 <input type="checkbox"/> 50</p>
<b>Anti-Tip Options</b>	
<p><input type="radio"/> XJ010 Anti tip swingaway left side (Only with square back frame. Not with XH040) \$ 129.00</p>	<p><input type="radio"/> XJ020 Anti tip swingaway right side (Only with square back frame. Not with XH040) \$ 129.00</p>



REAR WHEELS											
Wheel Size											
<input type="checkbox"/> XY420 Wheel size 24"	<input type="checkbox"/> XY430 Wheel size 25"	<input type="checkbox"/> XY440 Wheel size 26"									
Wheel Gap											
<input type="checkbox"/> XY460 Rear wheel gap <input type="checkbox"/> 15 <input type="checkbox"/> 20 <input type="checkbox"/> 25 <div style="border: 1px solid black; width: 100px; height: 20px; margin-top: 5px;"></div> <div style="text-align: right; font-size: 8px;">mm</div>											
Wheel Options (Choose one)											
<input type="checkbox"/> XK010 Wheel Sun Fusion 16 spoke daily use <input type="radio"/> XK050 Wheel Spinerger LX 12 spoke daily use \$ 773.00 (select colour below) <input type="radio"/> XK210 Wheel Topolino carbon core with red accents \$ 1,545.00 (24", 25" only)	<input type="radio"/> XK320 Wheel Spinerger XLX 12 spoke cross spoked \$ 824.00 daily (select colour below) <input type="radio"/> XK060 Wheel Spinerger SPOX 18 spoke daily (select colour below) \$ 515.00 <input type="radio"/> XK070 Wheel Spinerger BLXL 18 blade spoke daily, rivnut handrim mounting (select colour below - <b>Note:</b> Black hub only) \$ 824.00										
<div style="display: flex; justify-content: space-between;"> <div style="width: 45%;"> <p><b>i</b> <b>Spinerger Colour Options</b></p> <table style="width: 100%; border: none;"> <tr> <td><input type="checkbox"/> Black spoke / Silver hub</td> <td><input type="checkbox"/> White spoke / Black Hub</td> </tr> <tr> <td><input type="checkbox"/> Red spoke / Black hub</td> <td><input type="checkbox"/> Blue spoke / Black hub</td> </tr> <tr> <td><input type="checkbox"/> Yellow spoke / Black hub</td> <td><input type="checkbox"/> Green spoke / Black hub</td> </tr> <tr> <td><input type="checkbox"/> Pink spoke / Black hub</td> <td><input type="checkbox"/> Orange spoke / black hub</td> </tr> </table> </div> <div style="width: 45%;"> <p><input type="radio"/> XK180 Spinerger spoke colour custom \$ 165.00 (Specify below)</p> <div style="border: 1px solid black; padding: 2px; margin-bottom: 5px;"> <p><b>i</b> Colour inside</p> </div> <div style="border: 1px solid black; padding: 2px;"> <p>Colour outside</p> </div> <p><i>Note: Supply picture for custom designs</i></p> </div> </div>				<input type="checkbox"/> Black spoke / Silver hub	<input type="checkbox"/> White spoke / Black Hub	<input type="checkbox"/> Red spoke / Black hub	<input type="checkbox"/> Blue spoke / Black hub	<input type="checkbox"/> Yellow spoke / Black hub	<input type="checkbox"/> Green spoke / Black hub	<input type="checkbox"/> Pink spoke / Black hub	<input type="checkbox"/> Orange spoke / black hub
<input type="checkbox"/> Black spoke / Silver hub	<input type="checkbox"/> White spoke / Black Hub										
<input type="checkbox"/> Red spoke / Black hub	<input type="checkbox"/> Blue spoke / Black hub										
<input type="checkbox"/> Yellow spoke / Black hub	<input type="checkbox"/> Green spoke / Black hub										
<input type="checkbox"/> Pink spoke / Black hub	<input type="checkbox"/> Orange spoke / black hub										

FRAME FINISH OPTIONS		
Frame	Components	
<input type="checkbox"/> XN010 Finish frame powder coated <i>(Includes H-frame)</i>  <input type="checkbox"/> Specify Code <input style="width: 100px; height: 20px;" type="text"/>  <input type="radio"/> FXAXN030 Finish frame brushed aluminium \$ 165.00  <input type="radio"/> FXAXN050 Finish frame polished aluminium \$ 515.00	<input type="checkbox"/> XN150 Finish components powder coated <i>(Camber bar &amp; sideguards) (Standard black if not Indicated)</i>  <input type="checkbox"/> Specify Code <input style="width: 100px; height: 20px;" type="text"/>  <input type="radio"/> XN160 Finish components brushed \$ 93.00 <i>(Camber bar &amp; sideguards)</i>  <input type="radio"/> XN170 Finish components polished \$ 165.00 <i>(Camber bar &amp; sideguards)</i>	
Accent Colour (Choose One)		
<input type="checkbox"/> Finish accent colour black  <input type="checkbox"/> Finish accent colour red  <input type="checkbox"/> Finish accent colour purple	<input type="checkbox"/> Finish accent colour silver  <input type="checkbox"/> Finish accent colour blue	
UPHOLSTERY		
Seat Upholstery		
<input type="checkbox"/> XP040 Upholstery seat sling adjustable tension with straps <i>(Standard if not indicated)</i>	<input type="radio"/> XR050 Accessory carbon fibre seat plate in lieu of seat upholstery \$ 371.00	
Backrest Upholstery		
<input type="checkbox"/> XP050 Upholstery backrest Airtech adjustable tension with straps <i>(Standard if not indicated)</i>		
Backrest Upholstery Leather Options		
<input type="radio"/> XP060 Upholstery backrest upgrade to full leather \$ 386.00		
<input type="checkbox"/> Leather colour black <i>(Standard if not indicated)</i>	<input type="checkbox"/> Leather colour red	<input type="checkbox"/> Leather colour grey
<input type="radio"/> XP070 Upholstery upgrade to leather corners on side wings - <i>(N/A with XG080)</i> \$ 93.00		
<input type="checkbox"/> Leather colour black <i>(Standard if not indicated)</i>	<input type="checkbox"/> Leather colour red	<input type="checkbox"/> Leather colour grey
Backrest Upholstery Stitching Options		
<input type="checkbox"/> Silver (Standard if not indicated)	<input type="checkbox"/> Black	<input type="checkbox"/> Blue
<input type="checkbox"/> Red	<input type="checkbox"/> Light blue	<input type="checkbox"/> Purple
Backrest Upholstery Logo Options		
<input type="checkbox"/> Silver (Standard if not)	<input type="checkbox"/> Black	<input type="checkbox"/> Blue
<input type="checkbox"/> Red	<input type="checkbox"/> Light blue	<input type="checkbox"/> Purple
Backrest Accessories		
<input type="radio"/> XP110 Upholstery backrest with zip fasten pocket \$ 98.00	<input type="radio"/> XP170 Upholstery with individual embroidery \$ 155.00 <i>(please provide .jpeg file and positioning)</i>	

## CUSHION

- XP080 Upholstery cushion foam with nylon cover  
\$ 93.00
-   Cushion foam soft (CMS040)       Cushion foam medium (CMS050)       Cushion foam hard (9lb recon)
- Cushion thickness 50mm       Cushion thickness 75mm       Cushion thickness 100mm
- XP090 Upholstery cushion cover upgrade to Air Lite  
\$ 77.00
- XP100 Upholstery cushion cover upgrade to leather  
\$ 196.00
-   Leather colour black       Leather colour red       Leather colour grey

## FRAME OPTIONS

- XR080 Accessory front wheel assembly  
\$ 814.00
- Frontwheel serial number  
 (Office use only)

## ACCESSORIES

- XR010 Accessory seat pouch velcro attach  
\$ 46.00 (Black standard)
- XR100 Accessory FX carry bag  
\$ 258.00
- XR090 Accessory toolkit
- XS060 Accessory calf strap

