



July 01, 2015

ACCOUNT #: _____ SHIP TO: _____
 DATE: _____ NAME: _____
 P.O. #: _____ ADDRESS: _____
 CITY: _____ PROVINCE: _____
 POSTAL CODE: _____ PHONE #: _____
 BUYER: _____ MARKED FOR: _____



Product Info ▶

CLIENT MEASUREMENTS

First Name	
Age	
Diagnosis	
Height	
Weight	
1. Top of Head to Seat	
2. Top of Shoulder to Seat*	
3. Under Arm to Seat	
4. Trunk Depth	
5. Actual Sitting Depth*	
6. Foot Length	
7. Width of Head	
8. Shoulder Width	
9. Chest Width	
10. Hip Width*	
11. Left Lower Leg Length*	
12. Right Lower Leg Length*	

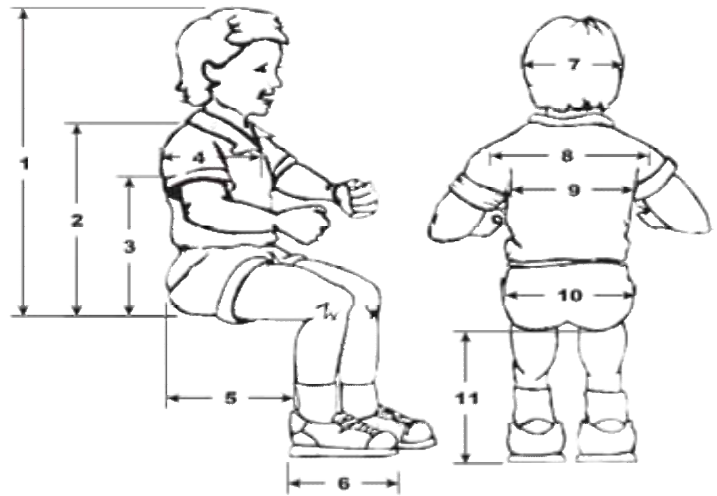

Client Wheelchair Description

Model	
Back Height	
Custom Embroidery (12 Ltr Limit)	
<input type="checkbox"/> Name	
Style	<input type="checkbox"/> Script/Cursive
	<input type="checkbox"/> Block/Uppercase <input type="checkbox"/> Block/Lowercase
Stock Monogram Design	
<input type="checkbox"/> Color	
T-Nut Locaiton	<input type="checkbox"/> Do Not Mark 0677Z01
Combine with Wheelchair	<input type="checkbox"/> See Quickie/Zippie OF 0677Z01
	<input type="checkbox"/> Existing Chair Serial # 067XL03
Chair Width	
Seat Rail Diameter	<input type="checkbox"/> 7/8" 067XZ01
	<input type="checkbox"/> 1" 067XZ02
Chair Depth	
Upper Back Cane Diameter	<input type="checkbox"/> 3/4" 067XL03
	<input type="checkbox"/> 7/8" 067XL01
	<input type="checkbox"/> 1" 067XL02
	<input type="checkbox"/> 1 1/8" 067XL03
Lower Back Cane Diameter	<input type="checkbox"/> 7/8" 067XQ02
	<input type="checkbox"/> 1" 067XQ01
	<input type="checkbox"/> 1 1/8" 067XQ03

Seating Specifications

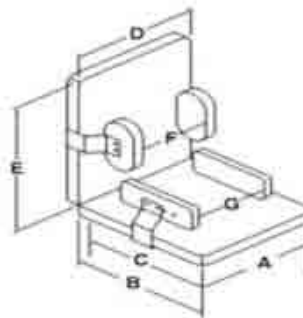

A. Seat Width	
B. Seat Depth (Total)	
C. Seat Depth (Usable)	
D. Back Width	
E. Back Height	
F. Width Between Laterals	
G. Width Between Hips	

Notes

NOTE: REQUIRED SELECTIONS ONLY WHEN ORDERING A BACK

BACK

5. BACK STYLE - REQUIRED

Standard Planar

- \$260 Up to 13"w
 - \$321 Over 13"w
 - Omit
- A* _____

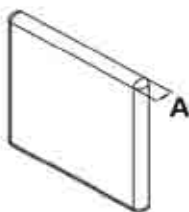

* Foam Thickness Only

6. BACK MODIFICATION - OPTIONAL

Curved Foam

- Add \$326
- A* _____
B _____
C _____

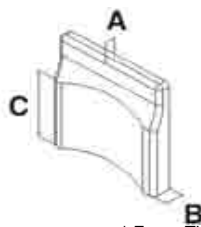

* Foam Thickness Only

I-Back Modification

- NC
- A* _____
B _____
C _____
D _____

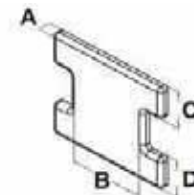

6. BACK MODIFICATION (CONTINUED) - OPTIONAL

***T-Back Modification**

- Add \$179
- A* _____
B _____
C _____

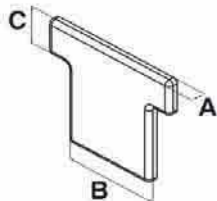

* N/A w/ Quicke TS snap 2 or 4 pin
* Foam Thickness Only

***Biangular Modification**

- Add \$296
- A* _____
B _____
C _____

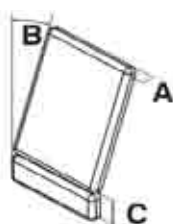

Grid Back

- Add \$520
- A* _____
B _____
C _____

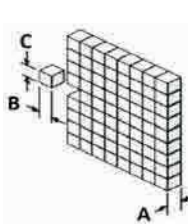

* Foam Thickness Only

Lumbar with Straps

- Add \$199
- A* _____
B _____
C _____

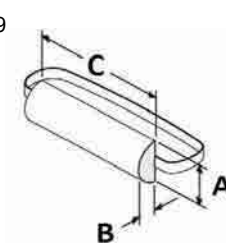

Note: Modifications retail is added to the price of the Planar Back

<input type="checkbox"/>	067YS11	Curved Wood Back	\$350.00
--------------------------	---------	------------------	----------

NEW!

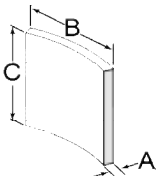

A* _____
* Foam Thickness Only
B _____
C _____

<input type="checkbox"/>	067YS12	Adjustable Lumbar Support	\$365.00
--------------------------	---------	---------------------------	----------

NEW!

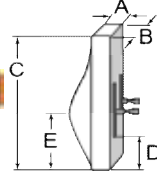

A* _____
* Foam Thickness Only
B _____
C _____
D _____
E _____

7. COVER OPTIONS - REQUIRED

<input type="checkbox"/>	Standard Zipper Access Cover	N/C
--------------------------	------------------------------	-----

8. UPHOLSTERY - REQUIRED

	Contact Surface	Non-Contact Surface
Rubutex (Black Only)	<input type="checkbox"/>	<input type="checkbox"/>
Naughyde	<input type="checkbox"/>	<input type="checkbox"/>
Color _____		Color _____
Dartex	<input type="checkbox"/>	<input type="checkbox"/>
Reverse Dartex	<input type="checkbox"/>	<input type="checkbox"/>

10. BACK HARDWARE - REQUIRED

See pictures of hardware options to the right w/ seat to back bracket w/o bracket

<input type="checkbox"/>	Quickie TS Snap 2 pin	\$150.00 kit	<input type="checkbox"/>	\$245 kit
<input type="checkbox"/>	Adjustable J&L	\$110.00 kit	<input type="checkbox"/>	\$220 kit
<input type="checkbox"/>	Jay 3 Back Style Short	N/A	<input type="checkbox"/>	\$325 kit
<input type="checkbox"/>	Jay 3 Back Style Long	N/A	<input type="checkbox"/>	\$325 kit
<input type="checkbox"/>	Universal Transit Hardware**	\$240.00 kit	<input type="checkbox"/>	\$480 kit
<input type="checkbox"/>	Omit Back Hardware			
<input type="checkbox"/>	NEW! Adjustable J&L (J-6 Hole & L-2 Hole)			
<input type="checkbox"/>	NEW! Adjustable J&L (Std) w/ Shurlock Rel/Fixed			
<input type="checkbox"/>	NEW! Adjustable J&L (Std) w/ Shurlock Release			

** Transit approved hardware

11. SEAT TO BACK HARDWARE - OPTIONAL

<input type="checkbox"/>	Bracket STD Flush	\$105 ea
<input type="checkbox"/>	Bracket Adjustable Wide	\$295 ea

9. FOAM - REQUIRED

<input type="checkbox"/>	HR Foam	\$26 per 1/2"
	Density	<input type="checkbox"/> 50 <input type="checkbox"/> 70
<input type="checkbox"/>	Sunmate	\$61 per 1/2"
	Density	<input type="checkbox"/> S <input type="checkbox"/> M <input type="checkbox"/> F
<input type="checkbox"/>	Omit Foam	N/C
<input type="checkbox"/>	Incontinent Wrap	N/C

9. FOAM LAYER QUANTITY - REQUIRED

Enter quantities in 1/2" increments

	Top	Middle	Bottom
HR Foam			
Sunmate			

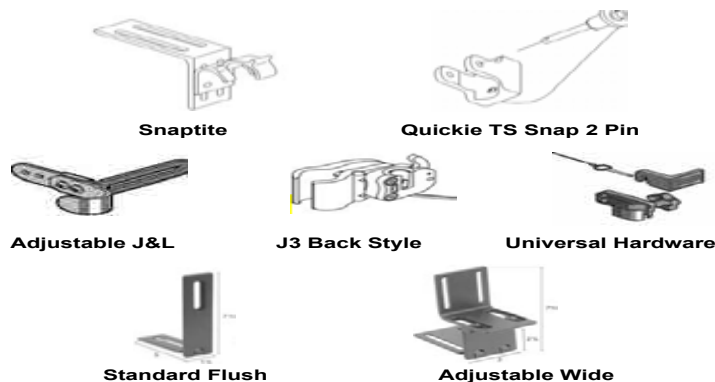

NOTE: REQUIRED SELECTIONS ONLY WHEN ORDERING A SEAT

SEAT

12. SEAT STYLE - REQUIRED

Standard Planar

- \$255 Up to 13"w
- \$310 Over 13"w
- Omit

A* _____

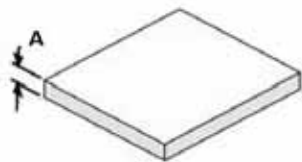

* Foam Thickness Only

13. SEAT MODIFICATION - OPTIONAL

Asymmetrical Seat

- Add \$175
- A* _____
- B _____
- C _____
- Long Side _____
- Right _____
- Left _____

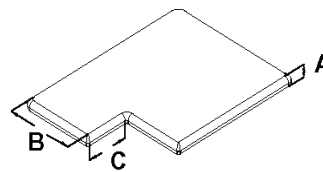

* Foam Thickness Only

13. SEAT MODIFICATION (CONTINUED) - OPTIONAL

Anti-thrust Modification

- Add \$312
- A* _____
- B _____
- C _____
- D _____

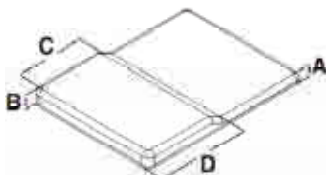

* Foam Thickness Only

Contour Seat

- Add \$416
- A* _____
- B _____
- C _____
- D _____
- E _____

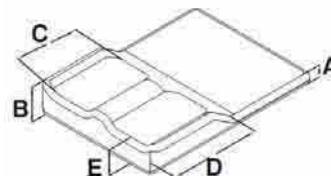

* Foam Thickness Only

14. COVER OPTIONS - REQUIRED

- Standard Zipper Access Cover N/C
- Sew Velcro Attaching Strips \$35

15. GROWTH NOTCHES - OPTIONAL

- 2" x 2" Growth tail notch N/C
- 2" x 3" Growth tail notch N/C

16. UPHOLSTERY - REQUIRED

	Contact Surface	Non-Contact Surface
Rubatex (Black Only)	<input type="checkbox"/>	<input type="checkbox"/>
Naugahyde	<input type="checkbox"/>	<input type="checkbox"/>
Color _____		Color _____
Dartex	<input type="checkbox"/>	<input type="checkbox"/>
Reverse Dartex	<input type="checkbox"/>	<input type="checkbox"/>

18. SEAT HARDWARE

See pictures of hardware options to the right w/ seat to back bracket w/o bracket

- Adjustable J&L \$110.00 kit \$220 kit
- Universal Transit Hardware Standard** \$240.00 kit \$480 kit
- Universal Transit Hardware Space Saver** \$240.00 kit \$480 kit
- Omit Seat Hardware

** Transit approved hardware
Space saver hardware will be used with any seat under 14"

CUSHIONS (OPTIONAL) (Enter Width x Depth)

- JAY Fusion w/ JAY FLOW Fluid Insert JFUSION _____ \$875
- JAY Fusion w/ ROHO Dry Flotation Single Valve Insert JFUSION _____ AS \$875
- JAY Fusion w/ ROHO Dry Flotation Dual Valve Insert JFUSION _____ AD \$890
- JAY Union Cushion JU _____ \$640
- JAY Zip Cushion JZ _____ \$595

17. FOAM - REQUIRED

- HR Foam \$25 per 1/2" Density 50 70
- Sunmate \$60 per 1/2" Density S M F
- Omit Foam N/C
- Incontinent Wrap N/C

17. FOAM LAYER QUANTITY - REQUIRED

Enter Quantities in 1/2" Increments

	Top	Middle	Bottom
HR Foam			
Sunmate			

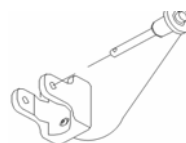

Quickie TS Snap 2 Pin

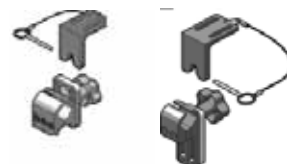

Universal hardware Standard Space Saver



Snaptite



Adjustable J&L

HEAD SUPPORT - OPTIONAL

19. PAD STYLE

- 8" Plush \$208
- 10" Plush \$215
- 14" Plush \$215
- 19" Plush \$300
- Standard Adjust-a-Plush \$325
- Narrow Adjust-a-Plush \$325
- Small Contour Cradle \$170
- Med Contour Cradle \$188
- Large Contour Cradle \$195

19. PAD COVER

- Lycra N/C
- Reverse Dartex N/C

19. MOUNTING SYSTEM

- ONYX Detachable Bracket \$227
- ONYX Detachable w/ offset vertical bar \$235
- AXYS Detachable Bracket \$330

20. MOUNTING PLATE

- Universal Mounting Plate \$110
- Swing Away Plate \$70

NOTE: When choosing head support must select Pad, Cover, and Mounting System.

21. LATERAL THORACIC SUPPORTS*

BRACKET STYLE - REQUIRED	
<input type="checkbox"/> Fixed	\$130 pr
<input type="checkbox"/> Swing Away	\$520 pr
BRACKET OFFSET - REQUIRED	
<input type="checkbox"/> Flush	N/C
<input type="checkbox"/> 1" Offset	N/C
<input type="checkbox"/> 2" Offset	N/C
BRACKET PROFILE - REQUIRED W/ FIXED BRACKETS ONLY	
<input type="checkbox"/> Standard-1"	N/C
<input type="checkbox"/> Medium-2"	N/C
<input type="checkbox"/> High-3"	N/C
ADDITIONAL HARDWARE - OPTIONAL	
<input type="checkbox"/> Quick Adjust Hardware (summer/winter)	\$295 pr

PAD SIZE - REQUIRED	
<input type="checkbox"/> 3" H x 4" L	\$165 pr
<input type="checkbox"/> 4" H x 5" L	\$165 pr
<input type="checkbox"/> 4" H x 6" L	\$165 pr
<input type="checkbox"/> 5" H x 6" L	\$165 pr
<input type="checkbox"/> Custom Size	\$225 pr
Height _____ Length _____ *Thickness _____ <input type="checkbox"/> Foam thickness only	\$415 pr
PAD STYLE - REQUIRED	
<input type="checkbox"/> Flat D	N/C
<input type="checkbox"/> Curved D	N/C
SPACERS - OPTIONAL	
<input type="checkbox"/> 1/2"-Per side	\$40
<input type="checkbox"/> 1"-Per side	\$80
<input type="checkbox"/> 1 1/2"-Per side	\$117
<input type="checkbox"/> 2"-Per side	\$155

22. LATERAL PELVIC SUPPORTS**

BRACKET STYLE - REQUIRED	
<input type="checkbox"/> Fixed	\$130 pr
<input type="checkbox"/> Removable	\$520 pr
BRACKET OFFSET - REQUIRED	
<input type="checkbox"/> Flush	N/C
<input type="checkbox"/> 1" Offset	N/C
<input type="checkbox"/> 2" Offset	N/C
BRACKET PROFILE - REQUIRED W/ FIXED BRACKETS ONLY	
<input type="checkbox"/> Standard-1"	N/C
<input type="checkbox"/> Medium-2"	N/C
<input type="checkbox"/> High-3"	N/C

PAD SIZE - REQUIRED	
<input type="checkbox"/> 3" H x 4" L	\$170 pr
<input type="checkbox"/> 4" H x 5" L	\$170 pr
<input type="checkbox"/> 4" H x 6" L	\$170 pr
<input type="checkbox"/> 5" H x 6" L	\$170 pr
<input type="checkbox"/> Custom Size	\$235 pr
Height _____ Length _____ *Thickness _____ <input type="checkbox"/> Custom Contour to Seat (Optional)	\$415 pr
SPACERS - OPTIONAL	
<input type="checkbox"/> 1/2"	\$40
<input type="checkbox"/> 1"	\$80
<input type="checkbox"/> 1 1/2"	\$117
<input type="checkbox"/> " 2	\$155

23. LATERAL THIGH SUPPORTS**

BRACKET STYLE - REQUIRED	
<input type="checkbox"/> Fixed	\$130 pr
<input type="checkbox"/> Removable	\$676 pr
BRACKET OFFSET - REQUIRED	
<input type="checkbox"/> Flush	N/C
<input type="checkbox"/> 1" Offset	N/C
<input type="checkbox"/> 2" Offset	N/C
BRACKET PROFILE - REQUIRED W/ FIXED BRACKETS ONLY	
<input type="checkbox"/> Standard-1"	N/C
<input type="checkbox"/> Medium-2"	N/C
<input type="checkbox"/> High-3"	N/C

PAD SIZE - REQUIRED	
<input type="checkbox"/> 3" H x 4" L	\$170 pr
<input type="checkbox"/> 4" H x 5" L	\$170 pr
<input type="checkbox"/> 4" H x 6" L	\$170 pr
<input type="checkbox"/> 5" H x 6" L	\$170 pr
<input type="checkbox"/> Custom Size	\$235 pr
Height _____ Length _____ *Thickness _____ <input type="checkbox"/> Custom Contour to Seat (Optional)	\$415 pr
SPACERS - OPTIONAL	
<input type="checkbox"/> 1/2"	\$40
<input type="checkbox"/> 1"	\$80
<input type="checkbox"/> 1 1/2"	\$115
<input type="checkbox"/> 2"	\$155

24. MEDIAL THIGH ABDUCTOR**

BRACKET STYLE - REQUIRED	
<input type="checkbox"/> Push Button Flip Down Bracket	\$320
PAD STYLE - REQUIRED	
<input type="checkbox"/> Oval	N/C
<input type="checkbox"/> Wedge	N/C
PAD SIZE - REQUIRED	
<input type="checkbox"/> Small	\$220
<input type="checkbox"/> Med	\$220
<input type="checkbox"/> Large	\$220

OVAL (Optional)	WEDGE (Required)
A- Height _____	A-Height _____
B- Length _____	B-Length _____
C- Width _____	C-Width Front _____
	D-Width Rear _____

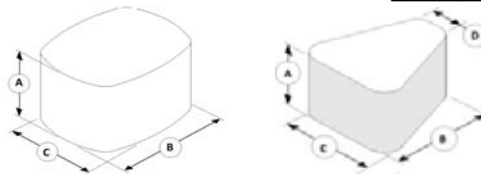

MISCELLANEOUS

25. ANTERIOR PELVIC BELTS	
Std. 2-point Push Button 1"	\$68 ea
<input type="checkbox"/> No Pad <input type="checkbox"/> 4.5" Pad <input type="checkbox"/> 5.5" Pad <input type="checkbox"/> 7.5" Pad	
Std. 2-point Push Button 1.5"	\$68 ea
<input type="checkbox"/> No Pad <input type="checkbox"/> 7.5" Pad <input type="checkbox"/> 9.5" Pad	
Medial 4-point Push Button 1.5"	\$68 ea
<input type="checkbox"/> 4.5" Pad <input type="checkbox"/> 5.5" Pad	
26. SHOE HOLDERS	
Style (Required)	
<input type="checkbox"/> Padded	\$180 pr
<input type="checkbox"/> Tendon Relief	\$180 pr
Size (Required)	
<input type="checkbox"/> S <input type="checkbox"/> L	
<input type="checkbox"/> M <input type="checkbox"/> XL	

27. ANTERIOR TRUNK SUPPORTS	
Style (Required)	
<input type="checkbox"/> Classic Comforfit Structured	\$180 ea
<input type="checkbox"/> Classic Comforfit Dynamic	\$180 ea
<input type="checkbox"/> Contour Comforfit Structured	\$180 ea
<input type="checkbox"/> Contour Comforfit Dynamic	\$180 ea
Size (Required)	
<input type="checkbox"/> Early Int. <input type="checkbox"/> M	
<input type="checkbox"/> XS <input type="checkbox"/> L	
<input type="checkbox"/> S <input type="checkbox"/> XL	
Strap Guide (Optional)	
<input type="checkbox"/> Strap Guide	\$52 ea

* - Must choose back upholstery on page 2.
** - Must choose seat upholstery on page 3.